

Single-Phase, Integrated Heatsink Type SSR [Left-Right Terminal]

■ Features

- Zero cross turn-on, random turn-on models available
- Input indicator (green LED)
- Alarm function (overheat prevention)
 - Rated load current 10A/15A/20A/25A: alarm indicator (red LED)
 - Rated load current 40A: alarm indicator (red LED), alarm output
- DIN rail mount or panel mount installation



⚠ Please read "Safety Considerations" in the instruction manual before using.



■ Ordering Information

SRH	L	1	-	1	4	40			
								Function	
								No mark	Zero cross turn-on
								R	Random turn-on
								Rated input current (resistive load)	
								10	10A
								15	15A
								20	20A
								25	25A
								40	40A
								Rated load voltage	
								2	24-240VAC
								4	48-480VAC
								Rated input voltage	
								1	10-30VDC
								4	90-240VAC
								Control phase	
								1	Single-phase
								Input/output terminal	
								L	Left-Right terminal
								Item	
								SRH	Solid State Relay (integrated heatsink type)

Model	Rated input voltage	Rated load current	Rated load voltage	Function	Alarm (overheat prevention)
SRHL1-1210	10-30VDC≡	10A	24-240VAC~	Zero cross turn-on	Alarm indicator
SRHL1-1215	10-30VDC≡				Alarm indicator
SRHL1-1215	10-30VDC≡	15A			Alarm indicator
SRHL1-1220	10-30VDC≡				Alarm indicator
SRHL1-1220	90-240VAC~	20A			Alarm indicator
SRHL1-1225	10-30VDC≡				Alarm indicator
SRHL1-1225	90-240VAC~	25A			Alarm indicator
SRHL1-1240	10-30VDC≡				Alarm indicator + Alarm output
SRHL1-1240	90-240VAC~	40A			Alarm indicator
SRHL1-1410	10-30VDC≡				10A
SRHL1-1410R	10-30VDC≡	Random turn-on			
SRHL1-1410	90-240VAC~	15A	Zero cross turn-on		
SRHL1-1415	10-30VDC≡		Random turn-on		
SRHL1-1415R	10-30VDC≡	20A	Zero cross turn-on		
SRHL1-1415	90-240VAC~		Random turn-on		
SRHL1-1420	10-30VDC≡	20A	Zero cross turn-on		
SRHL1-1420R	10-30VDC≡		Random turn-on		
SRHL1-1420	90-240VAC~	25A	Zero cross turn-on		
SRHL1-1425	10-30VDC≡		Random turn-on		
SRHL1-1425R	10-30VDC≡	40A	Zero cross turn-on		
SRHL1-1425	90-240VAC~		Random turn-on		
SRHL1-1440	10-30VDC≡	40A	Zero cross turn-on		
SRHL1-1440R	10-30VDC≡		Random turn-on		
SRHL1-1440	90-240VAC~	40A	Zero cross turn-on		
SRHL1-1440	90-240VAC~		Random turn-on		
SRHL1-1440	90-240VAC~	40A	Zero cross turn-on		
SRHL1-1440	90-240VAC~		Random turn-on		

SENSORS
CONTROLLERS
MOTION DEVICES
SOFTWARE

(J) Temperature Controllers
(K) SSRs
(L) Power Controllers
(M) Counters
(N) Timers
(O) Digital Panel Meters
(P) Indicators
(Q) Converters
(R) Digital Display Units
(S) Sensor Controllers
(T) Switching Mode Power Supplies
(U) Recorders
(V) HMIs
(W) Panel PC
(X) Field Network Devices

SRHL1 Series

■ Specifications

○ Input

Rated input voltage range	10-30VDC≡	90-240VACrms~ (50/60Hz)
Allowable input voltage range	9-32VDC≡	85-264VACrms~ (50/60Hz)
Max. input current	15mA	22mA
Pick-up voltage	Min. 9VDC≡	Min. 85VACrms~
Drop-out voltage	Max. 1VDC≡	Max. 10VACrms~
Turn-ON time	Zero cross turn-on Max. 0.5 cycle of load source + 1ms Random turn-on Max. 1ms	Max. 2 cycle of load source + 1ms —
Turn-off time	Max. 0.5 cycle of load source + 1ms	Max. 2 cycle of load source + 1ms

○ Output

Rated load voltage range	24-240VACrms~ (50/60Hz)					48-480VACrms~ (50/60Hz)					
Allowable load voltage range	24-264VACrms~ (50/60Hz)					48-528VACrms~ (50/60Hz)					
Rated load current	Resistive load (AC-51) ^{※1}	10Arms	15Arms	20Arms	25Arms	40Arms	10Arms	15Arms	20Arms	25Arms	40Arms
Min. load current		0.15Arms	0.15Arms	0.2Arms	0.2Arms	0.5Arms	0.5Arms	0.5Arms	0.5Arms	0.5Arms	0.5Arms
Max. 1 cycle surge current (60Hz)		160A	160A	250A	250A	400A	300A	300A	500A	500A	500A
Max. non-repetitive surge current (I _t , t=8.3ms)		130A ² s	130A ² s	300A ² s	300A ² s	910A ² s	350A ² s	350A ² s	1000A ² s	1000A ² s	1000A ² s
Peak voltage (non-repetitive)		600V					1200V (Zero cross turn-on), 1000V (Random turn-on)				
Leakage current (Ta=25°C)		Max. 10mArms (240VAC~/60Hz)					Max. 10mArms (480VAC~/60Hz)				
Output on voltage drop [Vpk] (max. load current)		Max. 1.6V									
Static off state dv/dt		500V/μs									

※1: AC-51 is utilization category at IEC 60947-4-3.

○ Alarm output (overheat prevention)

Rated input voltage range	10-30VDC≡	90-240VACrms~ (50/60Hz)
Load voltage	Max. 30VDC≡	Max. 30VDC≡
Load current	Max. 50mA	Max. 50mA
Turn-off time	Max. 50ms	Max. 100ms

※ Overheat prevention function: When SSR internal temperature is overheated, the load output is cut off to prevent internal device damage. The alarm indicator turns ON and alarm output turns ON.

※ Alarm output is only for the rated load current 40A model (SRHL1-□□40□□). In case of the rated load current 10A/15A/20A/25A models (SRHL1-□□10□□□□15□□□□20□□□□25□□), the alarm indicator turns ON, regardless of alarm output.

※ To clear alarm, cut OFF the input signal during over alarm output return time at the rated ambient temperature.

○ General specifications

Dielectric strength (Vrms)	• Input-output: 2500VAC 50/60Hz for 1 min • Input/output-case: 4000VAC 50/60Hz for 1 min	
Insulation resistance	Over 100MΩ (at 500VDC megger) (input-output, input/output-case)	
Indicator	Input indicator: green LED, alarm indicator: red LED	
Vibration	Mechanical	0.75mm amplitude at frequency of 10 to 55Hz (for 1 min) in each X, Y, Z direction for 1 hour
	Malfunction	0.5mm amplitude at frequency of 10 to 55Hz (for 1 min) in each X, Y, Z direction for 10 min
Shock	Mechanical	300m/s ² (approx. 30G) in each X, Y, Z direction for 3 times
	Malfunction	100m/s ² (approx. 30G) in each X, Y, Z direction for 3 times
Environment	Ambient temperature	-30 to 70°C, storage: -30 to 100°C (The rated load current capacity is different depending on ambient temperature. Refer to '■ SSR Derating Curve'.)
	Ambient humidity	45 to 85%RH, storage: 45 to 85%RH
Input terminal connection, alarm output terminal connection	Min. 1×0.5mm ² (1×AWG20), max. 1×4mm ² (1×AWG12) or 2×1.5mm ² (2×AWG16)	
Output terminal connection	• Rated load current 10A/15A/20A/25A: min. 1×0.75mm ² (1×AWG18), max. 1×6mm ² (1×AWG10) or 2×2.5mm ² (2×AWG14) • Rated load current 40A: min. 1×1.5mm ² (1×AWG16), max. 1×16mm ² (1×AWG6) or 2×6mm ² (2×AWG10) ※ Use wires compliant with load current capacity to connect to the terminal.	
Input terminal fixed torque	0.75 to 0.95N·m	
Output terminal fixed torque	• Rated load current 10A/15A/20A/25A: 1.0 to 1.35N·m • Rated load current 40A: 1.6 to 2.2N·m	
Approval	CE  US	
Weight ^{※1}	• Rated load current 10A/15A/20A/25A: approx. 270g (approx. 192g) • Rated load current 40A: approx. 468g (approx. 372g)	

※1: The weight includes packaging. The weight in parenthesis is for unit only.

※ Environment resistance is rated at no freezing or condensation.

※ For wiring the terminal, round terminal must be used.

Single-Phase, Integrated Heatsink Type SSR [Left-Right Terminal]

■ Dimensions

- Rated load current 10A/15A/20A/25A

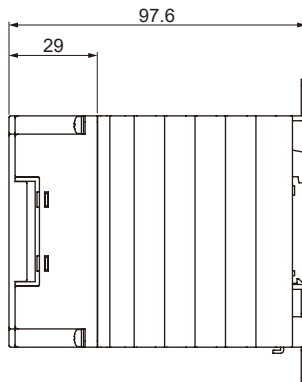
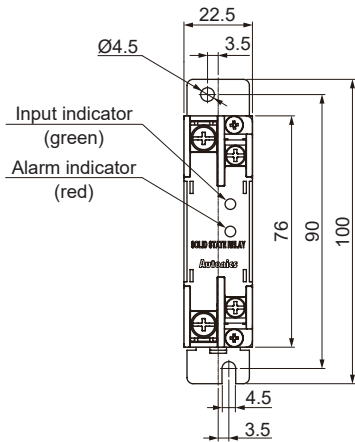

○ Panel cut-out

(unit: mm)

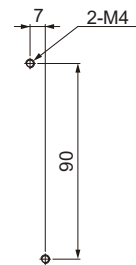

※Screw tightening torque for mounting : 1.8 to 2.5N·m

- Rated load current 40A

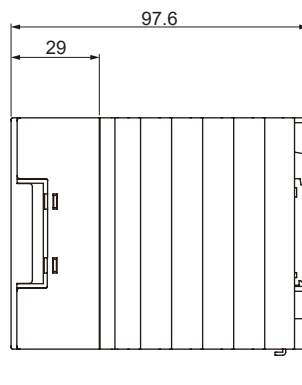
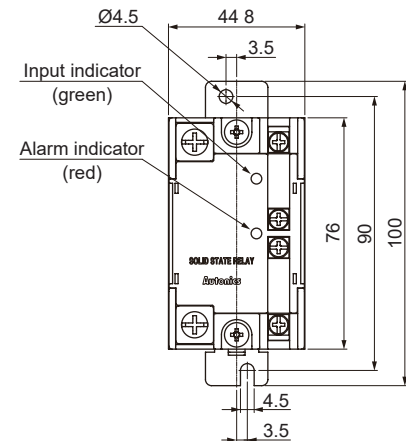

○ DIN rail mounting

- DIN rail attachment

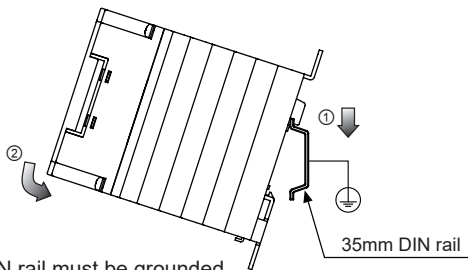

※DIN rail must be grounded.

- DIN rail detachment

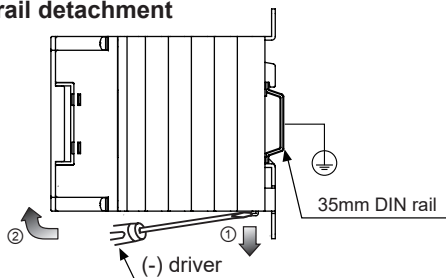

○ Spacing

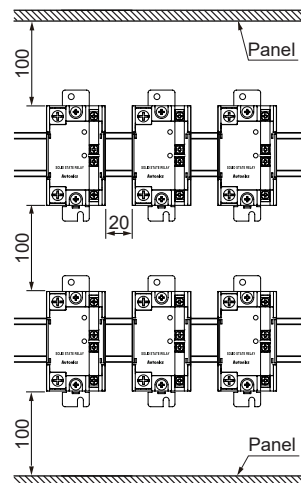

※When installing multiple SSRs, please keep space between SSRs for heat radiation. When installing SSRs horizontally (input part and output part on the same height), please supply less than 50% of the rated load current.

⚠ High temperature caution

While supplying power to the load or right after turning off the power of the load, do not touch the body and heat sink. Failure to follow this instruction may result in a burn due to high temperature.

SENSORS
CONTROLLERS
MOTION DEVICES
SOFTWARE
(J) Temperature Controllers
(K) SSRs
(L) Power Controllers
(M) Counters
(N) Timers
(O) Digital Panel Meters
(P) Indicators
(Q) Converters
(R) Digital Display Units
(S) Sensor Controllers
(T) Switching Mode Power Supplies
(U) Recorders
(V) HMIs
(W) Panel PC
(X) Field Network Devices

SRHL1 Series

■ Connections

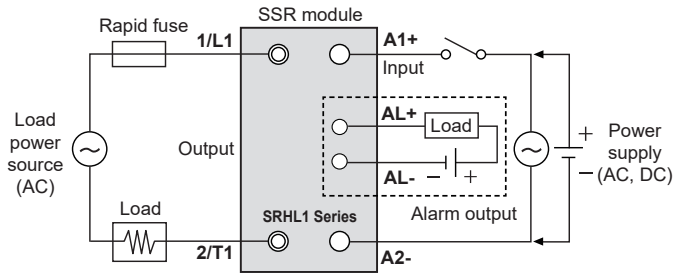

※ Alarm output terminals (AL+ and AL-) are only for the rated load current 40A model (SRHL1-□□40□).
 ※ Use terminals of size specified below.

Terminal type	Input, alarm output	Output	
Rated load current	10A, 15A, 20A, 25A, 40A	10A, 15A, 20A, 25A	40A
 <Round>	a	Min. 3.5mm	Min. 4.0mm
	b	Max. 7.0mm	Max. 9.0mm

■ SSR Derating Curve

◎ SRHL1-1210/1410/1410R/4210/4410

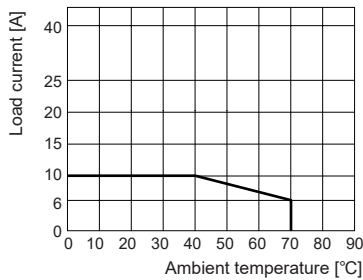

◎ SRHL1-1215/1415/1415R/4215/4415

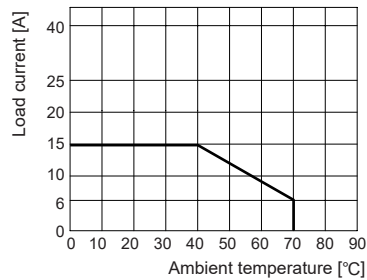

◎ SRHL1-1220/1420/1420R/4220/4420

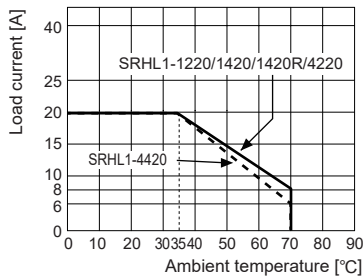

◎ SRHL1-1225/1425/1425R/4225/4425

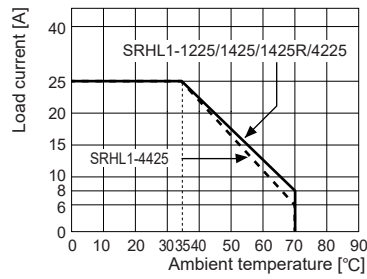

◎ SRHL1-1240/1440/1440R/4240/4440

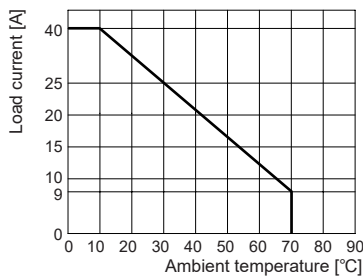

⚠ Since effectiveness of the heat radiation is decreased when multiple SSRs are installed closely, please supply less than 50% of the rated load current.

※ Above SSR derating curves obtained approval from the UL certification authority.

Single-Phase, Integrated Heatsink Type SSR [Left-Right Terminal]

■ Proper Usage

⚠ Cautions during use

1. Follow instructions in 'Cautions during use'. Otherwise, it may cause unexpected accidents.
2. 10-30VDC signal input should be insulated and limited voltage/current or Class 2, SELV power supply device.
3. Install the unit in the well ventilated place.
4. Ground to the heat sink, panel, or DIN rail.
Failure to follow this instruction may result in electric shock.
5. While supplying power to the load or right after turning off the power of the load, do not touch the body and heat sink.
Failure to follow this instruction may result in a burn due to the high temperature.
6. In order to protect the product from the short-circuit current of the load, use rapid fuse of which I^2t is under the 1/2 of SSR I^2t . When short-circuited, replace the fuse to those of same specification with the used rapid fuse.
7. Install dummy resistance in parallel with the load, to keep the sum of current flowing in the load and dummy resistance being over SSR minimum load current.
8. When using random turn-on model for phase control, install noise filter between the load and the power of the load.
9. Do not use near the equipment which generates strong magnetic force or high frequency noise.
10. This unit may be used in the following environments.
 - ① Indoors (in the environment condition rated in 'Specifications')
 - ② Altitude max. 2,000m
 - ③ Pollution degree 2
 - ④ Installation category III

SENSORS
CONTROLLERS
MOTION DEVICES
SOFTWARE

(J) Temperature Controllers
(K) SSRs
(L) Power Controllers
(M) Counters
(N) Timers
(O) Digital Panel Meters
(P) Indicators
(Q) Converters
(R) Digital Display Units
(S) Sensor Controllers
(T) Switching Mode Power Supplies
(U) Recorders
(V) HMIs
(W) Panel PC
(X) Field Network Devices