

Instruction Manual

Compact, self-contained photoelectric sensors in universal-style housing



- Advanced one-piece photoelectric sensors with exceptional long-range optical performance
- Compact housing with mounting versatility, via its popular 30 mm threaded barrel or side-mount holes
- 10 V DC to 30 V DC operation with bipolar discrete outputs, NPN and PNP
- Selectable Light or Dark Operate, depending on wiring
- Tough ABS/polycarbonate blend housing is rated to IEC IP67; NEMA 6
- Easy-to-see sensor status indicators: two status LEDs visible from 360°; extra-large Output indicator on back of sensor housing (except emitters) visible from long distance
- Opposed, retroreflective, polarized retroreflective, diffuse and fixed-field (200 mm, 400 mm, or 600 mm cutoff) models available
- Retroreflective, polarized retroreflective, and diffuse models have potentiometer on back of housing for easy sensor range adjustment
- Choose 2 m integral cable or M12 integral QD models

WARNING:



- **Do not use this device for personnel protection**
- Using this device for personnel protection could result in serious injury or death.
- This device does not include the self-checking redundant circuitry necessary to allow its use in personnel safety applications. A device failure or malfunction can cause either an energized (on) or de-energized (off) output condition.

QS30 Standard (DC) Models

Model ⁽¹⁾	Sensing Mode	Beam	Range ⁽²⁾	Output
QS30E (emitter)	Opposed	875 nm Infrared	60 m (200 ft)	N/A
QS30R (receiver)		Effective Beam: 18 mm (0.7 in)		
QS30LP	Polarized Retroreflective	630 nm Visible Red	8 m (26 ft)	Bipolar NPN/PNP
QS30LV	Retroreflective		12 m (40 ft)	
QS30D	Diffuse	940 nm Infrared	1 m (3.3 ft)	
QS30FF200	Fixed Field	680 nm Visible Red	200 mm (8 in)	
QS30FF400			400 mm (16 in)	
QS30FF600			600 mm (24 in)	

Fixed-Field Mode Overview

QS30 self-contained fixed-field sensors are small, powerful, visible red diffuse mode sensors with far-limit cutoff (a type of background suppression). Their high excess gain and fixed-field technology allow the detection of objects of low reflectivity while ignoring background surfaces.

The cutoff distance is fixed. Backgrounds and background objects must always be placed beyond the cutoff distance.

Fixed-Field Sensing – Theory of Operation

The WORLD-BEAM QS30 Series Sensor compares the reflections of its emitted light beam (E) from an object back to the sensor's two differently aimed detectors, R1 and R2. See "[Figure: Fixed-Field Concept](#)" on page 2. If the near detector's (R1) light signal is stronger than the far detector's (R2) light signal (see object A in the Figure below, closer than the cutoff distance), the sensor responds to the object. If the far detector's (R2) light signal is stronger than the near detector's (R1) light signal (see object B in the Figure below, beyond the cutoff distance), the sensor ignores the object.

(1)

Only standard 2 m (6.5 ft) cabled models are listed.

- To order the 9 m (30 ft) integral cable model, add suffix "W/30" to the model number (for example, QS30E W/30).
- To order the 5-pin integral M12 quick disconnect (QD), add suffix "Q" (for example, QS30EQ).

(2) Polarized Retroreflective and Retroreflective ranges are specified using a model BRT-84 retroreflector.

The cutoff distance for the QS30 is fixed at 200 mm, 400 mm, or 600 mm (8 in, 16 in, or 24 in). Objects lying beyond the cutoff distance are usually ignored, even if they are highly reflective. However, under certain conditions, it is possible to falsely detect a background object (see "Background Reflectivity and Placement" on page 2).

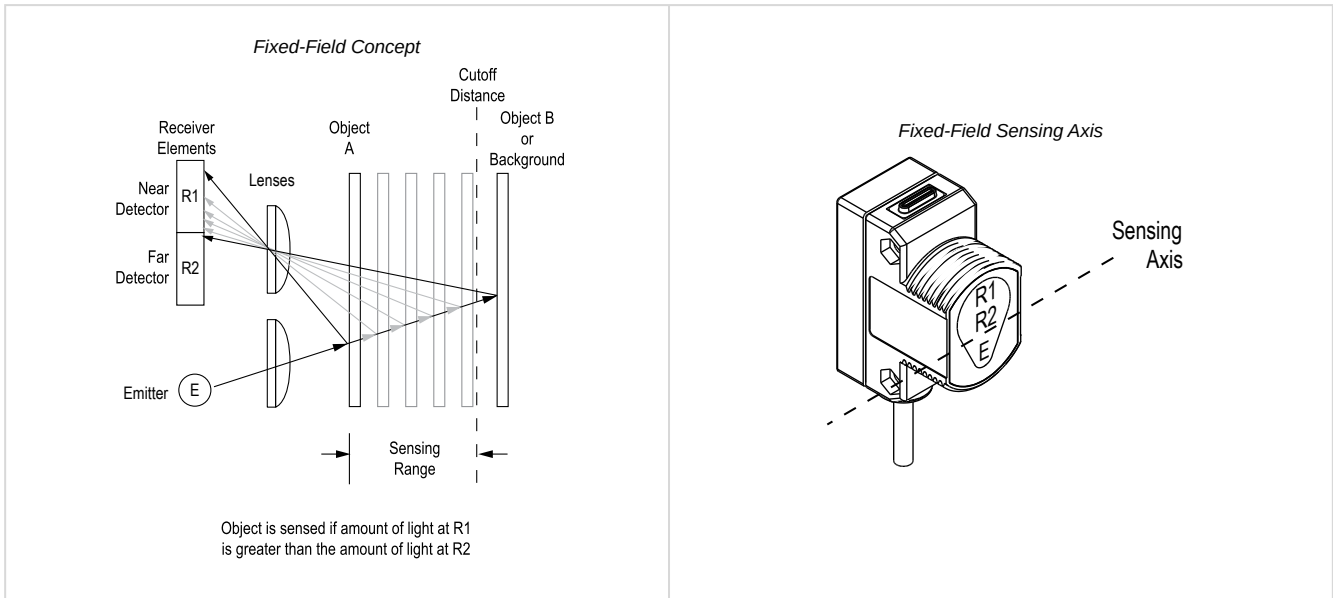

In the drawings and information provided in this document, the letters E, R1, and R2 identify how the sensor's three optical elements (Emitter "E", Near Detector "R1", and Far Detector "R2") line up across the face of the sensor. The location of these elements defines the sensing axis, see "Figure: Fixed-Field Sensing Axis" on page 2.

The sensing axis becomes important in certain situations, such as when the object is beyond the cutoff distance as shown in "Background Reflectivity and Placement" on page 2.

QS30 (DC) Wiring Diagrams

Cabled wiring diagrams are shown. Quick disconnect wiring diagrams are functionally identical.

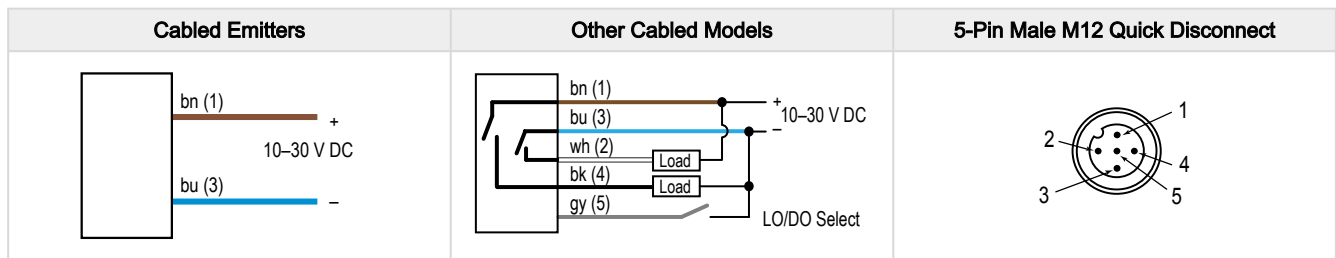

Configuring a Sensor

Sensing Reliability

For the highest sensitivity, position the target for sensing at or near the point of maximum excess gain. Refer to the Performance Curves for the excess gain. Sensing at or near this distance makes maximum use of each sensor's available sensing power. The background must be placed beyond the cutoff distance. Note that the reflectivity of the background surface also may affect the cutoff distance. Following these guidelines improves sensing reliability.

Background Reflectivity and Placement

Avoid mirror-like backgrounds that produce specular reflections. A false sensor response occurs if a background surface reflects the sensor's light more to the near detector (R1) than to the far detector (R2). The result is a false ON condition ("Figure: Reflective Background - Problem" on page 3). Correct this problem by using a diffusely reflective (matte) background or angling either the sensor or the background (in any plane) so the background does not reflect light back to the sensor ("Figure: Reflective Background - Solution" on page 3). Position the background as far beyond the cutoff distance as possible.

An object beyond the cutoff distance, either stationary (and when positioned as shown in "Figure: Object Beyond Cutoff - Problem" on page 3), or moving past the face of the sensor in a direction perpendicular to the sensing axis, may cause unwanted triggering of the sensor if more light is reflected to the near detector than to the far detector. Correct the problem by rotating the sensor 90° ("Figure: Object Beyond

Cutoff - Solution" on page 3). The object then reflects the R1 and R2 fields equally, resulting in no false triggering. A better solution, if possible, may be to reposition the object or the sensor.

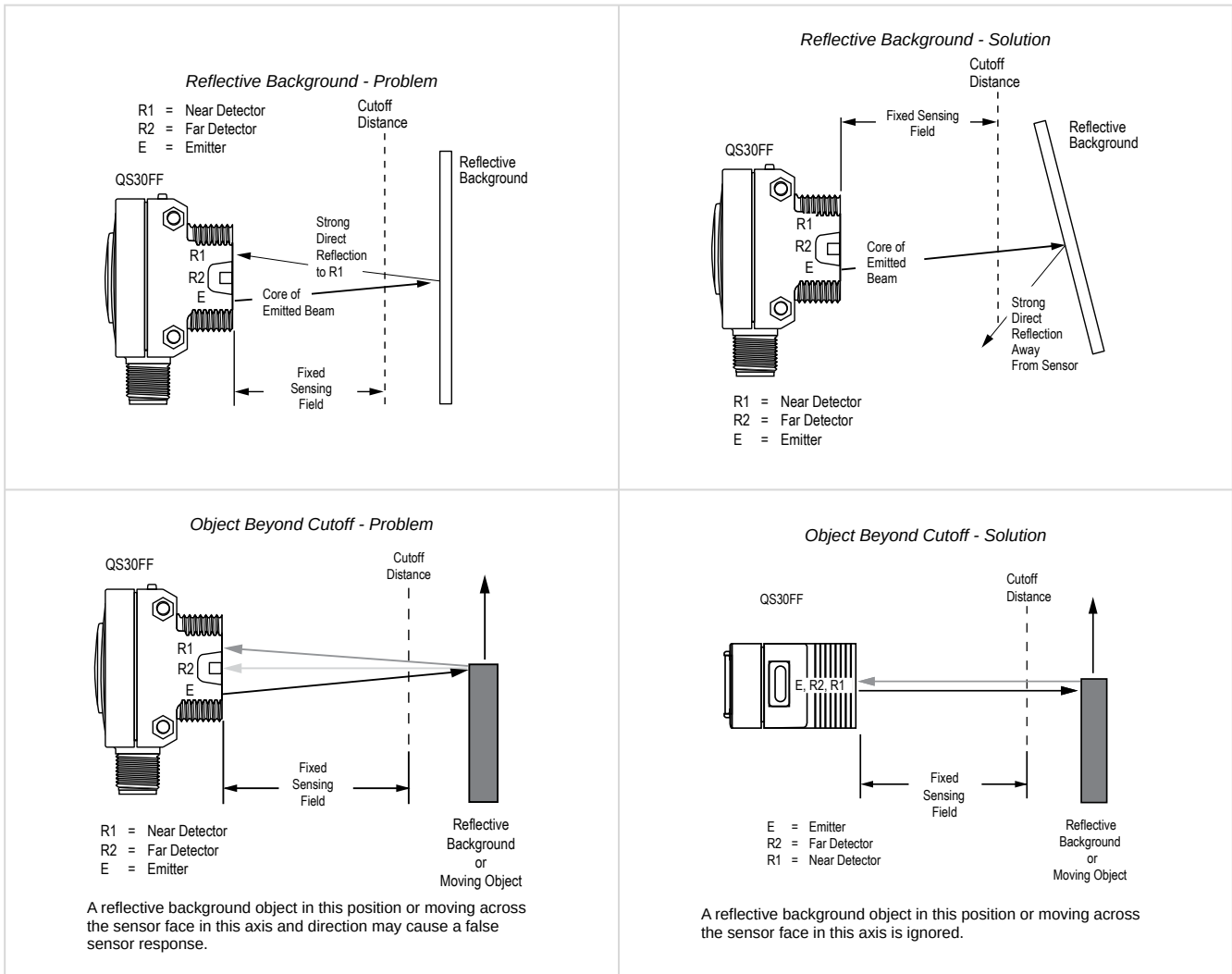

Color Sensitivity

may be important for some applications. It is expected that at any given cutoff setting, the actual cutoff distance for lower reflectance targets is slightly shorter than for higher reflectance targets. This behavior is known as color sensitivity.

For example, an excess gain of 1 for an object that reflects 1/10 as much light as the 90% white card is represented by the horizontal graph line at excess gain = 10. An object of this reflectivity results in a far-limit cutoff of approximately 190 mm (7.5 in) cutoff model, for example; and 190 mm (7.5 in) represents the cutoff for this sensor and target.

These excess gain curves were generated using a white test card of 90% reflectance. Objects with reflectivity of less than 90% reflect less light back to the sensor and thus require proportionately more excess gain to be sensed with the same reliability as more reflective objects. When sensing an object of very low reflectivity, it may be essential to sense it at or near the distance of maximum excess gain.

QS30 Standard (DC) Specifications

Supply Voltage

10 V DC to 30 V DC (10% max. ripple) at less than 40 mA, exclusive of load
Protected against reverse polarity and transient voltages

Output Response

Opposed Mode: 5 milliseconds ON and OFF
All others: 2 milliseconds
NOTE: 100 millisecond delay on power-up; outputs do not conduct during this time

Repeatability

Opposed Mode: not applicable
All others: 500 microseconds

Cutoff Point Tolerance

Fixed-Field only: $\pm 5\%$ of nominal cutoff distance

Construction and Mounting

ABS housing, rated IEC IP67; NEMA 6; Acrylic lens cover
3 mm mounting hardware included

Connections

2 m (6.5 ft) unterminated 5-wire PVC-jacketed cable; 9 m (30 ft) unterminated 5-wire PVC-jacketed cable ; or Integral 5-pin M12 male quick-disconnect connector

Application Tip for the QS30LV Model

For best sensing reliability, targets should be a minimum of 0.5m from the sensor

Output Configuration

Bipolar: One current sourcing and one current sinking
 Rating: 100 mA maximum each output at 25 °C

Off-state leakage current:
 NPN: less than 50 µA
 PNP: less than 40 µA

ON-state saturation voltage:
 NPN: less than 3 V at 100 mA
 PNP: less than 3 V at 100 mA

Protected against false pulse on power-up and continuous overload or short circuit of outputs

Adjustments

Selectable Light/Dark Operate is achieved via the gray wire. Opposed, Retroreflective, and Polarized Retroreflective models:

Light Operate - Low (0 V to 3 V)*
 Dark Operate - High (open or 5 V to 30 V)*

Diffuse and Fixed-Field models:
 Light Operate - High (open or 5 V to 30 V)*
 Dark Operate - Low (0 V to 3 V)*

Diffuse, Retroreflective, and Polarized Retroreflective mode models (only):

Single-turn Sensitivity (Gain) adjustment potentiometer

* Input impedance 10 kΩ

Indicators

2 LEDs on sensor top:
 Green on: Power on
 Green flashing: Output overloaded (except receivers)
 Amber on: Light sensed
 Amber flashing: Marginal excess gain (1–1.5× excess gain)
 Large oval LED on sensor back (except emitters): Yellow on indicates the output is conducting

Operating Conditions

-20 °C to +70 °C (-4 °F to +158 °F)
 95% at +50 °C maximum relative humidity (non-condensing)

Vibration and Mechanical Shock

All models meet MIL-STD-202F, Method 201A (Vibration: 10 Hz to 60 Hz maximum, 0.06 inch (1.52 mm) double amplitude, 10G maximum acceleration) requirements. Also meets IEC 60947-5-2 (Shock: 30G 11 ms duration, half sine wave) requirements.

Certifications

 Banner Engineering BV
 Park Lane, Culliganlaan 2F bus 3
 1831 Diegem, BELGIUM



Required Overcurrent Protection



WARNING: Electrical connections must be made by qualified personnel in accordance with local and national electrical codes and regulations.

Overcurrent protection is required to be provided by end product application per the supplied table. Overcurrent protection may be provided with external fusing or via Current Limiting, Class 2 Power Supply. Supply wiring leads < 24 AWG shall not be spliced. For additional product support, go to Key definition for "{keyrefName}" not found in the DITA map..

Supply Wiring (AWG)	Required Overcurrent Protection (A)	Supply Wiring (AWG)	Required Overcurrent Protection (A)
20	5.0	26	1.0
22	3.0	28	0.8
24	1.0	30	0.5

QS30 Standard (DC) Performance Curves

For the diffuse models, the performance is based on using a 90% reflectance white test card.

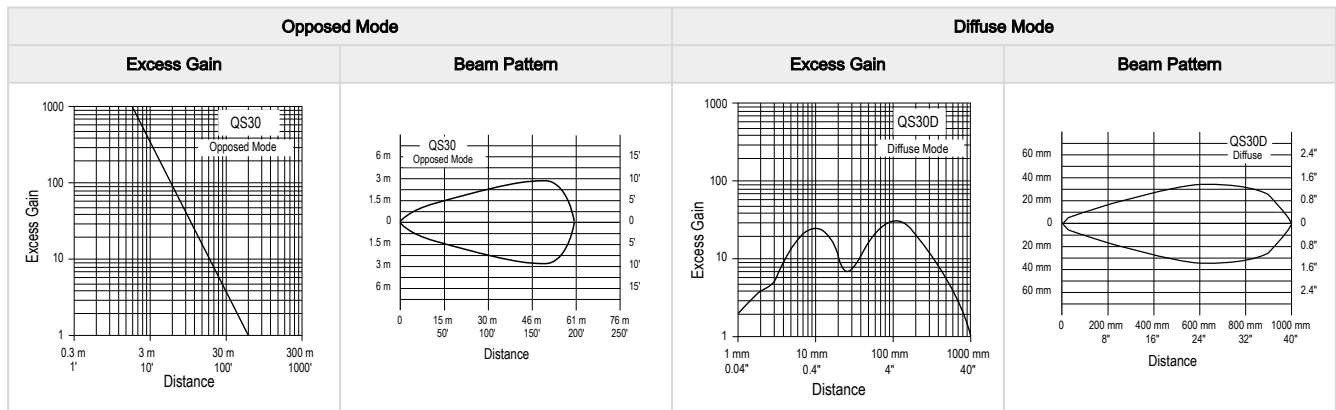

For the polarized retroreflective and retroreflective models, the performance is based on using the specified retroreflector.

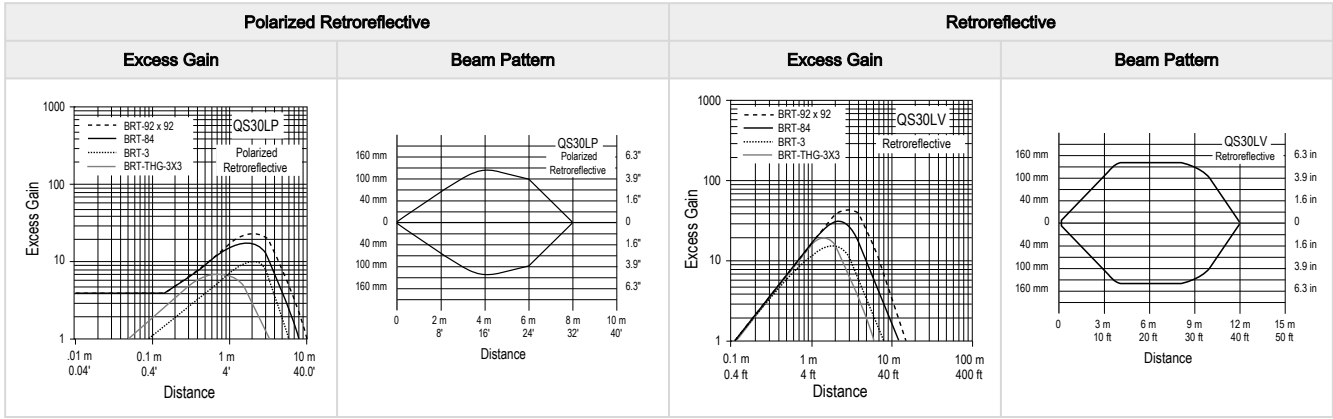

Fixed field performance is based on using a 90% reflectance white test card.

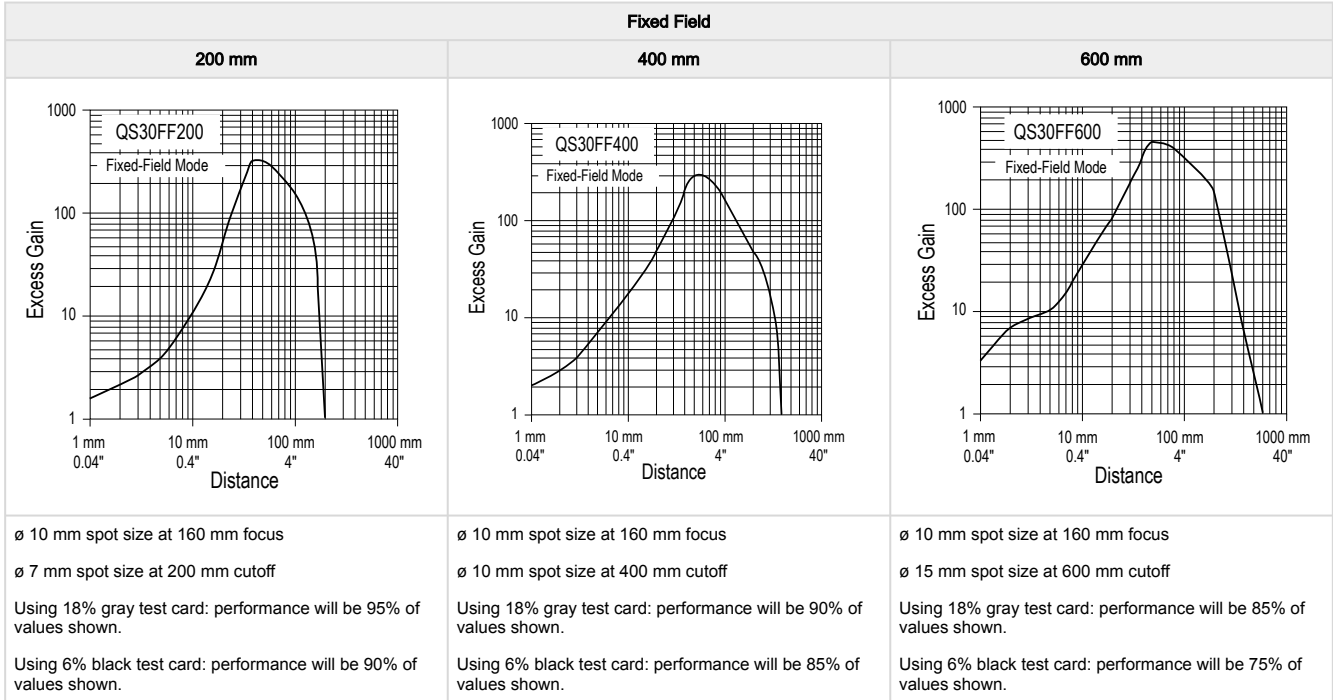

QS30 Standard (DC) Dimensions

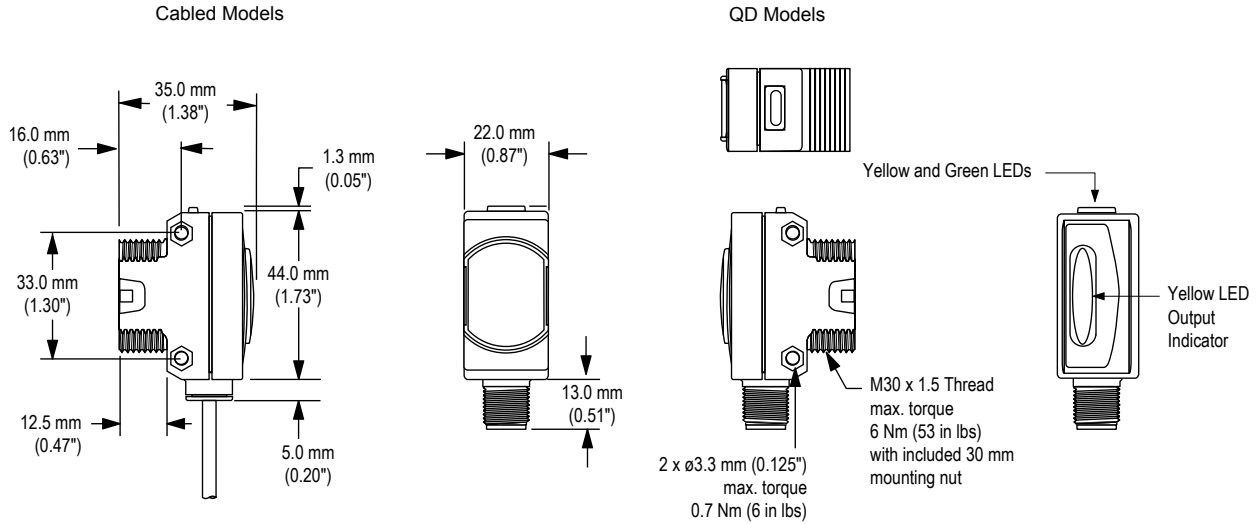

All measurements are listed in millimeters [inches], unless noted otherwise.

Accessories

Quick-Disconnect Cables

5-Pin Threaded M12 Cordsets—Single Ended				
Model	Length	Style	Dimensions	Pinout (Female)
MQDC1-501.5	0.5 m (1.5 ft)	Straight		
MQDC1-503	0.9 m (2.9 ft)			
MQDC1-506	2 m (6.5 ft)			
MQDC1-515	5 m (16.4 ft)			
MQDC1-530	9 m (29.5 ft)			
MQDC1-560	18 m (59 ft)			
MQDC1-5100	31 m (101.7 ft)			
MQDC1-506RA	2 m (6.5 ft)	Right-Angle		
MQDC1-515RA	5 m (16.4 ft)			
MQDC1-530RA	9 m (29.5 ft)			
MQDC1-560RA	19 m (62.3 ft)			

Sensor Status Indicators

S15L Series In-Line Sensor Status Indicator						
Model	Input Type	LED Color	Dimensions	Female	Male	Wiring
S15LGYPQ	PNP	Power ON = Green Input Active = Yellow				1 = Brown, 10 to 30 V DC 2 = White 3 = Blue, DC common 4 = Black, Sensor Input
S15LGYNQ	NPN					

Brackets for the QS30 Standard DC Sensor

SMBQS30L

- Right-angle bracket for cable sensor models
- Clearance for M4 (#8) hardware
- ± 12° tilt adjustment
- 14-gauge stainless steel

Hole center spacing: A to B=35.0

Hole size: A=∅ 4.3, B=∅ 4.25×16.3



SMBQS30LT

- Tall right-angle bracket for QD models
- ± 8° tilt adjustment
- 14-gauge stainless steel

Hole center spacing: A to B=35.0

Hole size: A=∅ 4.3, B=∅ 4.25×16.3



SMBQS30Y

- Heavy-duty die-cast bracket
- M18 vertical mount option
- ± 8° tilt adjustment with cabled units
- Includes nuts and lock washer

Hole size: A=∅ 15.3



SMBQS30YL

- Heavy-duty die-cast bracket designed for industrial protection
- M18 vertical mount option
- Replaceable window
- Includes nuts and lock washer

Hole size: A=∅ 15.3

SMB30A

- Right-angle bracket with curved slot for versatile orientation
- Clearance for M6 (¼ in) hardware
- Mounting hole for 30 mm sensor
- 12-gauge stainless steel

Hole center spacing: A to B=40

Hole size: A=∅ 6.3, B= 27.1 × 6.3, C=∅ 30.5

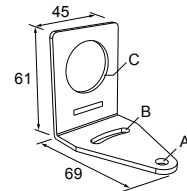

SMB30MM

- 12-gauge stainless steel bracket with curved mounting slots for versatile orientation
- Clearance for M6 (¼ in) hardware
- Mounting hole for 30 mm sensor

Hole center spacing: A = 51, A to B = 25.4

Hole size: A = 42.6 × 7, B = ∅ 6.4, C = ∅ 30.1

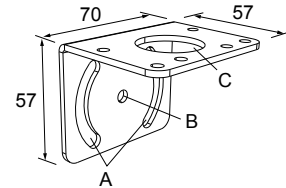

SMB30SC

- Swivel bracket with 30 mm mounting hole for sensor
- Black reinforced thermoplastic polyester
- Stainless steel mounting and swivel locking hardware included

Hole center spacing: A=∅ 50.8

Hole size: A=∅ 7.0, B=∅ 30.0

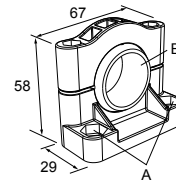

All measurements are listed in millimeters [inches], unless noted otherwise.

QS30 Apertures

Opposed-mode QS30 sensors may be fitted with apertures to narrow or shape the sensor's effective beam to more closely match the size or profile of the objects being sensed. A common example is the use of "line" (or "slot") type apertures to sense thread.

NOTE: The use of apertures reduces the sensing range.

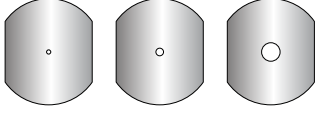
Model	Aperture Description	Pieces	
APQS30-040	1 mm (0.04 in) diameter, circular	6	
APQS30-100	2.5 mm (0.10 in) diameter, circular	6	
APQS30-200	5 mm (0.20 in) diameter, circular	6	

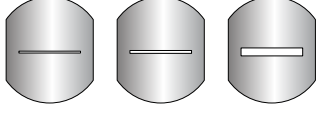
Model	Aperture Description	Pieces	
APQS30-040H	1 × 12 mm (0.04 in × 0.47 in), horizontal slot	6	
APQS30-100H	2.5 × 12 mm (0.10 in × 0.47 in), horizontal slot	6	
APQS30-200H	5 × 12 mm (0.20 in × 0.47 in), horizontal slot	6	

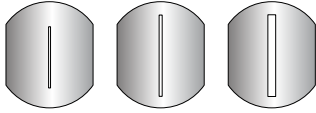
Model	Aperture Description	Pieces	
APQS30-040V	1 × 17 mm (0.04 in × 0.67 in), vertical slot	6	
APQS30-100V	2.5 × 17 mm (0.10 in × 0.67 in), vertical slot	6	
APQS30-200V	5 × 17 mm (0.20 in × 0.67 in), vertical slot	6	
APQS30-DVHX2	Kit containing two of each aperture above	18	
APQS30-DVH	Kit containing one each of aperture models: APQS30-040, APQS30-040H, APQS30-040V	18	

Reduced Range for QS30E and QS30R Pair with Apertures

Aperture Model	Maximum Range	
	Aperture on Both Emitter and Receiver	Aperture on Receiver Only
APQS30-040	0.5 m (1.5 ft)	4.1 m (13.5 ft)
APQS30-100	2.4 m (8 ft)	14.3 m (47 ft)
APQS30-200	11.6 m (38 ft)	23.5 m (77 ft)
APQS30-040H	7 m (23 ft)	16.8 m (55 ft)
APQS30-100H	16.5 m (54 ft)	24.7 m (81 ft)
APQS30-200H	28.7 m (94 ft)	36.6 m (120 ft)
APQS30-040V	7 m (23 ft)	16.8 m (55 ft)
APQS30-100V	16.5 m (54 ft)	24.7 m (81 ft)
APQS30-200V	28.7 m (94 ft)	36.6 m (120 ft)

Example: The QS30E/QS30R sensor pair is used with apertures APQS30-040. Using the circular aperture on only the receiver, the range reduces to 4.1 m (13.5 ft). When the APQS30-040 aperture is installed on both the receiver and emitter, the sensor range reduces to 0.5 m (1.5 ft).

Retroreflective Targets

Banner offers a wide selection of high-quality retroreflective targets. See www.bannerengineering.com for complete information.

NOTE: Polarized sensors require corner cube-type retroreflective targets. Non-polarized sensors may use any retroreflective target.



Banner Engineering Corp Limited Warranty

Banner Engineering Corp. warrants its products to be free from defects in material and workmanship for one year following the date of shipment. Banner Engineering Corp. will repair or replace, free of charge, any product of its manufacture which, at the time it is returned to the factory, is found to have been defective during the warranty period. This warranty does not cover damage or liability for misuse, abuse, or the improper application or installation of the Banner product.

THIS LIMITED WARRANTY IS EXCLUSIVE AND IN LIEU OF ALL OTHER WARRANTIES WHETHER EXPRESS OR IMPLIED (INCLUDING, WITHOUT LIMITATION, ANY WARRANTY OF MERCHANTABILITY OR FITNESS FOR A PARTICULAR PURPOSE), AND WHETHER ARISING UNDER COURSE OF PERFORMANCE, COURSE OF DEALING OR TRADE USAGE.

This Warranty is exclusive and limited to repair or, at the discretion of Banner Engineering Corp., replacement. **IN NO EVENT SHALL BANNER ENGINEERING CORP. BE LIABLE TO BUYER OR ANY OTHER PERSON OR ENTITY FOR ANY EXTRA COSTS, EXPENSES, LOSSES, LOSS OF PROFITS, OR ANY INCIDENTAL, CONSEQUENTIAL OR SPECIAL DAMAGES RESULTING FROM ANY PRODUCT DEFECT OR FROM THE USE OR INABILITY TO USE THE PRODUCT, WHETHER ARISING IN CONTRACT OR WARRANTY, STATUTE, TORT, STRICT LIABILITY, NEGLIGENCE, OR OTHERWISE.**

Banner Engineering Corp. reserves the right to change, modify or improve the design of the product without assuming any obligations or liabilities relating to any product previously manufactured by Banner Engineering Corp. Any misuse, abuse, or improper application or installation of this product or use of the product for personal protection applications when the product is identified as not intended for such purposes will void the product warranty. Any modifications to this product without prior express approval by Banner Engineering Corp will void the product warranties. All specifications published in this document are subject to change; Banner reserves the right to modify product specifications or update documentation at any time. Specifications and product information in English supersede that which is provided in any other language. For the most recent version of any documentation, refer to: www.bannerengineering.com.

For patent information, see www.bannerengineering.com/patents.

Document title: WORLD-BEAM® QS30 Standard Series (DC Voltage) Instruction Manual
 Part number: 119165
 Revision: F
 Original Instructions
 © Banner Engineering Corp. All rights reserved.

