

U-GAGE® T30UX Series with Discrete Output



Datasheet

Ultrasonic sensor with TEACH-mode configuration



- 1, 2, and 3 m (3.28, 6.56, and 9.84 ft) versions with short dead zones (10% of max range)
- Built-in temperature compensation
- Fast, easy-to-use TEACH-Mode programming; no potentiometer adjustments
- Remote TEACH for security and convenience
- Wide operating temperature range of $-40\text{ }^{\circ}\text{C}$ to $+70\text{ }^{\circ}\text{C}$ ($-40\text{ }^{\circ}\text{F}$ to $+158\text{ }^{\circ}\text{F}$)
- Outputs can be set for either NPN or PNP, Normally Open (N.O.) or Normally Closed (N.C.)
- Compact, self-contained, right-angle sensor package with fully encapsulated electronics

Models

Models	Range and Frequency	Cable ¹	Discrete Output	Response Time
T30UXDA	100 mm to 1 m (3.9 in to 39 in) 224 kHz	Standard 2 m (6.5 ft) cable	NPN, PNP, NO, NC, Selectable	45 ms
T30UXDB	200 mm to 2 m (7.8 in to 78 in) 174 kHz			92 ms
T30UXDC	300 mm to 3 m (11.8 in to 118 in) 114 kHz			135 ms



WARNING:

- **Do not use this device for personnel protection**
- Using this device for personnel protection could result in serious injury or death.
- This device does not include the self-checking redundant circuitry necessary to allow its use in personnel safety applications. A device failure or malfunction can cause either an energized (on) or de-energized (off) output condition.

Overview

The U-GAGE® T30UX is an easy-to-use ultrasonic sensor with extended range and built-in temperature compensation. Simple push button configuration provides flexibility for a variety of applications.

Easy-to-see indicator LEDs communicate the status of the sensor. The Green "Power" LED ON indicates that the sensor is in Run Mode (the sensor's normal operating condition). The Red "Signal" LED indicates the target signal strength. The Amber "Output" LED indicates that the output is enabled and the sensor is receiving a signal within the window limits (depending on NO or NC). The Amber "Mode" LED indicates the currently selected mode.

Figure 1. Features



¹ Only standard 2 m (6.5 ft) cable models are listed. To order the 4-pin M12 integral QD, add the suffix "Q8" to the model number (for example, T30UXDAQ8). To order the 150 mm (6 in) PUR cable with a 4-pin M12 QD, add the suffix "QPMA" to the model number (for example, T30UXDAQPMA). To order the 9 m (30 ft) cable, add the suffix "W/30" to the model number (for example, T30UXDA W/30). A model with a QD connector requires a mating cable. See [Accessories](#) on page 11.



Principles of Operation

Ultrasonic sensors emit one or multiple pulses of ultrasonic energy, which travel through the air at the speed of sound. A portion of this energy reflects off the target and travels back to the sensor. The sensor measures the total time required for the energy to reach the target and return to the sensor. The distance to the object is then calculated using the following formula: **D = ct ÷ 2**

D = distance from the sensor to the target

c = speed of sound in air

t = transit time for the ultrasonic pulse

To improve accuracy, an ultrasonic sensor may average the results of several pulses before outputting a new value.

Temperature Effects

The speed of sound is dependent upon the composition, pressure and temperature of the gas in which it is traveling. For most ultrasonic applications, the composition and pressure of the gas are relatively fixed, while the temperature may fluctuate.

In air, the speed of sound varies with temperature according to the following approximation:

In metric units: $C_{m/s} = 20 \sqrt{273 + T_C}$

In English units: $C_{ft/s} = 49 \sqrt{460 + T_F}$

C_{m/s} = speed of sound in meters per second

C_{ft/s} = speed of sound in feet per second

T_C = temperature in °C

T_F = temperature in °F

Temperature Compensation

Changes in air temperature affect the speed of sound, which in turn affects the total time for the echo measured by the sensor. An increase in air temperature shifts both sensing window limits closer to the sensor. Conversely, a decrease in air temperature shifts both limits farther away from the sensor. This shift is approximately 3.5% of the limit distance for a 20° C change in temperature.

The T30UX series ultrasonic sensors are temperature compensated. This reduces the error due to temperature by about 90%. The sensor will maintain its window limits to within 2.2% over the -40° to +70° C (-40° to +158° F) operating range of the sensor.



Note:

- Exposure to direct sunlight can affect the sensor’s ability to accurately compensate for changes in temperature.
- If the sensor is measuring across a temperature gradient, the compensation will be less effective.

Configuration Instructions

Sensor Configuration

Two TEACH methods may be used to configure the sensor:

- Teach individual minimum and maximum limits, or
- Use Auto-Window feature to center a sensing window around the taught position.

The sensor may be configured either via its push button, or via a remote switch. Remote configuration also may be used to disable the push button, preventing unauthorized personnel from adjusting the configuration settings. To access this feature, connect the white wire of the sensor to 0V dc, with a remote configuration switch between the sensor and the voltage.

Configuration is accomplished by following the sequence of input pulses. The duration of each pulse (corresponding to a push button “click”), and the period between multiple pulses, are as “T”: **0.04 seconds < T < 0.8 seconds**

Remote line configuration requires a greater than 1 second pause between pulse sequences.

Mode Setup - Output Configuration

Sensors can be set up for either NPN (sinking) or PNP (sourcing). In addition, the user can select between Normally Open (N.O.) and Normally Closed (N.C.) operation. Normally Open is defined as the output energizing when the target is present. Normally Closed is defined as the output energizing when the target is absent (see [Teaching Minimum and Maximum Limits](#) on page 3). A button click or pulse on the remote line is: 0.04 s < T < 0.8 s.

1. Enter Output Configuration setup mode.

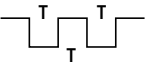
Method	Action	Result
Push Button	Push and hold the MODE button for more than 2 seconds.	Power LED: OFF Mode LED: Flashing Amber shows previously selected mode
Remote Input	Double-pulse the remote line. 	Power LED: OFF Mode LED: Flashing Amber shows previously selected mode

2. Select the output.

Method	Action	Result
Push Button	Click the MODE button to cycle to select the output configuration: <ul style="list-style-type: none"> • NPN - Normally Open • NPN - Normally Closed • PNP - Normally Open • PNP - Normally Closed 	Power LED: OFF Mode LED: Flashes to indicate currently selected mode (120 second time out ²)
Remote Input	<ul style="list-style-type: none"> • Single-pulse for NPN - Normally Open • Double-pulse for NPN - Normally Closed • Triple-pulse for PNP - Normally Open • Quad-pulse for PNP - Normally Closed 	Power LED: ON Green Mode LED: ON to indicate currently selected mode (Sensor returns to RUN mode)

3. Save and return to Run mode.

Method	Action	Result
Push Button	Push and hold the MODE button for more than 2 seconds.	Power LED: ON Green Mode LED: ON Amber for selected mode
Remote Input	No action required; the sensor returns to Run Mode automatically.	None

Teaching Minimum and Maximum Limits

General Notes on Teaching

- The sensor returns to RUN mode if the first TEACH condition is not registered within 120 seconds after the initial 2 second hold on the Discrete button.
- To exit TEACH mode without saving any changes, press and hold the Discrete button or remote line longer than 2 seconds (before teaching the second limit). The sensor reverts to the last saved limits.
- After the first limit is taught, the sensor remains in TEACH mode until the TEACH sequence is finished or exited by a 2 second hold on the Discrete button or remote line.
- A button click or pulse on the remote line is: 0.04 s < T < 0.8 s.

Figure 2. Teaching independent minimum and maximum limits

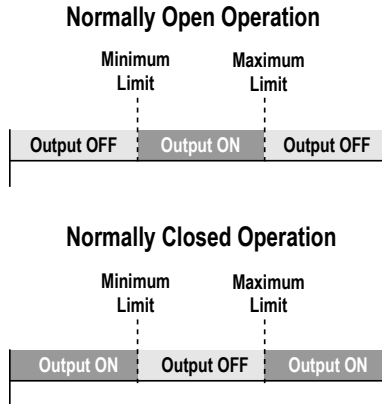

1. Enter TEACH mode.

Method	Action	Result
Push Button	Push and hold the Discrete push button longer than 2 seconds.	Power LED: OFF Output LED: ON
Remote Input	No action required; sensor is ready for first limit teach.	None

² The sensor will revert to previously saved configuration and return to RUN mode if TEACH is inactive for 120 seconds after the initial 2 second hold on push button

2. Teach the first limit.

Method	Action	Result
Push Button	Position the target for the first limit (120 second time out).	Signal LED: Must be ON Red or Flashing Red ³
	“Click” the Discrete button.	Teach Accepted Power LED: OFF Output LED: Flashing Teach Not Accepted Output LED: ON
Remote Input	Position the target for the first limit.	Signal LED: Must be ON Red or Flashing Red ³
	Single-pulse the remote line. 	Teach Accepted Power LED: OFF Output LED: Flashing Teach Not Accepted Power LED: ON

3. Teach the second limit.

Method	Action	Result
Push Button	Position the target for the second limit (no time out).	Signal LED: Must be ON Red or Flashing Red
	“Click” the Discrete button.	Teach Accepted Output LED: ON or OFF, depending on NO or NC Mode Power LED: ON Teach Not Accepted Output LED: Flashing Power LED: OFF
Remote Input	Position the target for the second limit (no time out).	Signal LED: Must be ON Red or Flashing Red.
	Single-pulse the remote line. 	Teach Accepted Output LED: ON or OFF, depending on NO or NC Mode Power LED: ON Teach Not Accepted Output LED: Flashing Power LED: OFF

Teaching Limits Using the Auto-Window Feature

Teaching the same limit twice automatically centers a window on the taught position (see [Figure 4](#) on page 5 for window sizes).

General Notes on Teaching

- The sensor returns to RUN mode if the TEACH condition is not registered within 120 seconds after the initial 2 second hold on the Discrete button.
- To exit TEACH mode without saving any changes, press and hold the Discrete button or remote line longer than 2 seconds (before teaching the second limit). The sensor will revert to the last saved limits.
- After the first limit is taught, the sensor remains in TEACH mode until the TEACH sequence is finished or exited by a 2 second hold on the Discrete button or remote line.
- A button click or pulse on the remote line is: $0.04\text{ s} < T < 0.8\text{ s}$.

³ Sensor will not Teach or indicate “Teach Not Accepted” when there is no signal present (Signal LED Red or Flashing Red)

Figure 3. Using the Auto-Window feature for teaching each output

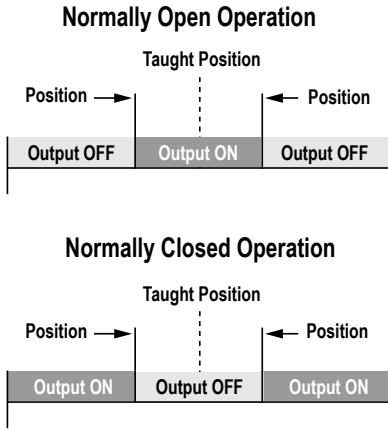

Figure 4. Window Size

Models	Window
"A" suffix	± 10 mm (0.4 in)
"B" suffix	± 20 mm (0.8 in)
"C" suffix	± 30 mm (1.2 in)

1. Enter TEACH mode.

Method	Action	Result
Push Button	Push and hold the Discrete button longer than 2 seconds.	Power LED: OFF Output LED: ON
Remote Input	No action required; the sensor is ready for the first limit teach.	None

2. Teach the first limit.

Method	Action	Result
Push Button	Position the target for the center of window (120 second time out).	Signal LED: Must be ON Red or Flashing Red ⁴
	Click the Discrete push button.	Teach Accepted Power LED: OFF Output LED: Flashing Teach Not Accepted Output LED: ON
Remote Input	Position the target for the center of window.	Signal LED: Must be ON Red or Flashing Red ⁴
	Single-pulse the remote line.	Teach Accepted Power LED: OFF Output LED: Flashing Teach Not Accepted Output LED: ON



3. Re-teach the limit.

Method	Action	Result
Push Button	Without moving the target, "click" the Discrete push button again	Teach Accepted Output LED: ON or OFF, depending on NO or NC Mode Power LED: ON Teach Not Accepted Output LED: Flashing Power LED: OFF
Remote Input	Without moving the target, single-pulse the remote line again.	Teach Accepted Output LED: ON or OFF, depending on NO or NC Mode Power LED: ON Teach Not Accepted Output LED: Flashing Power LED: OFF



⁴ Sensor will not Teach or indicate "Teach Not Accepted" when there is no signal present (Signal LED Red or Flashing Red)

Figure 5. An application for the Auto-Window feature (retroreflective mode)

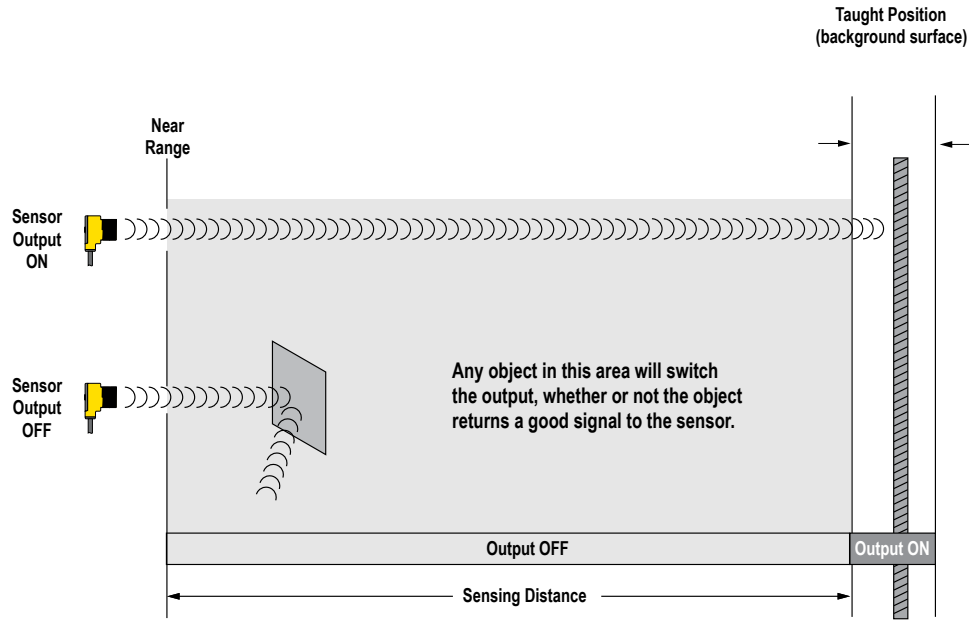

Remote Line TEACH

General Notes

- Run Mode is the sensor's normal operating condition
- The duration of each Pulse is defined as "T": $0.04 < T < 0.8 \text{ s}$ 
- A Hold will exit TEACH MODE and return to Run Mode with previously saved changes. The duration of a Hold is: $T > 2 \text{ s}$
- A Timeout will occur if a condition is not registered within 120 seconds, causing the sensor to return to Run Mode (during sensor configuration only)
- Sensor configuration user feedback shown on Green LED. See flowchart.
- The Red Signal LED will be ON whenever the target is in view.

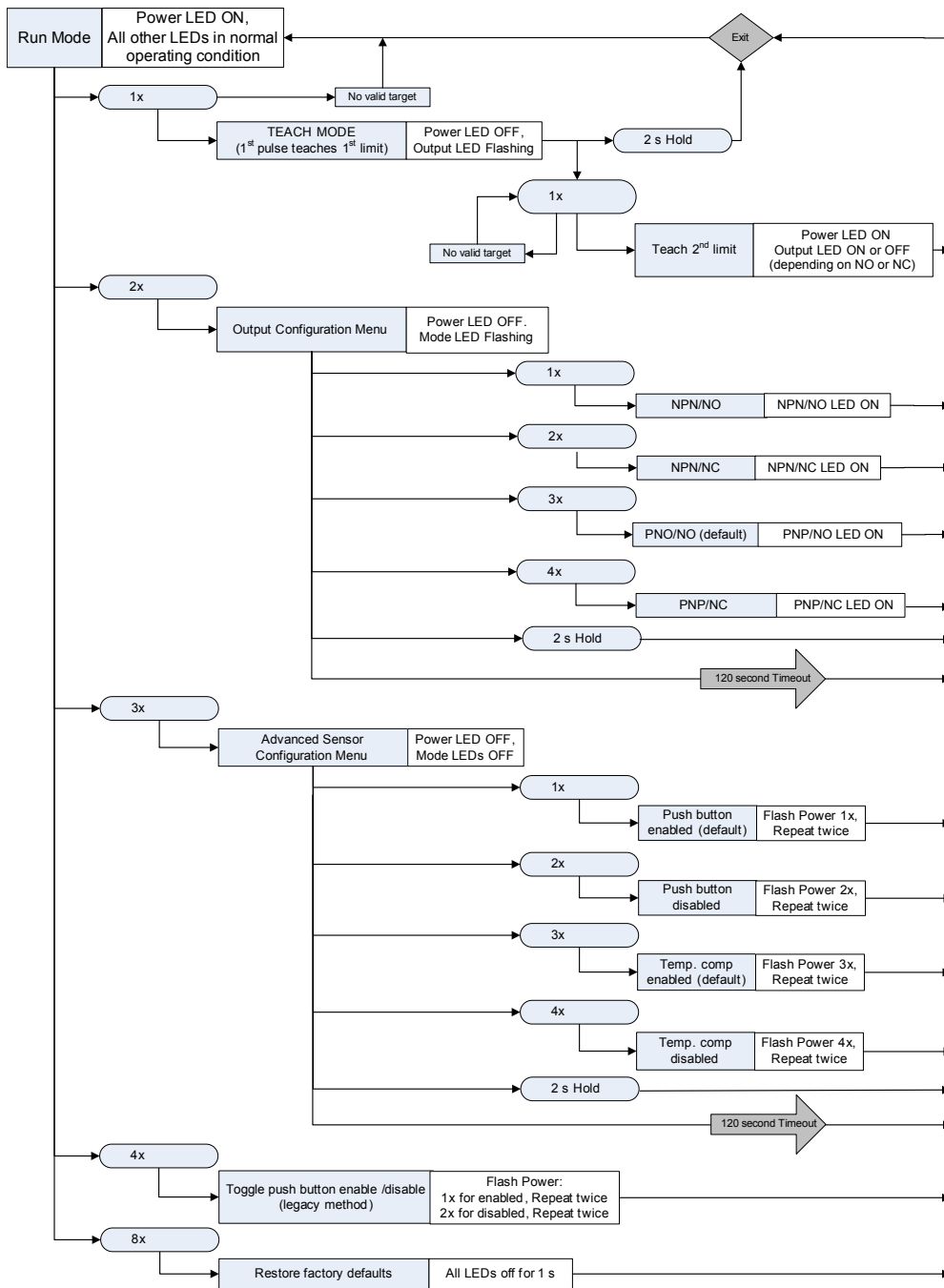

Wiring

Cabled and quick disconnect (QD) connector wiring is functionally identical. Shielded cordsets are recommended for all QD models.

Figure 6. NPN (sinking) output selected

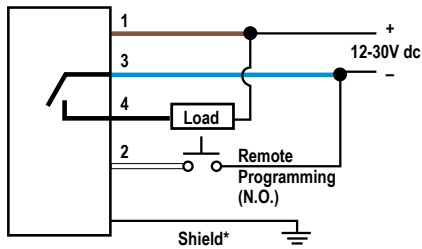

* It is recommended that the shield wire be connected to either earth ground or DC common.

Figure 7. PNP (sourcing) output selected

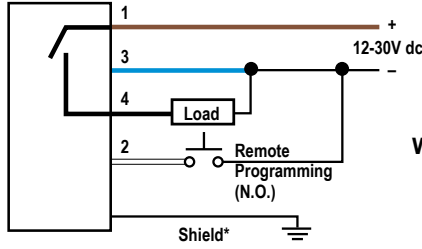

* It is recommended that the shield wire be connected to either earth ground or DC common.

Figure 8. 4-pin M12 male quick disconnect connector

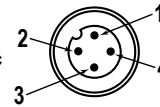

Wiring Key

- 1 = Brown
- 2 = White
- 3 = Blue
- 4 = Black

Specifications

Sensing Range

- “A” suffix models: 100 mm to 1 m (3.9 in to 39 in)
- “B” suffix models: 200 mm to 2 m (7.8 in to 78 in)
- “C” suffix models: 300 mm to 3 m (11.8 in to 118 in)

Ultrasonic Frequency

- “A” suffix models: 224 kHz
- “B” suffix models: 174 kHz
- “C” suffix models: 114 kHz

Supply Voltage

10 to 30 V DC (10% maximum ripple) at 40 mA, exclusive of load

Supply Protection Circuitry

Protected against reverse polarity and transient voltages

Output Configuration

Discrete (switched) output models: SPST solid-state switch. Configurable as NPN (sinking) or PNP (sourcing) via Mode push button. Normally Open (NO) or Normally Closed (NC) operation is also selectable via Mode push button (see [Mode Setup - Output Configuration](#) on page 2). The default setting is PNP/NO

Output Rating

Discrete output models: 100 mA max.
OFF-state leakage current: NPN: < 200 µA at 30V dc (see NOTE 1); PNP: < 10 µA at 30V dc
ON-state saturation voltage: NPN: < 1.6V at 100 mA; PNP: < 3V at 100 mA

Output Protection Circuitry

Protected against short circuit conditions

Repeatability

- “A” suffix models: 0.1% of distance (0.5 mm min.)
- “B” suffix models: 0.1% of distance (1.0 mm min.)
- “C” suffix models: 0.1% of distance (1.5 mm min.)

Sensing Hysteresis

- “A” suffix models: 2 mm
- “B” suffix models: 3 mm
- “C” suffix models: 4 mm

Minimum Window Size

10 mm (0.4 in)

Adjustments

Sensing window limits: TEACH-Mode of near and far window limits may be set using the push button or remotely via TEACH input.

Output Configuration: NPN, PNP, Normally Open (NO), Normally Closed (NC) select (see [Mode Setup - Output Configuration](#) on page 2 or [Remote Line TEACH](#) on page 6).

Advanced configuration options: Push button enabled/disabled, temperature compensation enabled/disabled (see [Remote Line TEACH](#) on page 6)

Construction

- Housing:** PBT polyester
- Push buttons:** polyester
- Transducer:** epoxy /ceramic composite

Environmental Rating

Leakproof design, rated IP67 (NEMA 6)

Connections

2 m (6.5 ft) or 9 m (30 ft) shielded 4-conductor (with drain) PVC cable, 150 mm (6 in) PUR cable with an M12 connector (QPMA), or 4-pin integral M12 connector (Q8)

Temperature Effect

0.02% of distance/°C

Delay at Power-up

500 ms

Output Response Time

- “A” suffix models: 45 ms
- “B” suffix models: 92 ms
- “C” suffix models: 135 ms

Operating Conditions

-40 °C to +70 °C (-40 °F to +158 °F)
 95% at +50 °C maximum relative humidity (non-condensing)

Vibration and Mechanical Shock

All models meet Mil. Std. 202F requirements method 201A (vibration: 10 to 60 Hz max., double amplitude 0.06 in, max acceleration 10G). Also meets IEC 947-5-2; 30G 11 ms duration, half sine wave

Certifications



Application Note

The temperature warmup drift upon power-up is less than 1% of the sensing distance.

Required Overcurrent Protection



WARNING: Electrical connections must be made by qualified personnel in accordance with local and national electrical codes and regulations.

Overcurrent protection is required to be provided by end product application per the supplied table.
 Overcurrent protection may be provided with external fusing or via Current Limiting, Class 2 Power Supply.

Supply wiring leads < 24 AWG shall not be spliced.
 For additional product support, go to www.bannerengineering.com.

Supply Wiring (AWG)	Required Overcurrent Protection (Amps)
20	5.0
22	3.0
24	2.0
26	1.0
28	0.8
30	0.5



NOTE 1: NPN < 200 µA for load impedance > 3 kΩ; for load current of 100 mA, leakage < 1% of load current

Performance Curves

With Plate Target (Typical)

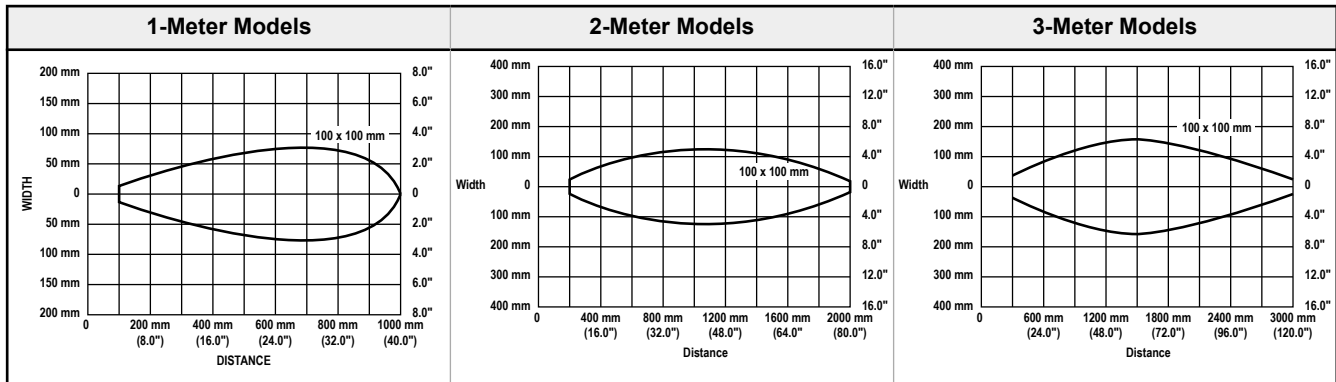

With Rod Target (Typical)

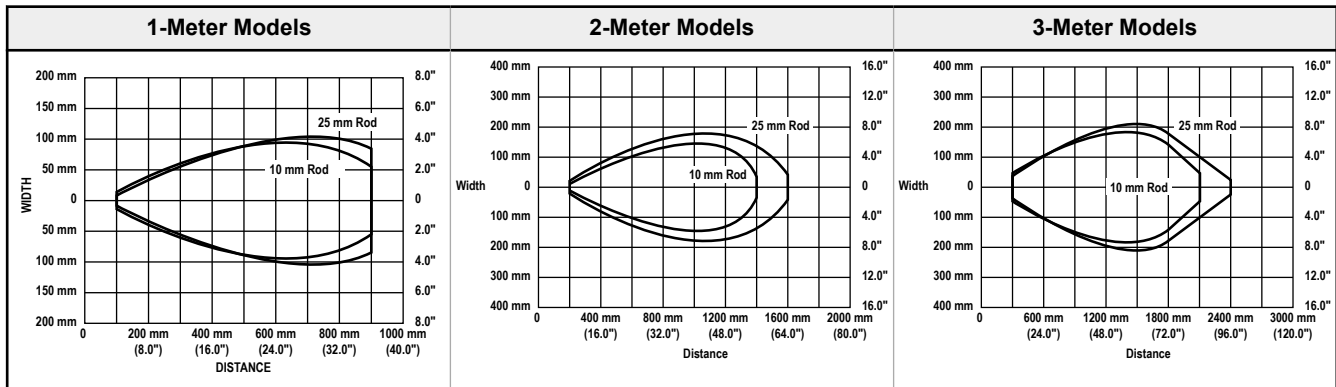

Maximum Target Rotation Angle

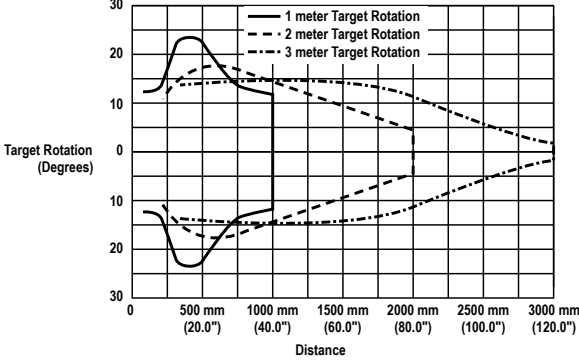

Dimensions

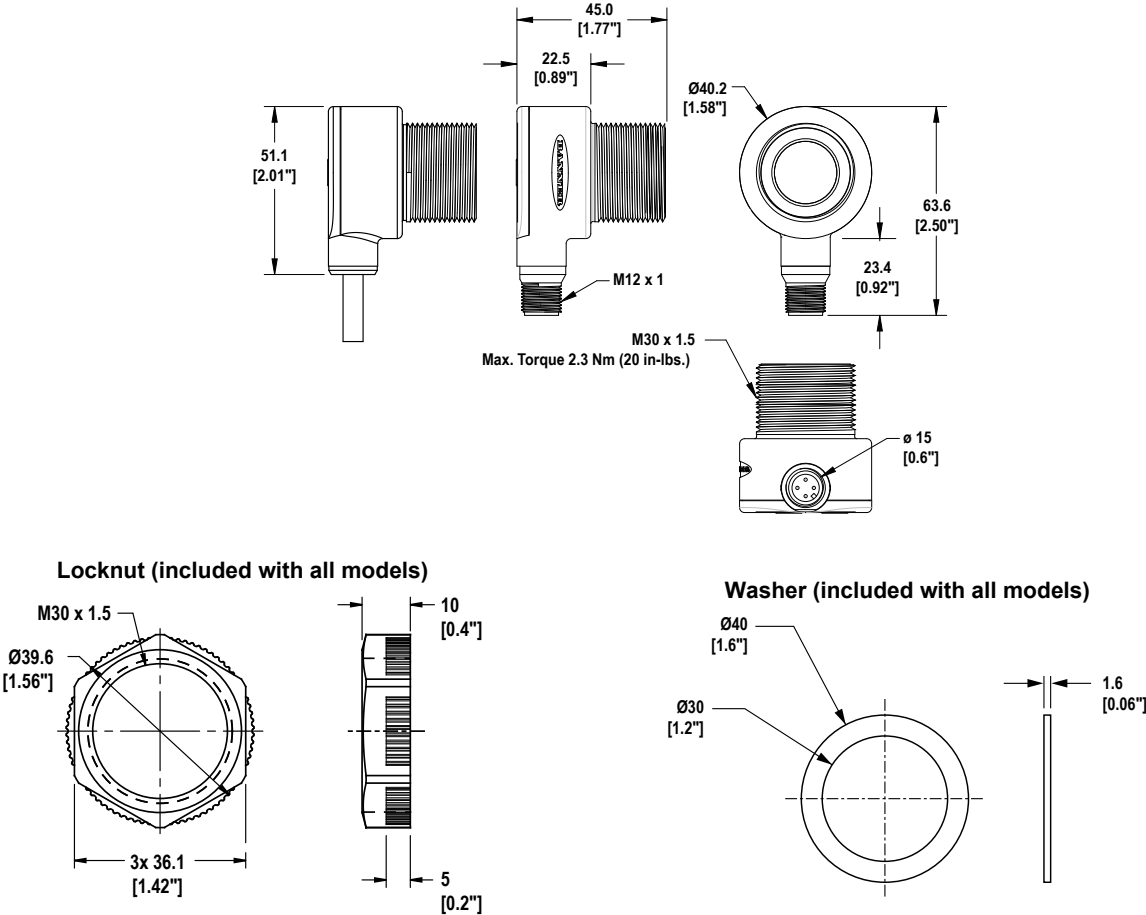

Accessories

Quick-Disconnect Cables

4-Pin Threaded M12 Cordsets with Shield—Single Ended				
Model	Length	Style	Dimensions	Pinout (Female)
MQDEC2-406	2 m (6.56 ft)	Straight		
MQDEC2-415	5 m (16.4 ft)			
MQDEC2-430	9 m (29.5 ft)			
MQDEC2-406RA	2 m (6.56 ft)	Right-Angle		
MQDEC2-415RA	5 m (16.4 ft)			
MQDEC2-430RA	9 m (29.5 ft)			

1 = Brown
2 = White
3 = Blue
4 = Black

Brackets

All measurements are in mm.

SMB30A

- Right-angle bracket with curved slot for versatile orientation
- Clearance for M6 (¼ in) hardware
- Mounting hole for 30 mm sensor
- 12-ga. stainless steel

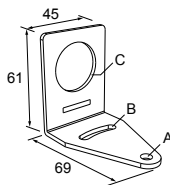

Hole center spacing: A to B=40

Hole size: A=ø 6.3, B= 27.1 x 6.3, C=ø 30.5

SMB1815SF

- Swivel with set screws for mounting sensors by the cable hub
- Black reinforced thermoplastic polyester
- Stainless steel swivel locking hardware and hex wrench included

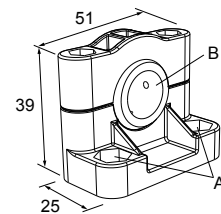

Hole center spacing: A = 36.0

Hole size: A = ø 5.0, B = ø 15.0

SMB30FA

- Swivel bracket with tilt and pan movement for precise adjustment
- Mounting hole for 30 mm sensor
- 12-ga. 304 stainless steel
- Easy sensor mounting to extrude rail T-slot
- Metric and inch size bolt available

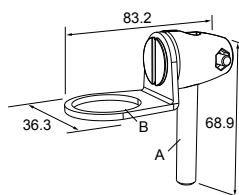

Bolt thread: SMB30FA, A= 3/8 - 16 x 2 in; SMB30FAM10, A= M10 - 1.5 x 50

Hole size: B= ø 30.1

SMB30SC

- Swivel bracket with 30 mm mounting hole for sensor
- Black reinforced thermoplastic polyester
- Stainless steel mounting and swivel locking hardware included

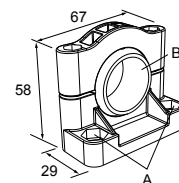

Hole center spacing: A=ø 50.8

Hole size: A=ø 7.0, B=ø 30.0

Banner Engineering Corp. Limited Warranty

Banner Engineering Corp. warrants its products to be free from defects in material and workmanship for one year following the date of shipment. Banner Engineering Corp. will repair or replace, free of charge, any product of its manufacture which, at the time it is returned to the factory, is found to have been defective during the warranty period. This warranty does not cover damage or liability for misuse, abuse, or the improper application or installation of the Banner product.

THIS LIMITED WARRANTY IS EXCLUSIVE AND IN LIEU OF ALL OTHER WARRANTIES WHETHER EXPRESS OR IMPLIED (INCLUDING, WITHOUT LIMITATION, ANY WARRANTY OF MERCHANTABILITY OR FITNESS FOR A PARTICULAR PURPOSE), AND WHETHER ARISING UNDER COURSE OF PERFORMANCE, COURSE OF DEALING OR TRADE USAGE.

This Warranty is exclusive and limited to repair or, at the discretion of Banner Engineering Corp., replacement. **IN NO EVENT SHALL BANNER ENGINEERING CORP. BE LIABLE TO BUYER OR ANY OTHER PERSON OR ENTITY FOR ANY EXTRA COSTS, EXPENSES, LOSSES, LOSS OF PROFITS, OR ANY INCIDENTAL, CONSEQUENTIAL OR SPECIAL DAMAGES RESULTING FROM ANY PRODUCT DEFECT OR FROM THE USE OR INABILITY TO USE THE PRODUCT, WHETHER ARISING IN CONTRACT OR WARRANTY, STATUTE, TORT, STRICT LIABILITY, NEGLIGENCE, OR OTHERWISE.**

Banner Engineering Corp. reserves the right to change, modify or improve the design of the product without assuming any obligations or liabilities relating to any product previously manufactured by Banner Engineering Corp. Any misuse, abuse, or improper application or installation of this product or use of the product for personal protection applications when the product is identified as not intended for such purposes will void the product warranty. Any modifications to this product without prior express approval by Banner Engineering Corp will void the product warranties. All specifications published in this document are subject to change; Banner reserves the right to modify product specifications or update documentation at any time. Specifications and product information in English supersede that which is provided in any other language. For the most recent version of any documentation, refer to:

www.bannerengineering.com.

For patent information, see www.bannerengineering.com/patents.



more sensors, more solutions