

IFRD 08N17T1/S35

Inductive sensors special versions - high temperature

Article number: 10150427

Overview

- 2 mm
- NPN make function (NO)
- connector M8
- -25 ... 100 °C
- IP 69K



Picture similar



Technical data

General data

Mounting type	Quasi-flush
Special type	Full metal housing (<kursiv>Duro-Prox</kursiv>) High temperature

Nominal sensing distance
Sn 2 mm

Hysteresis 2 ... 20 % of Sr

Electrical data

Switching frequency	150 Hz
Voltage supply range +Vs	10 ... 30 VDC
Current consumption max. (no load)	20 mA
Output circuit	NPN make function (NO)
Voltage drop Vd	< 2 VDC

Electrical data

Output current	< 100 mA
Short circuit protection	Yes
Reverse polarity protection	Yes

Mechanical data

Type	Cylindrical threaded
Material (sensing face)	Stainless steel 1.4404 (V4A)
Housing material	Stainless steel 1.4404 (V4A)
Operating pressure static	< 20 bar
Dimension	8 mm
Housing length	46 mm
Connection types	Connector M8

Ambient conditions

Operating temperature	-25 ... +100 °C
Protection class	IP 69K

Remarks

- Higher noise immunity (EMC), (EN 61000-6-2)

IFRD 08N17T1/S35

Inductive sensors special versions - high temperature

Article number: 10150427

Dimension drawing

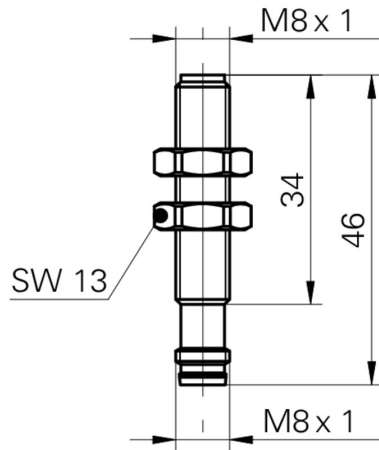

Connection diagram

