

**Overview**

- 8 mm
- PNP break function (NC)
- cable, 2 m
- -25 ... 75 °C
- IP 67



Picture similar



**Technical data**

**General data**

Mounting type	Quasi-flush
Nominal sensing distance S <sub>n</sub>	8 mm
Hysteresis	3 ... 20 % of S <sub>r</sub>
Output indicator	LED red

**Electrical data**

Switching frequency	500 Hz
Voltage supply range +V <sub>s</sub>	6 ... 36 VDC
Current consumption max. (no load)	10 mA
Output circuit	PNP break function (NC)
Voltage drop V <sub>d</sub>	< 2 VDC
Output current	< 200 mA

**Electrical data**

Short circuit protection	Yes
Reverse polarity protection	Yes

**Mechanical data**

Type	Cylindrical threaded
Material (sensing face)	PBT
Housing material	Brass nickel plated
Dimension	18 mm
Housing length	65 mm
Connection types	Cable, L=2 m
Tightening torque max.	40 Nm

**Ambient conditions**

Operating temperature	-25 ... +75 °C
Protection class	IP 67

**Remarks**

- Not for flush mounting in mild steel

# IFRM 18P37A4/L

Inductive proximity switch - standard

Article number: 11111679

## Dimension drawing

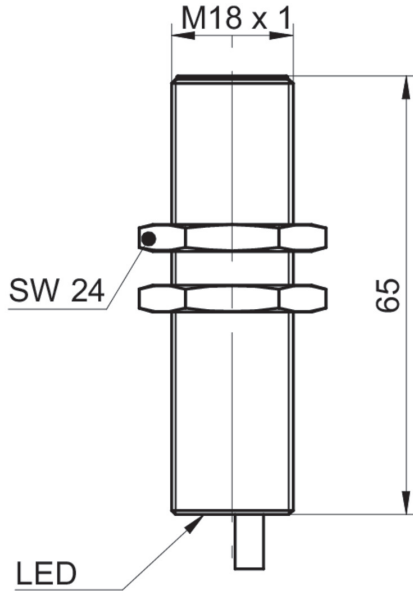

## Connection diagram

