

HMG 161

Encoder with through hollow shaft max. $\varnothing 70$ mm

Single and multiturn 13 bit ST / 12 or 16 bit MT SSI / Profibus / CANopen® / DeviceNet

Overview

- Multiturn / SSI / Profibus / CANopen® / DeviceNet
- Optical sensing method
- Singleturn 13 bit, multiturn 12 bit / 16 bit
- Through hollow shaft $\varnothing 38 \dots 70$ mm
- Multiturn sensing with microGen technologie, without gear or battery
- Special protection against corrosion

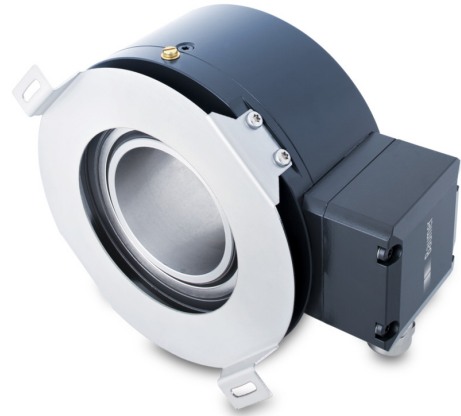

Technical data

Technical data - electrical ratings

Voltage supply	9...30 VDC
Consumption w/o load	≤100 mA (per interface SSI) ≤250 mA (per interface bus)
Initializing time	≤ 200 ms after power on
Interface	SSI Profibus-DPV0 CANopen® DeviceNet
Function	Multiturn
Transmission rate	9.6 ... 12000 kBaud (Profibus) 10 ... 1000 kBaud (CANopen®) 125 ... 500 kBaud (DeviceNet)
Profile conformity	Profibus-DPV0 CANopen® CiA DSP 406 V 3.0 Device Profile Encoder V 1.0
Device adress	Rotary switches in bus cover
Steps per revolution	8192 / 13 bit
Number of revolutions	≤65536 / 16 bit
Additional outputs	Square-wave TTL (RS422) Square-wave HTL
Sensing method	Optical
Code	Gray (version SSI)
Code sequence	CW default
Inputs	SSI clock (version SSI)
Incremental output	2048 pulses per revolution
Interference immunity	EN 61000-6-2
Emitted interference	EN 61000-6-3
Programmable parameters	Depending on the selected absolute interface

Technical data - electrical ratings

Diagnostic function	Position or parameter error
Status indicator	DUO-LED integrated in bus cover
Approval	CE UL approval / E217823

Technical data - mechanical design

Size (flange)	$\varnothing 160$ mm
Shaft type	$\varnothing 38 \dots 70$ mm (through hollow shaft)
Protection EN 60529	IP 56
Operating speed	≤3500 rpm (mechanical)
Operating torque typ.	15 Ncm
Rotor moment of inertia	28.5 kgcm ² ($\varnothing 50$)
Admitted shaft load	≤350 N axial ≤500 N radial
Material	Housing: aluminium Shaft: stainless steel
Corrosion protection	IEC 60068-2-52 Salt mist for ambient conditions C4 according to ISO 12944-2
Operating temperature	-20...+85 °C
Resistance	IEC 60068-2-6 Vibration 10 g, 10-2000 Hz IEC 60068-2-27 Shock 200 g, 6 ms
Explosion protection	II 3 G Ex ec IIC T4 Gc (gas) II 3 D Ex tc IIIB T135°C Dc (dust) (only with option ATEX)
Weight approx.	5 - 6.4 kg (depending on version)
Connection	Bus cover Connecting terminal (SSI/incremental)

Optional

- Additional incremental output (TTL / HTL)
- Insulated bearing

HMG 161

Encoder with through hollow shaft max. $\varnothing 70$ mm

Single and multitem 13 bit ST / 12 or 16 bit MT SSI / Profibus / CANopen® / DeviceNet

Terminal assignment

Profibus-DP - View A (see dimension)

View inside bus connecting box Profibus

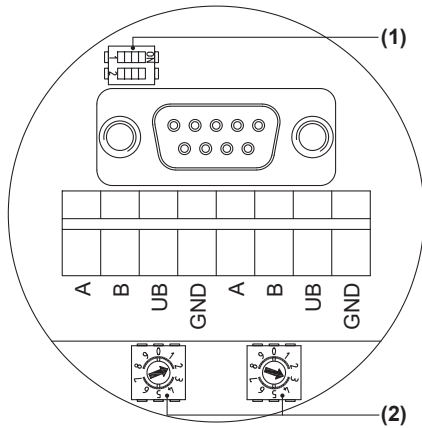

Terminals of the same significance are internally connected and identical in their functions. Max. load on the internal terminal connections UB-UB and GND-GND is 1 A each.

Profibus-DP - Terminating resistor (1)

ON = Last user

OFF = User x



Profibus-DP - User address (2)

Defined by rotary switch.

Example: User address 23

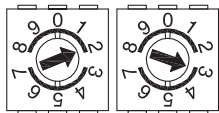

CANopen - View A (see dimension)

View inside bus connecting box CANopen®

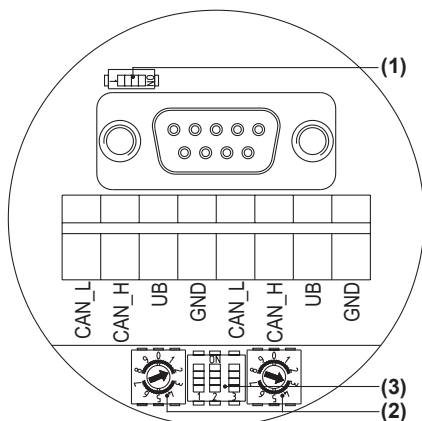

Terminals of the same significance are internally connected and identical in their functions. Max. load on the internal terminal connections UB-UB and GND-GND is 1 A each.

Terminal assignment

CANopen - Terminating resistor (1)

ON = Last user

OFF = User x



CANopen - User address (2)

Defined by rotary switch.

Example: User address 23

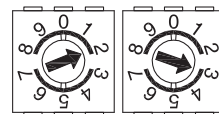

CANopen - Transmission rate (3)

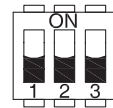

Transmission rate	Setting DIP switches		
	1	2	3
10 kBaud	OFF	OFF	OFF
20 kBaud	OFF	OFF	ON
50 kBaud*	OFF	ON	OFF
125 kBaud	OFF	ON	ON
250 kBaud	ON	OFF	OFF
500 kBaud	ON	OFF	ON
800 kBaud	ON	ON	OFF
1000 kBaud	ON	ON	ON

* Factory setting

DeviceNet - View A (see dimension)

View inside bus connecting box DeviceNet

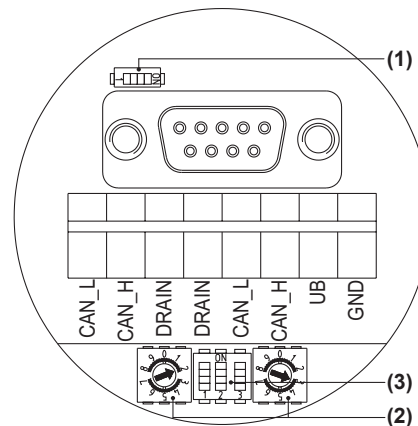

Terminals of the same significance are internally connected and identical in their functions. Max. load on the internal terminal connections UB-UB and GND-GND is 1 A each.

HMG 161

Encoder with through hollow shaft max. $\varnothing 70$ mm

Single and multitem 13 bit ST / 12 or 16 bit MT SSI / Profibus / CANopen® / DeviceNet

Terminal assignment

DeviceNet - Terminating resistor (1)

ON = Last user

OFF = User x

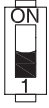

DeviceNet - User address (2)

Defined by rotary switch.

Example: User address 23

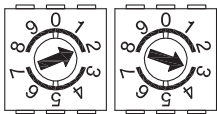

DeviceNet - Transmission rate (3)

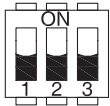

Transmission rate	Setting DIP switches		
	1	2	3
125 kBaud*	X	OFF	OFF
250 kBaud	X	OFF	ON
500 kBaud	X	ON	OFF
125 kBaud	X	ON	ON

X = Without function

* Factory setting

Incremental - View B (see dimension)

Connecting terminal terminal box

Incremental output (HTL, TTL)

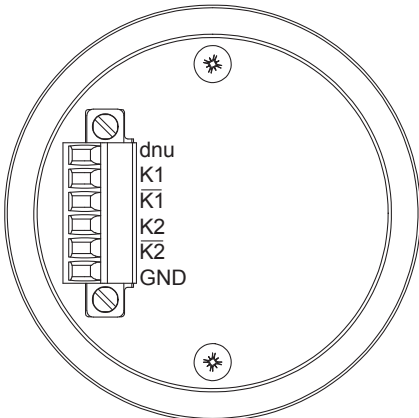

Terminal assignment

SSI - View B (see dimension)

Connecting terminal terminal box

SSI / incremental output (HTL, TTL)

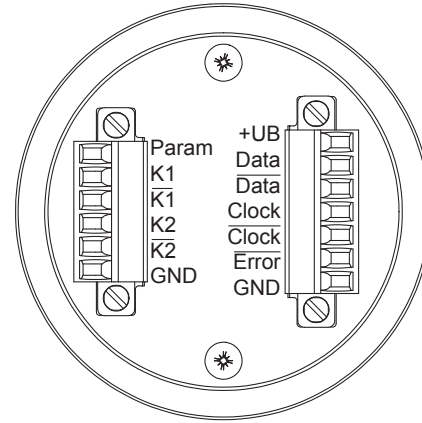

SSI - View C (see dimension)

Assignment flange connector (option)

SSI / incremental output (HTL, TTL)

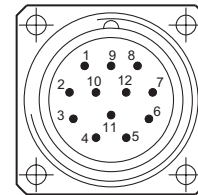

Flange connector M23, male, 12-pin, counter-clockwise (CCW)

Pin	Assignment
1	$\overline{K2}$
2	Clock*
3	Data*
4	$\overline{\text{Data}}^*$
5	K1
6	K1
7	Param*
8	K2
9	$\overline{\text{Error}}^*$
10	0V (\perp)
11	$\overline{\text{Clock}}^*$
12	+UB*

* Only for SSI

Terminal significance

Profibus

Connection	Description
GND	Ground for UB
UB	Voltage supply 10...30 VDC
A	Negative serial data transmission
B	Positive serial data transmission
dnu	Do not use

HMG 161

Encoder with through hollow shaft max. $\varnothing 70$ mm

Single and multitem 13 bit ST / 12 or 16 bit MT SSI / Profibus / CANopen® / DeviceNet

Terminal significance

CANopen®

Connection	Description
GND	Ground for UB
UB	Voltage supply 10...30 VDC
CAN_H	CAN Bus signal (dominant HIGH)
CAN_L	CAN Bus signal (dominant LOW)

DeviceNet

Connection	Description
GND	Ground for UB
UB	Voltage supply 10...30 VDC
CAN_H	CAN Bus signal (dominant HIGH)
CAN_L	CAN Bus signal (dominant LOW)
DRAIN	Shield connection

SSI / incremental output (HTL, TTL)

+UB	Voltage supply
0V (⊥, GND)	Ground
K1	Output signal channel 1
$\overline{K1}$	Output signal channel 1 inverted
K2	Output signal channel 2 (offset by 90° to channel 1)
$\overline{K2}$	Output signal channel 2 inverted
Clock	SSI clock
$\overline{\text{Clock}}$	SSI clock inverted
Data	SSI data
$\overline{\text{Data}}$	SSI data inverted
Param	Parameter
$\overline{\text{Error}}$	Error output
dnu	Do not use

Output signals incremental

HTL/TTL

At positive rotating direction (see dimension)

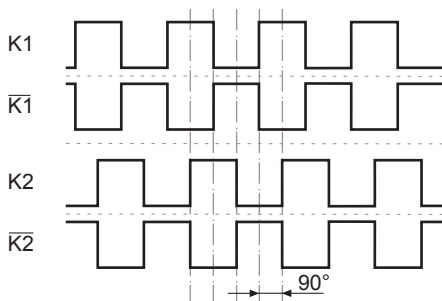

Data transfer

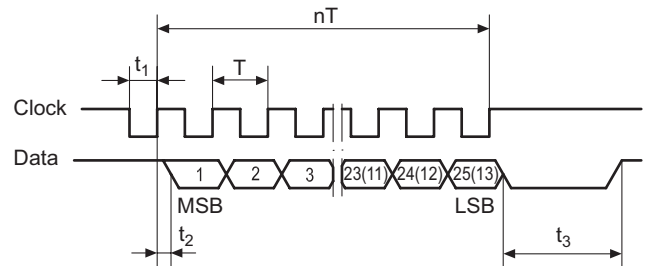

T =	1.25...10 μs
t_1 =	0.63...5 μs
t_2 =	0.4 μs
t_3 =	12...30 μs
n =	Number of bits
Clock frequency	100...800 kHz

HMG 161

Encoder with through hollow shaft max. $\varnothing 70$ mm

Single and multitem 13 bit ST / 12 or 16 bit MT SSI / Profibus / CANopen® / DeviceNet

Dimensions

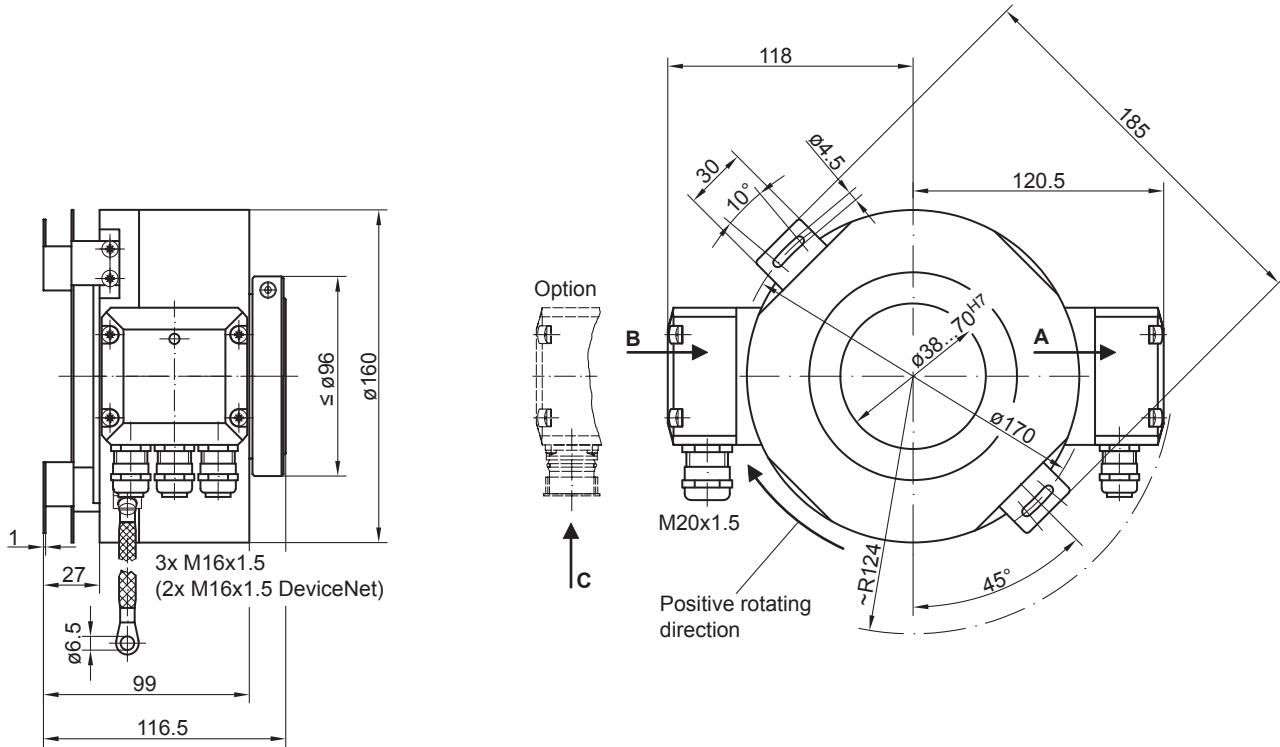

HMG 161

 Encoder with through hollow shaft max. \varnothing 70 mm

Single and multitem 13 bit ST / 12 or 16 bit MT SSI / Profibus / CANopen® / DeviceNet

Ordering reference

	HMG161	#	##	#####	#####
Product	Absolute encoder	HMG161			
Interface/interfaces					
SSI		S			
Profibus		P			
CANopen®		C			
DeviceNet		D			
Absolute share					
13 bit singleturn			13		
13 bit singleturn + 12 bit multitem ⁽¹⁾			25		
13 bit singleturn + 16 bit multitem ⁽²⁾			29		
Additional output					
Without				Z0	
TTL level, 2048 pulses				T2048	
HTL level, 2048 pulses				H2048	
Shaft diameter					
Through hollow shaft \varnothing 40 mm					40H7
Through hollow shaft \varnothing 42 mm					42H7
Through hollow shaft \varnothing 50 mm					50H7
Through hollow shaft \varnothing 55 mm					55H7
Through hollow shaft \varnothing 60 mm					60H7
Through hollow shaft \varnothing 65 mm					65H7
Through hollow shaft \varnothing 70 mm					70H7

(1) Only version S

(2) Only version P, C und D