

EAM360-K - SSI

Encoder kit

Magnetic single- or multiturn encoders 14 bit ST / 18 bit MT

Overview

- Encoder kit single- or multiturn / SSI
- Precise magnetic sensing
- Angular accuracy up to $\pm 0.15^\circ$
- Resolution max. 32 bit (14 bit ST, 18 bit MT)
- Additional incremental signals
- Clock frequency up to 2 MHz
- High protection up to IP 67
- High resistance to shock and vibrations
- Magnetic rotor included in delivery



Technical data

Technical data - electrical ratings

Voltage supply	4.5...30 VDC (SSI, SSI + TTL/RS422) 5.5...30 VDC (SSI + HTL/Push-pull)
Consumption typ.	60 mA (5 VDC, w/o load) 20 mA (24 VDC, w/o load)
Initializing time	≤ 170 ms after power on
Data currency	Typ. 2 μ s (cyclic request)
Interface	SSI SSI + incremental
Function	Multiturn Singleturn
Operating mode	Linear feedback shift register (on request)
Steps per revolution	≤ 16384 / 14 bit
Number of revolutions	≤ 262144 / 18 bit
Absolute accuracy	$\pm 0.15^\circ$ ($+20 \pm 15^\circ\text{C}$) $\pm 0.25^\circ$ ($-40...+85^\circ\text{C}$)
Sensing method	Magnetic
Code	Gray or binary
Code sequence	CW: ascending values with clockwise sense of rotation; looking at flange
Inputs	SSI clock: Linereceiver RS422 Zero setting input Counting direction
Output stages	SSI data: Linedriver RS422 Incremental: linedriver RS422 or push-pull (option)
Incremental output	1024, 2048, 4096 ppr (other on request)

Technical data - electrical ratings

Output signals	A+, A-, B+, B-
Output frequency	≤ 350 kHz
Interference immunity	EN 61000-6-2
Emitted interference	EN 61000-6-4
Diagnostic function	DATAVALID (on request)
Approval	UL approval / E217823

Technical data - mechanical design

Size (flange)	$\varnothing 36$ mm
Shaft type	$\varnothing 6$ mm (magnet bore) $\varnothing 8$ mm (magnet bore) $\varnothing 12$ mm (magnet bore)
Protection EN 60529	IP 67
Operating speed	≤ 6000 rpm
Working distance	1.1 ± 0.9 mm axial / ≤ 0.3 mm eccentricity
Material	Housing: steel zinc-coated Flange: aluminium
Operating temperature	$-40...+85^\circ\text{C}$ (see general information)
Relative humidity	95 %
Resistance	EN 60068-2-6 Vibration 30 g, 10-2000 Hz EN 60068-2-27 Shock 500 g, 1 ms
Weight approx.	170 g
Connection	Flange connector M12, 8-pin Flange connector M12, 12-pin Cable 2 m

Optional

- Protection against corrosion CX (C5-M)

EAM360-K - SSI

Encoder kit

Magnetic single- or multitem encoders 14 bit ST / 18 bit MT

General information

Self-heating correlated to installation and ambient conditions as well as to electronics and supply voltage must be considered for precise thermal dimensioning. Operating the encoder close to the maximum limits requires measuring the real prevailing temperature at the encoder flange.

Terminal assignment

Cable / Flange connector M12, 8-pin for connection reference -L and -B

Pin	Core color	Signals	Description
1	white	0 V	Supply voltage
2	brown	+Vs	Supply voltage
3	green	Clock+	Clock signal
4	yellow	Clock-	Clock signal
5	grey	Data+	Data signal
6	pink	Data-	Data signal
7	blue	SET	Zero setting input
8	red	DIR	Counting direction input*

Screen connected to housing

Cable data: 4 x 2 x 0.14 mm², twisted in pairs

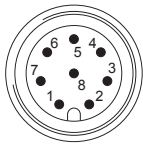

Male, A-coded

Cable / Flange connector M12, 12-pin for connection reference -L and -K

Pin	Core color	Signals	Description
1	brown	+Vs	Supply voltage
2	blue	SET	Zero setting input
3	white	0 V	Supply voltage
4	green	Clock+	Clock signal
5	pink	Data-	Data signal
6	yellow	Clock-	Clock signal
7	black	A+	Incremental signal
8	grey	Data+	Data signal
9	red	DIR	Counting direction input*
10	violet	A-	Incremental signal
11	grey/pink	B+	Incremental signal
12	red/blue	B-	Incremental signal

Screen connected to housing

Cable data: 6 x 2 x 0.14 mm², twisted in pairs

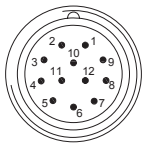

Male, A-coded

* Not applicable by option: DATAVALID

Terminal significance

SET	Zero setting. Input for zero setting at any position. The zero setting operation is triggered by a high pulse and has to be in line with the selected direction of rotation (DIR). Impulse duration >100 ms. Connect to 0 V after zero setting for maximum interference immunity.
DIR	Counting direction input. The input is standard on high. For maximum interference immunity connect to +Vs respectively 0 V depending on counting direction. CW HIGH - CCW LOW (Version with DATAVALID does not include the counting direction input).

Output signals

Incremental signals: clockwise rotating direction when looking at flange.

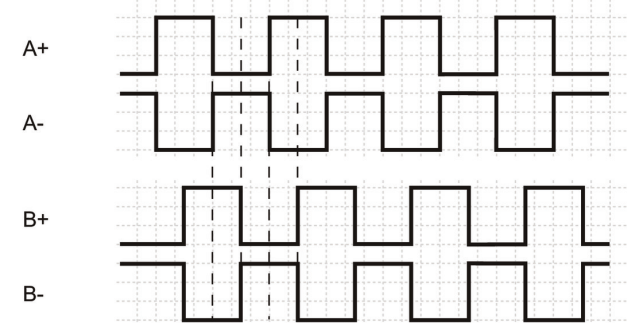

Trigger level

Control inputs	Input circuit
Maximal	0...+Vs
Input level Low	<1 V
Input level High	>2.1 V

RS422

Output level High	>2.3 V
Output level Low	<0.5 V
Load	<20 mA

Push-pull

Output level High	≥+VS -2.2 V
Output level Low	<0.7 V
Load	<20 mA

Applies to standard cable lengths up to 2 m, for longer cables the voltage drop must be taken into account.

Data transfer

Output signal

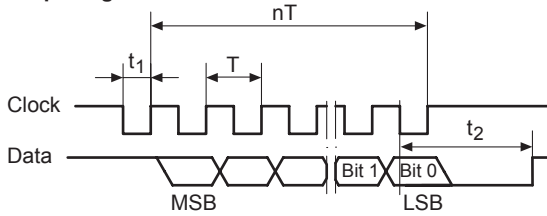

$T = 0.5 \dots 10 \mu\text{s}$	$t_1 = 0.25 \dots 5 \mu\text{s}$
$t_2 = 20 \pm 2 \mu\text{s}$	$f \text{ max.} = 2 \text{ MHz}$

Data acquisition time t_a

Following timing of the SSI Masters is the requirement for a data refresh rate of typ. 2 μs . If this is not fulfilled the data refresh rate is <50 μs .

$t_a < 5000 \mu\text{s}$

$t_a \text{ jitter} < \pm 2 \mu\text{s}$

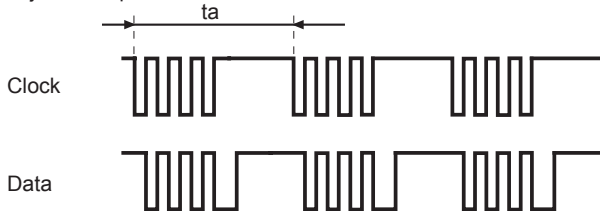

Working distance

The ideal working distance of the magnet related to the encoder is at an eccentricity of 0 mm and an axial distance of 1.1 mm. Deviation affects the accuracy as shown in following diagram.

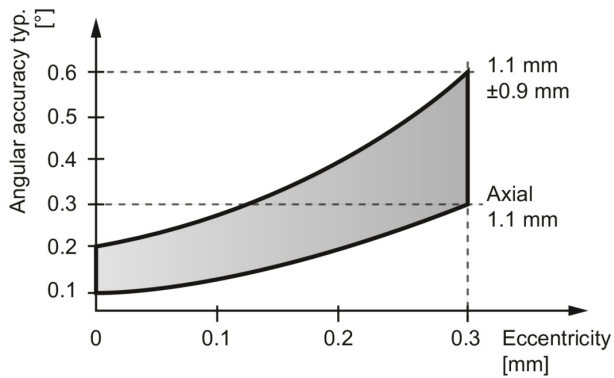

EAM360-K - SSI

Encoder kit

Magnetic single- or multiturn encoders 14 bit ST / 18 bit MT

Dimensions

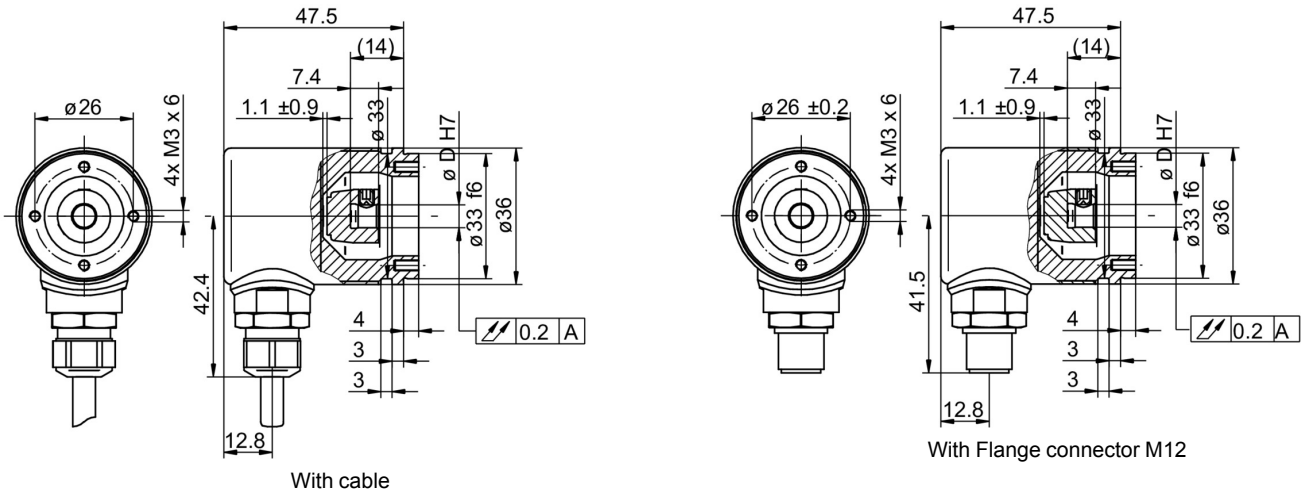

EAM360-K - SSI

Encoder kit

Magnetic single- or multiturn encoders 14 bit ST / 18 bit MT

Ordering reference

	EAM360	-	K	W	##	.	7	#	##	.	##	##	#	.	A
Product	EAM360														
Shaft type	Kit		K												
Flange (kit)	Synchro flange, ø33 mm, M3			W											
Magnet holder / bore diameter	ø6 mm				6										
	ø8 mm				8										
	ø12 mm				C										
Protection class	IP 67						7								
Connection	Flange socket radial, M12, 8-pin, male contacts, CCW								B						
	Flange socket radial, M12, 12-pin, male contacts, CCW								K						
	Cable radial, 2 m								L						
Voltage supply / interface	4.5...30 VDC, SSI binary										4B				
	4.5...30 VDC, SSI gray										4G				
Resolution Singleturn	10 Bit												10		
	12 Bit												12		
	13 Bit												13		
	14 Bit												14		
Resolution Multiturn	No option													00	
	12 Bit													12	
	13 Bit													13	
	16 Bit													16	
	18 Bit													18	
Resolution supplement	No option														0
	4096 ppr TTL (RS422), 4 channels														H
	2048 ppr TTL (RS422), 4 channels														8
	1024 ppr TTL (RS422), 4 channels														5
Operating temperature	-40...+85 °C														

Accessories

Mounting accessories

10106004 Clamp set ø10 mm