

Overview

- Best measuring performance due to precise measuring principle
- Parallel output signal to the IO-Link channel through Dual Channel
- Flexible parameterization and additional diagnostic data thanks to IO-Link
- Shortest blind zone in its class
- High performance in compact housing



Picture similar



Technical data

General data

Scanning range Sd	15 ... 500 mm
Scanning range close limit Sdc	15 ... 500 mm
Scanning range far limit Sde	15 ... 500 mm
Version	IO-Link dual channel
Hysteresis typ.	4 % Sde
Repeat accuracy	0.5 mm
Resolution	< 0.3 mm
Response time ton/toff standard	< 40 ms
Response time ton/toff min	< 16 ms
Temperature drift	< 2 % of distance to target Sde
Power-up drift	Compensated after 15 min.
Sonic frequency	290 kHz
Adjustment	qTeach, IO-Link
Light indicator	LED yellow
Power on indication	LED green
Alignment measuring axis	< 2°

Electrical data

Voltage supply range +Vs	12 ... 30 VDC
Current consumption typ.	13 mA
Output circuit	Current output
Output signal	4 ... 20 mA / 20 ... 4 mA
Load resistance	< (+Vs - 10V) / 0,02 A
Residual ripple	< 10 % Vs
Short circuit protection	Yes
Reverse polarity protection	Yes, Vs to GND

Communication interface

Interface	IO-Link V1.1
-----------	--------------

Communication interface

Baud rate	38,4 kBaud (COM 2)
Cycle time	≥ 8 ms
Process data length	48 Bit
Process data structure	Bit 0 = SSC1 (distance) Bit 1 = SSC2 (distance) Bit 2 = quality Bit 3 = alarm Bit 5 = SSC4 (counter) Bit 8-15 = scale factor Bit 16-47 = 32 Bit measurement
IO-Link port type	Class A
Additional data	Distance Excess gain Operating cycles Operating hours Boot cycles Operating voltage Device temperature Histograms
Adjustable parameters	Switching point Switching hysteresis Measured value filtering Time filters LED status indicators Output logic Output circuit Counter Beam forming Analog output characteristic Deactivate the sensor element Find Me function

Mechanical data

Design	Rectangular
Housing material	Plastic (ASA, PMMA)

Technical data

Mechanical data

Width / diameter	20.5 mm
Height / length	41 mm
Depth	15 mm
Connection types	Cable 4 pin, 2 m

Ambient conditions

Operating temperature	-25 ... +65 °C
Storage temperature	-25 ... +75 °C
Protection class	IP 67

Dimension drawing

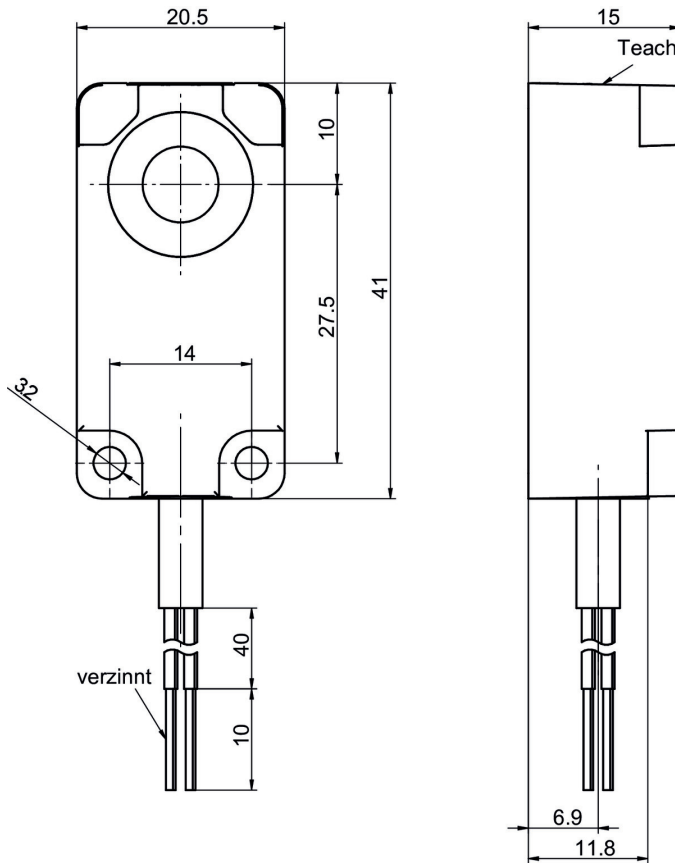

Typical sonic cone profile

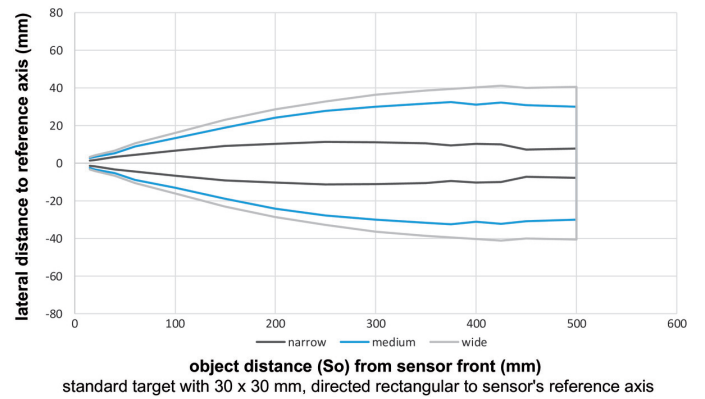

Connection diagram

