

**Overview**

- Most reliable object detection through barrier principle
- Flexible parameterization and additional diagnostic data thanks to IO-Link
- High performance in compact housing



Picture similar



**Technical data**

**General data**

Scanning range Sd	0 ... 500 mm
Reflector position Sde	15 ... 500 mm
Adjusting range reflector (operating range)	± 2,5 % Sde
Adjusting range reflector (limit range)	± 5 % Sde
Version	IO-Link
Repeat accuracy	0.5 mm
Response time ton/toff min	< 16 ms
Response time ton/toff standard	< 40 ms
Temperature drift	< 2 % of distance to target Sde
Power-up drift	Compensated after 15 min.
Sonic frequency	290 kHz
Adjustment	qTeach, line-Teach, IO-Link
Alignment aid	Light indicator flashing
Light indicator	LED yellow
Power on indication	LED green
Alignment measuring axis	< 2°

**Electrical data**

Voltage supply range +Vs	12 ... 30 VDC
Current consumption typ.	12 mA
Output circuit	Push-pull
Output current	<100 mA
Voltage drop Vd	<3 VDC
Residual ripple	< 10 % Vs
Short circuit protection	Yes
Reverse polarity protection	Yes, Vs to GND

**Communication interface**

Interface	IO-Link V1.1
-----------	--------------

**Communication interface**

Baud rate	38,4 kBaud (COM 2)
Cycle time	≥ 8 ms
Process data length	48 Bit
Process data structure	Bit 0 = SSC1 (distance) Bit 1 = SSC2 (distance) Bit 2 = quality Bit 3 = alarm Bit 5 = SSC4 (counter) Bit 8-15 = scale factor Bit 16-47 = 32 Bit measurement
IO-Link port type	Class A
Additional data	Distance Excess gain Operating cycles Operating hours Boot cycles Operating voltage Device temperature Histograms
Adjustable parameters	Switching point Switching hysteresis Measured value filtering Time filters LED status indicators Output logic Output circuit Counter Beam forming Analog output characteristic Deactivate the sensor element Find Me function

**Mechanical data**

Design	Rectangular
Housing material	Plastic (ASA, PMMA)

**Technical data**

**Mechanical data**

Width / diameter	20.5 mm
Height / length	41 mm
Depth	15 mm
Connection types	Cable 4 pin, 2 m

**Ambient conditions**

Operating temperature	-25 ... +65 °C
Storage temperature	-25 ... +75 °C
Protection class	IP 67

**Dimension drawing**

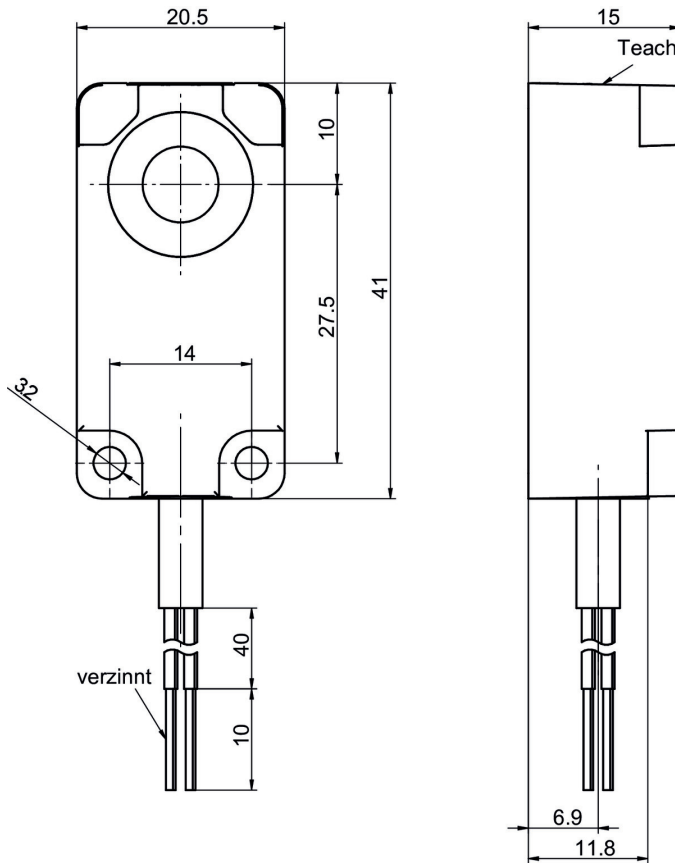

**Typical sonic cone profile**

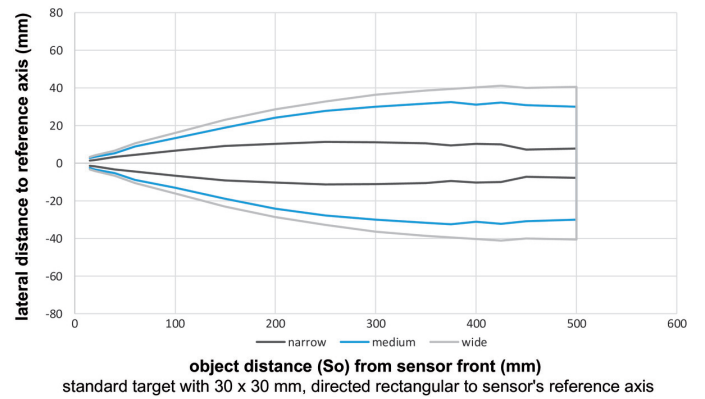

**Connection diagram**

