

Overview

- Most reliable object detection through barrier principle
- Acquisition of two independent limit values
- Detection of double sheets
- High performance in compact housing
- Metal connector



Picture similar



Technical data

General data

Emitter / receiver	Emitter
Scanning range Sd	0 ... 1000 mm
Sonic frequency	310 kHz
Power on indication	LED green

Electrical data

Voltage supply range +Vs	12 ... 30 VDC
Current consumption typ.	12 mA
Residual ripple	< 10 % Vs
Short circuit protection	Yes
Reverse polarity protection	Yes, Vs to GND

Mechanical data

Design	Rectangular
Housing material	Plastic (ASA, PMMA)
Width / diameter	20.5 mm
Height / length	41 mm
Depth	15 mm
Connection types	Connector M8 4 pin

Ambient conditions

Operating temperature	-25 ... +65 °C
Storage temperature	-25 ... +75 °C
Protection class	IP 67

Dimension drawing

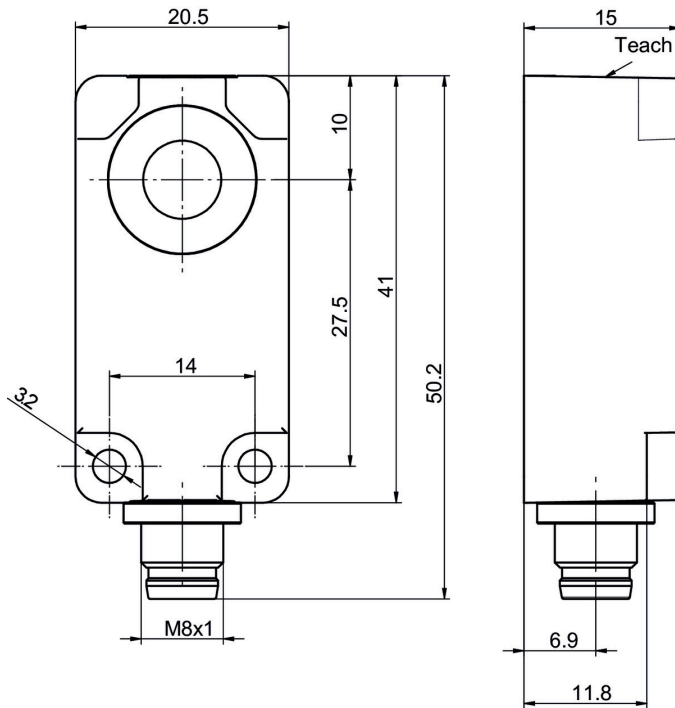

Connection diagram

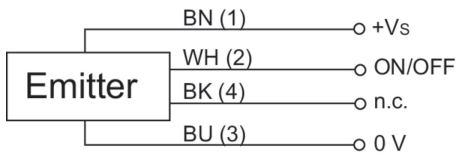

Pin assignment

