

KRTW 55

White light contrast scanner

en 05-2017/11 50112062-02



13mm



- White light transmitter
- Various teach variants
- Short response time
- Switching threshold adjustment via EasyTune
- Level adaptation for glossy objects
- 316L stainless steel housing in WASH-DOWN-Design
- Enclosed optics design prevents bacterial carry-overs
- ECOLAB and CleanProof+ tested
- Paperless device identification
- Scratch resistant and non-diffusive plastic front cover
- Keyboard lockout
- Remote teach via cable
- Pulse stretching 20ms

We reserve the right to make changes • PAL_KRTW55_en_50112062_02.fm

Accessories:

(available separately)

- Mounting systems (BT 3...)
- Cables with M8 or M12 connector (KD ...)

Dimensioned drawing

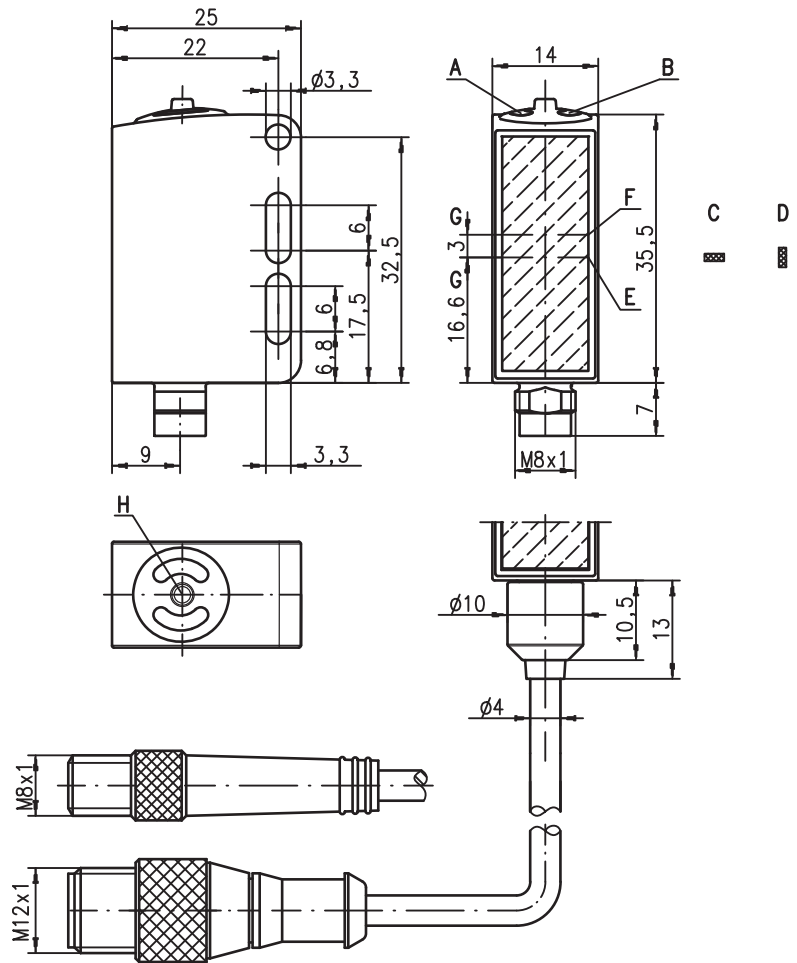

- A** Green indicator diode
- B** Yellow indicator diode
- C** Light spot orientation horizontal
- D** Light spot orientation vertical
- E** Transmitter
- F** Receiver
- G** Optical axis
- H** Teach button

Electrical connection

Connector, 4-pin

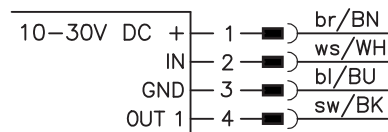

Specifications

Optical data

Scanning range ¹⁾	13mm ± 2mm
Light spot dimensions	1.5mm x 4mm (at a distance of 13mm)
Light spot orientation	vertical or horizontal (see dimensioned drawing)
Light source ²⁾	white LED (optimized through YellowBoost)
Wavelength	430 ... 700nm

Sensor operating modes

IO-Link	COM2 (38.4kbaud)
SIO	standard push-pull
Dual Core	no

Timing of the sensor

Internal switching frequency	10kHz
Internal response time	50µs
Response jitter, internal	20µs
Repeatability ³⁾	0.02mm
Delay before start-up	≤ 300ms
Conveyor speed during teach	≤ 0.1 m/s for a mark width of 1mm
Teach process	static 1-point, static 2-point or dynamic 2-point
Teach delay	≤ 10ms

Timing of the outputs

Response time	pin 4	IO-Link COM2: acc. to IO-Link specification (typically 2.5ms)
		SIO: 50µs

Electrical data

Operating voltage U_B ⁴⁾	with SIO	10 ... 30VDC (incl. residual ripple)
	with COM2	18 ... 30VDC (incl. residual ripple)
Residual ripple		≤ 15% of U_B
Output/function	.../2...	pin 4: GND if mark detected
	.../4...	pin 4: U_B if mark detected
	.../6...	pin 4: IO-Link SIO mode, U_B if mark detected
	.../6...	pin 4: IO-Link COM2 mode, see configuration file IODD
Signal voltage high/low		≥ ($U_B - 2V$) / ≤ 2V
Output current		max. 100mA
Open-circuit current		≤ 20mA

Indicators

Green LED in continuous light	ready
Green and yellow LED flashing at 3Hz	teach event active
Green and yellow LED flashing at 8Hz	teaching error
Green LED off and yellow LED flashing at 8Hz	sensor error
Yellow LED in continuous light	mark detected (dependent on the teach sequence)
Transmitter LED, white flashing at 8Hz	teaching error

Mechanical data

Housing	AISI 316L stainless steel, DIN X2CrNiMo17132, W.No1.4404
Housing design	WASH-DOWN-Design
Housing roughness ⁵⁾	$R_a \leq 2.5$
Connector	AISI 316L stainless steel, DIN X2CrNiMo17132, W.No1.4404
Optics cover	coated plastic (PMMA), scratch resistant and non-diffusive
Operation	plastic (TPV-PE), non-diffusive
Weight	with M8 connector: 40g
	with 200mm cable and M12 connector: 60g
	with 5000mm cable: 110g
Connection type	M8 connector, 4-pin, 0.2m cable with M12 connector, 4-pin 5m cable, 4 x 0.20mm ²

Environmental data

Ambient temp. (operation/storage) ⁶⁾	-30°C ... +70°C / -30°C ... +70°C
Protective circuit ⁷⁾	2, 3
VDE safety class ⁸⁾	III
Protection class ⁹⁾	IP 67, IP 69K
Environmentally tested acc. to	ECOLAB, CleanProof+
Light source	exempt group (in acc. with EN 62471)
Standards applied	IEC 60947-5-2
Certifications	UL 508, C22.2 No.14-13 ⁴⁾ ⁶⁾ ¹⁰⁾
Chemical resistance	tested in accordance with ECOLAB and CleanProof+ (see Remarks)

Options

Input pin 2	
Function characteristics	keyboard lockout / line teach / pulse stretching
Input active/not active	≥ 8V / ≤ 2V or not connected
Output pin 4	
Line teach active	for SIO 2Hz at the switching output
	for COM2 see configuration file IODD
Error after line teach	for SIO 2Hz at the switching output
	for COM2 see configuration file IODD

- 1) Scanning range: recommended range with performance reserve
- 2) Average life expectancy 100,000h at an ambient temperature of 25°C
- 3) At conveyor speed 1m/s
- 4) For UL applications: for use in class 2 circuits according to NEC only
- 5) Typical value for the stainless steel housing
- 6) UL certified in the temperature range -30°C to 55°C, operating temperatures of +70°C permissible only briefly (≤ 15min)
- 7) 2=polarity reversal protection, 3=short circuit protection for all transistor outputs
- 8) Rating voltage 50V
- 9) IP 69K only in combination with M12 connector
- 10) These proximity switches shall be used with UL Listed Cable assemblies rated 30V, 0.24A min, in the field installation

Remarks

UL REQUIREMENTS

Enclosure Type Rating: Type 1
For Use in NFPA 79 Applications only.
 Adapters providing field wiring means are available from the manufacturer. Refer to manufacturers information.

CAUTION – the use of controls or adjustments or performance of procedures other than those specified herein may result in hazardous radiation exposure.

ATTENTION ! Si d'autres dispositifs d'alignement que ceux préconisés ici sont utilisés ou s'il est procédé autrement qu'indiqué, cela peut entraîner une exposition à des rayonnements et un danger pour les personnes.

Operate in accordance with intended use!

- ⚠ This product is not a safety sensor and is not intended as personnel protection.
- ⚠ The product may only be put into operation by competent persons.
- ⚠ Only use the product in accordance with the intended use.

- With glossy objects, the sensor is to be fastened at an inclination of approx. 10° relative to the object surface.

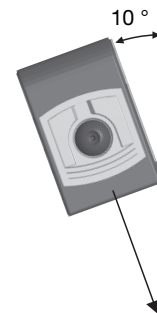

- For applications in wet environment, the customer must protect the M8-connection against humidity.

KRTW 55
White light contrast scanner
Order guide

Selection table		Order code →					
Equipment ↓		KRTW 55/6,1121-S8 Part no. 50111641	KRTW 55/4,1121-S8 Part no. 50111642	KRTW 55/4,1121,200-S12 Part no. 50110602	KRTW 55/2,1121-S8 Part no. 50110601	KRTW 55/2,1121,200-S12 Part no. 50110603	KRTW 55/4,1121,5000 Part no. 50114075
Transmitter color	white light	●	●	●	●	●	●
	RGB (red, green, blue)						
	laser-generated red light						
Light spot orientation	vertical	●	●	●	●	●	●
	horizontal						
	round						
Output (OUT 1)	PNP transistor output		●	●			●
	NPN transistor output				●	●	
	push-pull switching output	●					
	IO-Link COM2	●					
Input (IN)	teach input	●	●	●	●	●	●
Connection	M8 connector, metal	4-pin	●	●	●	●	
	200mm cable with M12 connector	4-pin			●	●	
	cable 5000mm, 4-wire						●
Teach process	static 1-point						
	static 2-point	●	●	●	●	●	●
	dynamic 2-point						
Response time / Switching frequency	50µs / 10kHz	●	●	●	●	●	●
	83µs / 6kHz						
	125µs / 4kHz						
Configuration	switching threshold adjustment with EasyTune via teach button	●	●	●	●	●	●
	remote teach, keyboard lockout and pulse stretching via pin 2	●	●	●	●	●	●
	teach level 1, teach-level 2 and pulse stretching via teach button	●	●	●	●	●	●

IO-Link process data

The sensor transmits 2 bytes to the master.

Data bit																Assignment	Default settings
15	14	13	12	11	10	9	8	7	6	5	4	3	2	1	0		
																Switching output	0 = no mark, 1 = mark detected
																Not assigned	Free
																Sensor operation	0 = off, 1 = on
																Switching threshold LSB	Value range 0 ... 31 (0 ... 100% in approx. 3% steps) 0% = min. switching threshold 100% = max. switching threshold
																Switching threshold	
																Switching threshold	
																Switching threshold MSB	
																Active transmitter LSB	00 = red, 01 = green or white,
																Active transmitter MSB	10 = blue, 11 = all colors on (teach-in active)
																Not assigned	Free
																Measurement value LSB	Value range 0 ... 31 (0 ... 100% in approx. 3% steps) 0% = min. signal level 100% = max. signal level
																Measurement value	
																Measurement value	
																Measurement value MSB	





Additional information on the IO-Link service data is available on request.



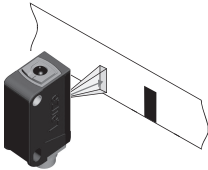
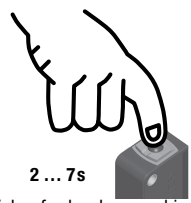
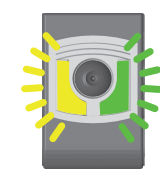
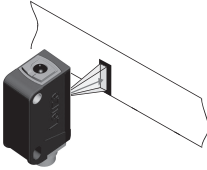
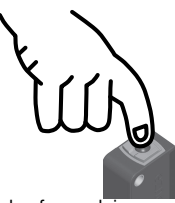

Static 2-point teach

Suitable for manual positioning of the marks (availability dependent on sensor type).

Switching threshold in center:

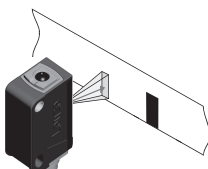
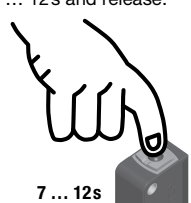
<p>Position the background.</p> 	<p>Press teach button for 2 ... 7s and release.</p>  <p>2 ... 7s Value for background is accepted.</p>	<p>LEDs flash simultaneously.</p>  <p>Simultaneous flashing</p>	<p>Position the mark.</p> 	<p>Briefly press teach button.</p>  <p>Value for mark is accepted.</p>	<p>Sensor in RUN mode. Yellow LED illuminates.</p>  <p>Switching threshold set in the center.</p>
---	--	---	---	---	--

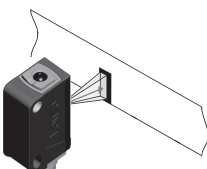
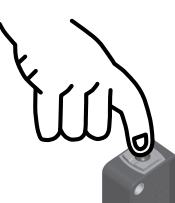
Switching threshold near the mark:

<p>Position the background.</p> 	<p>Press teach button for 7 ... 12s and release.</p>  <p>7 ... 12s Value for background is accepted.</p>	<p>LEDs flash alternately.</p>  <p>Alternating flashing</p>	<p>Position the mark.</p> 	<p>Briefly press teach button.</p>  <p>Value for mark is accepted.</p>	<p>Sensor in RUN mode. Yellow LED illuminates.</p>  <p>Switching threshold is set near the mark.</p>
---	--	---	---	---	---





KRTW 55

White light contrast scanner



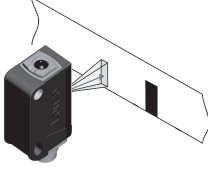
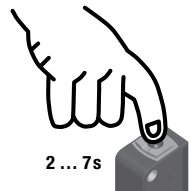

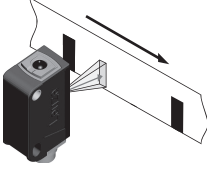
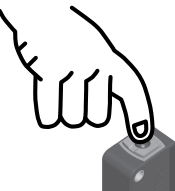
Dynamic 2-point teach

Suitable for marks moved during automated machine processes (availability dependent on sensor type).

Switching threshold in center

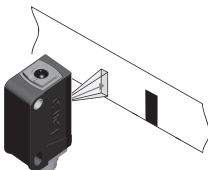
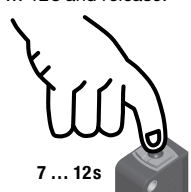
<p>Position the background.</p> 	<p>Press teach button for 2 ... 7s and release.</p> <p>2 ... 7s</p>  <p>Measurement window opens.</p>	<p>LEDs flash simultaneously.</p>  <p>Simultaneous flashing</p>	<p>Allow marks to pass through dynamically.</p> 	<p>Briefly press teach button.</p>  <p>Measurement window closes.</p>	<p>Sensor in RUN mode. Yellow LED is off.</p>  <p>Switching threshold set in the center.</p>
---	--	---	---	--	---

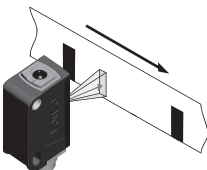
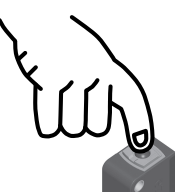

Switching threshold near the mark

<p>Position the background.</p> 	<p>Press teach button for 7 ... 12s and release.</p> <p>7 ... 12s</p>  <p>Measurement window opens.</p>	<p>LEDs flash alternatingly.</p>  <p>Alternating flashing</p>	<p>Allow marks to pass through dynamically.</p> 	<p>Briefly press teach button.</p>  <p>Measurement window closes.</p>	<p>Sensor in RUN mode. Yellow LED is off.</p>  <p>Switching threshold is set near the mark.</p>
---	--	---	---	--	--



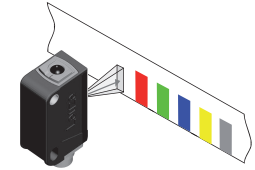
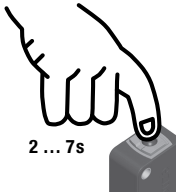
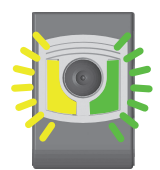
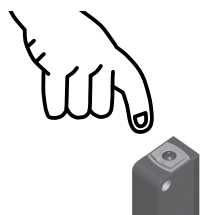

Static 1-point teach

Suitable for detecting all marks outside of the reference value (availability dependent on sensor type).

Standard sensitivity

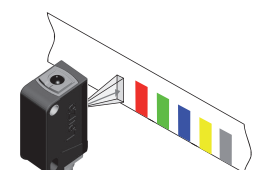
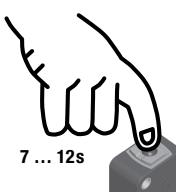
<p>Position the reference value.</p> 	<p>Press teach button for 2 ... 7s.</p> <p>2 ... 7s</p> 	<p>LEDs flash simultaneously.</p>  <p>Simultaneous flashing</p>	<p>Release teach button.</p>  <p>Value is accepted.</p>	<p>Sensor in RUN mode. Yellow LED is off.</p>  <p>Standard sensitivity is set.</p>
--	---	---	---	---

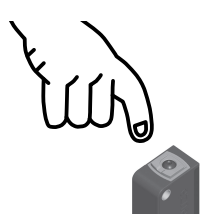
High sensitivity

<p>Position the reference value.</p> 	<p>Press teach button for 7 ... 12s.</p> <p>7 ... 12s</p> 	<p>LEDs flash alternatingly.</p>  <p>Alternating flashing</p>	<p>Release teach button.</p>  <p>Value is accepted.</p>	<p>Sensor in RUN mode. Yellow LED is off.</p>  <p>High sensitivity is set.</p>
--	---	---	---	---

Switching threshold diagrams

Static 2-point teach

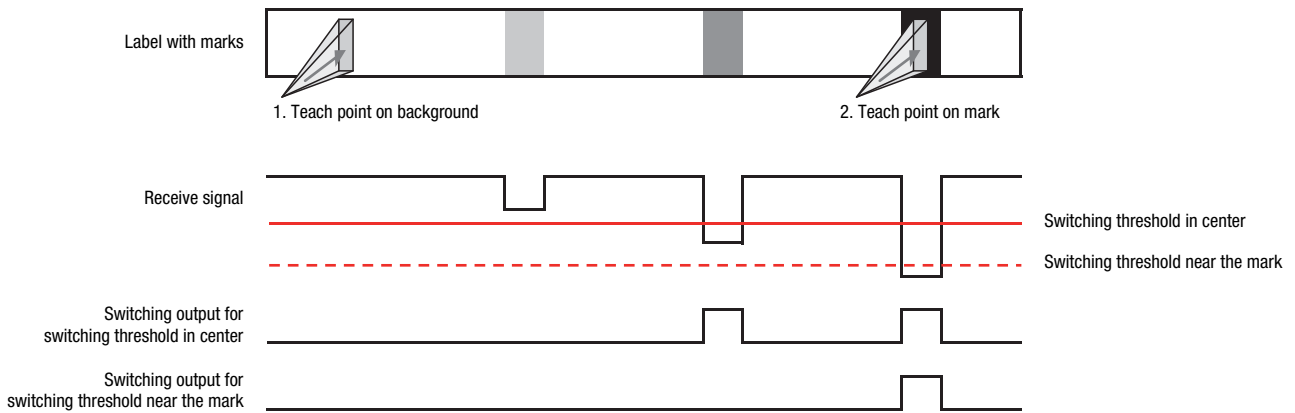

Dynamic 2-point teach

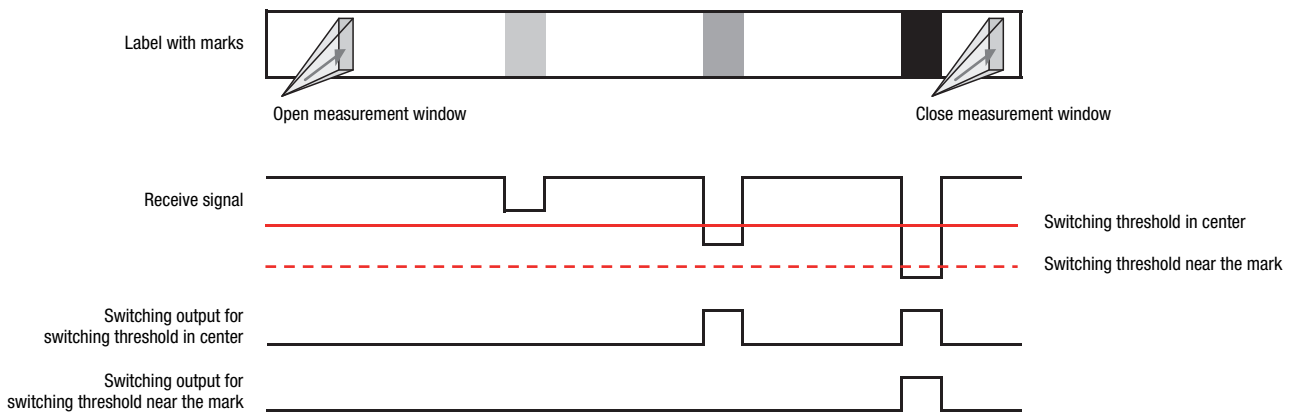

Static 1-point teach

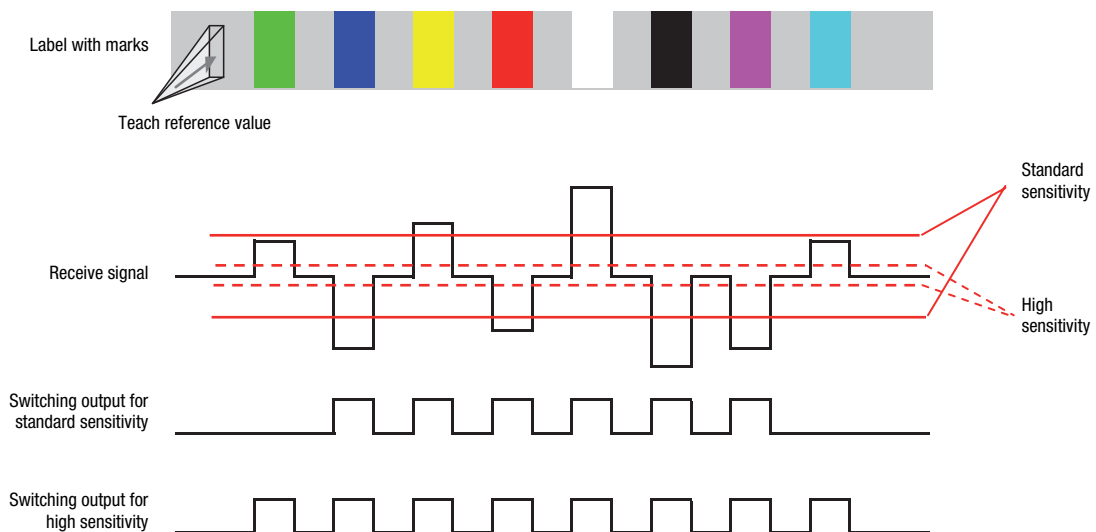

KRTW 55

White light contrast scanner

Pulse stretching option

Switching pulse stretching on or off:

Press the teach button longer than 12s.

Only the green LED flashes.

Release teach button.

Change is displayed and accepted automatically after 2s. Sensor in RUN mode.

After 2s the yellow LED is back to normal operation, displaying the state of the switching output.

After releasing the teach button, the yellow LED displays the new pulse stretching status for 2s:
 yellow LED on: pulse stretching ON
 yellow LED off: pulse stretching OFF

"EasyTune" option - fine tuning of the switching threshold

Following power-on and completed teach event:

Green LED illuminates continuously (ready)

Yellow LED on/off continuously (mark detected/not detected)

Increasing the switching threshold:

Long press of the button = large force expenditure = increase switching threshold
 Each press of the button with a duration between 200ms and 2s increments the switching threshold.

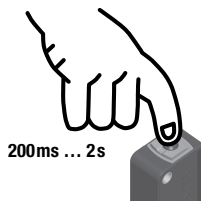

A press of the button is acknowledged by a single, brief flash of the green LED – the new switching threshold is now valid.

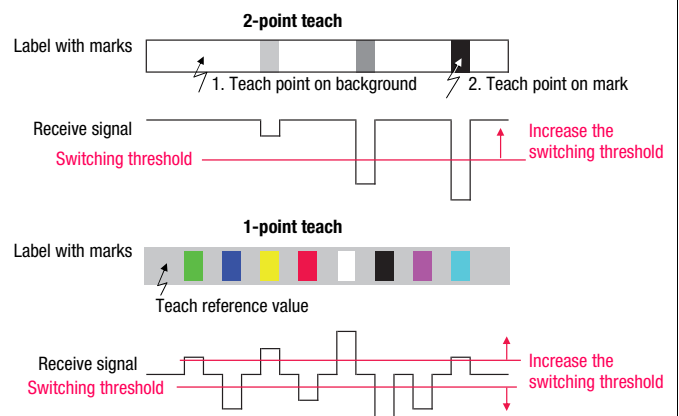

Reducing the switching threshold:

Short press of the button = small force expenditure = reduce switching threshold
 Each press of the button with a duration between 2ms and 200ms decrements the switching threshold.

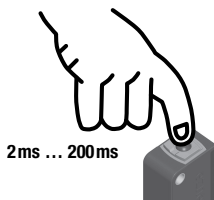

A press of the button is acknowledged by a single, brief flash of the green LED – the new switching threshold is now valid.

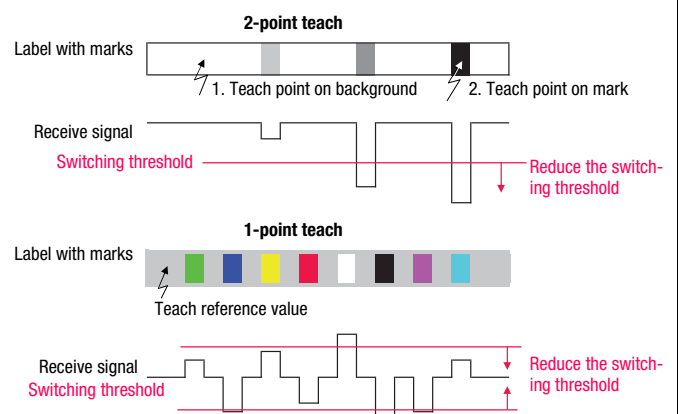

If the upper or lower end of the adjustment range is reached, the green and yellow LEDs flash at a considerably higher frequency of 8Hz for the duration of one second.

Sensor adjustments via the input IN (Pin 2)



The following description applies to PNP switching logic!

Signal level LOW $\leq 2V$

Signal level HIGH $\geq (U_B - 2V)$

With the NPN models, the signal levels are inverted!

Switching threshold in center / standard sensitivity

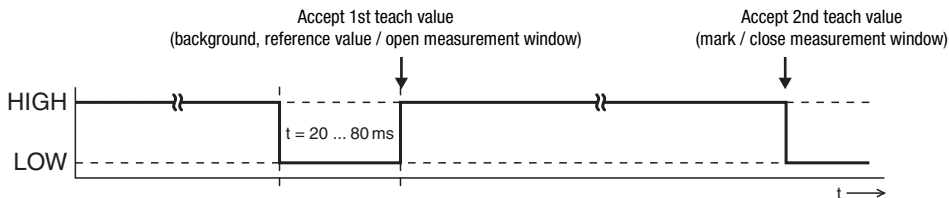

Switching threshold near the mark / high sensitivity

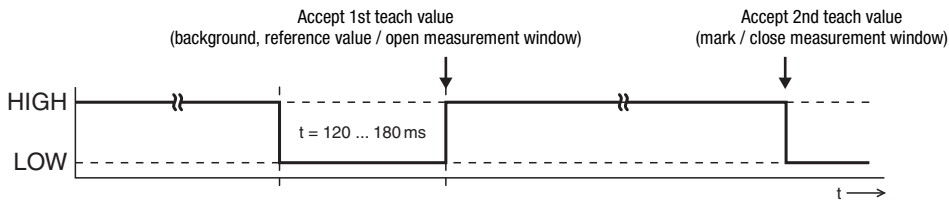

Pulse stretching ON

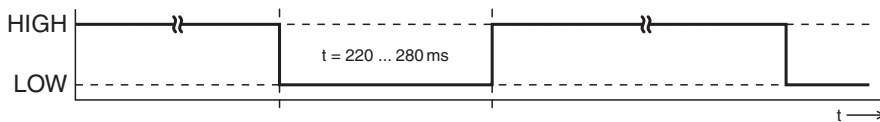

Pulse stretching OFF

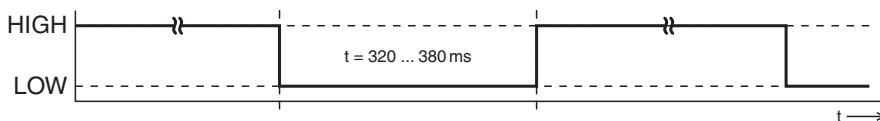

Locking the teach button via the input IN (Pin 2)



A static HIGH signal ($\geq 20ms$) at the teach input locks the teach button on the sensor if required, such that no manual operation is possible (e.g., protection from erroneous operation or manipulation).

If the teach input is not connected or if there is a static low signal, the button is unlocked and can be operated freely.

