

Technical data sheet

Rotary encoder

Part no.: 50144319

EI 1058-S06x10Y-1024T-030R

Contents

- Technical data
- Dimensioned drawings
- Electrical connection



For illustration purposes only



Technical data

Basic data

Series	EI 1xxx
Type	Incremental rotary encoder

Measurement data

Max. operating speed	6,000 r/min
Resolution	1,024 p/r

Electrical data

Protective circuit	Polarity reversal protection Short circuit protected
--------------------	---

Performance data

Supply voltage U_B	5 ... 28 V, DC
Open-circuit current	0 ... 150 mA

Time behavior

Switching frequency	300,000 Hz
---------------------	------------

Interface

Type	TTL
------	-----

Connection

Connection 1

Function	Signal OUT Voltage supply
Type of connection	Cable
Cable length	3,000 mm
Connector	radial
Sheathing material	PVC
Cable color	Gray
Number of conductors	8 -wire
Wire cross section	0.14 mm ²

Mechanical data

Housing material	Metal
Metal housing	Aluminum
Flange type	Synchro flange

Shaft

Design	Shaft
Dimension (Ø x L)	6 mm
Dimension (Ø x L)	10 mm
Start-up torque	0.5 N·m
Shaft load - axial	60 N
Shaft load - radial	120 N

Environmental data

Ambient temperature, operation	-40 ... 70 °C
Ambient temperature, storage	-40 ... 70 °C

Certifications

Degree of protection	IP 65
Standards applied	IEC 61000-6-2:2016, IEC 61000-6-4:2016 + A1
Test procedure for vibration in accordance with standard	10g IEC 68-2-6 (10...2000 Hz)

Classification

ECLASS 5.1.4	27270501
ECLASS 8.0	27270501
ECLASS 9.0	27270501
ECLASS 10.0	27270501
ECLASS 11.0	27270501
ECLASS 12.0	27270501
ECLASS 13.0	27270501
ECLASS 14.0	27270501
ETIM 5.0	EC001486
ETIM 6.0	EC001486
ETIM 7.0	EC001486
ETIM 8.0	EC001486
ETIM 9.0	EC001486

Dimensioned drawings

All dimensions in millimeters

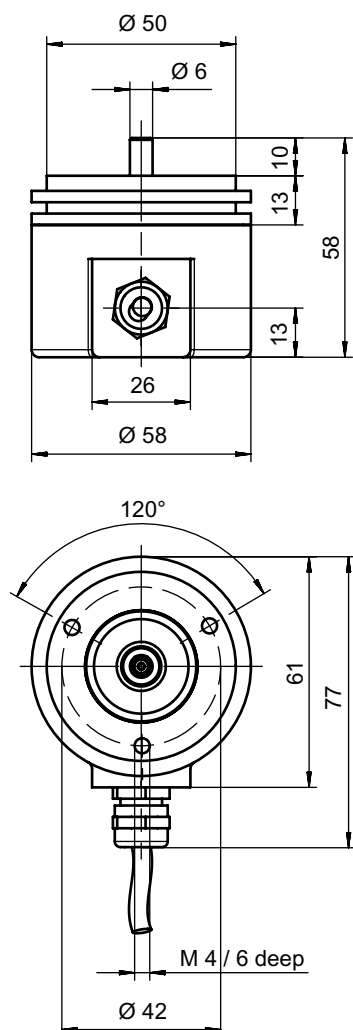

Electrical connection

Connection 1

Function	Signal OUT
	Voltage supply
Type of connection	Cable
Cable length	3,000 mm
Connector	radial
Sheathing material	PVC
Cable color	Gray
Number of conductors	8 -wire
Wire cross section	0.14 mm ²

Electrical connection

Conductor color	Conductor assignment
Brown	V+
White	GND
Green	A
Yellow	A inverted
Pink	B
Black	B inverted
Blue	Z
Red	Z inverted