

Technical data sheet

Rotary encoder

Part no.: 50139593

EI 1058-S10x20C-5000H-M23A

Contents

- Technical data
- Dimensioned drawings
- Electrical connection

Figure can vary



Technical data

Basic data

Series	EI 1xxx
Type	Incremental rotary encoder

Measurement data

Max. operating speed	6,000 r/min
Resolution	5,000 p/r

Electrical data

Protective circuit	Polarity reversal protection Short circuit protected
--------------------	---

Performance data

Supply voltage U_B	5 ... 28 V, DC
Open-circuit current	0 ... 150 mA

Time behavior

Switching frequency	300,000 Hz
---------------------	------------

Interface

Type	HTL
------	-----

Connection

Number of connections	1 Piece(s)
-----------------------	------------

Connection 1

Function	Signal OUT Voltage supply
Type of connection	Connector
Thread size	M23
Type	Male
Material	Metal
No. of pins	12 -pin
Plug outlet	Axial

Mechanical data

Housing material	Metal
Metal housing	Aluminum
Flange type	Clamping flange

Shaft

Design	Shaft
Dimension (\varnothing x L)	10 mm
Dimension (\varnothing x L)	20 mm
Start-up torque	0.5 N·m
Shaft load - axial	60 N
Shaft load - radial	120 N

Environmental data

Ambient temperature, operation	-40 ... 70 °C
Ambient temperature, storage	-40 ... 70 °C

Certifications

Degree of protection	IP 65
Standards applied	IEC 61000-6-2:2016, IEC 61000-6-4:2016 + A1
Test procedure for vibration in accordance with standard	10g IEC 68-2-6 (10...2000 Hz)

Classification

ECLASS 5.1.4	27270501
ECLASS 8.0	27270501
ECLASS 9.0	27270501
ECLASS 10.0	27270501
ECLASS 11.0	27270501
ECLASS 12.0	27270501
ECLASS 13.0	27270501
ETIM 5.0	EC001486
ETIM 6.0	EC001486
ETIM 7.0	EC001486
ETIM 8.0	EC001486

Dimensioned drawings

All dimensions in millimeters

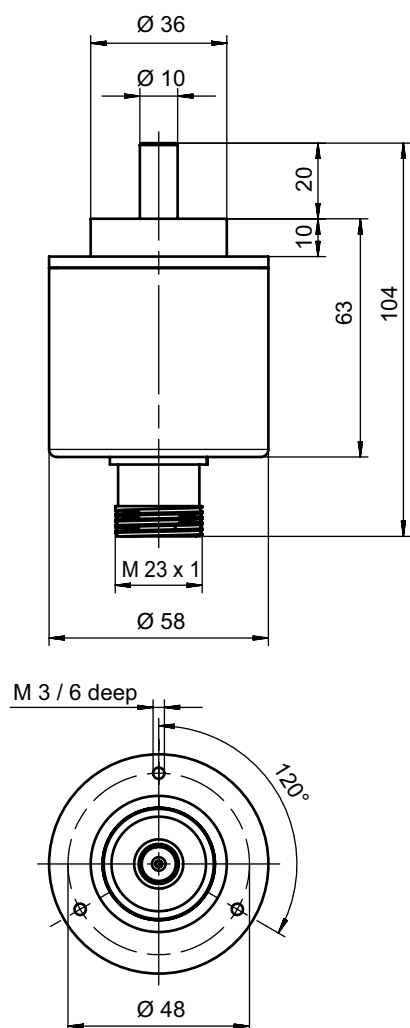

Electrical connection

Connection 1

Function	Signal OUT
	Voltage supply
Type of connection	Connector
Thread size	M23
Type	Male
Material	Metal
No. of pins	12 -pin
Plug outlet	Axial

Pin Pin assignment

1	B inverted
2	n.c.
3	Z
4	Z inverted
5	A
6	A inverted

Electrical connection

Pin	Pin assignment
7	n.c.
8	B
9	FE/SHIELD
10	GND
11	n.c.
12	V+