

## Technical data sheet

### Inductive switch

Part no.: 50128172

IS 218FM/2NO.5-5E0

#### Contents

- Technical data
- Dimensioned drawings
- Electrical connection
- Diagrams
- Operation and display
- Part number code
- Notes
- Accessories



For illustration purposes only



## Technical data

### Basic data

Series	218
Typ. operating range limit $S_n$	5 mm
Operating range $S_a$	0 ... 4 mm

### Special version

Special version	Reduction factor 1
-----------------	--------------------

### Electrical data

Protective circuit	Inductive protection
	Polarity reversal protection
	Short circuit protected

### Performance data

Supply voltage $U_B$	10 ... 30 V, DC
Residual ripple	0 ... 20 %, From $U_B$
Open-circuit current	0 ... 10 mA
Temperature drift, max. (in % of $S_r$ )	10 %, Over the entire operating temperature range
Repeatability, max. (in % of $S_r$ )	5 %, For $U_B = 20 ... 30$ VDC, ambient temperature $T_a = 23^\circ\text{C} \pm 5^\circ\text{C}$
Switching hysteresis	15 %

### Outputs

Number of digital switching outputs	1 Piece(s)
-------------------------------------	------------

### Switching outputs

Voltage type	DC
Switching current, max.	200 mA
Residual current, max.	0.1 mA
Voltage drop	$\leq 2$ V

### Switching output 1

Switching element	Transistor, NPN
Switching principle	NO (normally open)

### Time behavior

Switching frequency	100 Hz
Readiness delay	25 ms

### Connection

Number of connections	1 Piece(s)
-----------------------	------------

### Connection 1

Function	Signal OUT
	Voltage supply
Type of connection	Cable
Cable length	2,000 mm
Sheathing material	PUR
Cable color	Black
Number of conductors	3 -wire
Wire cross section	0.34 mm <sup>2</sup>

### Mechanical data

Design	Cylindrical
Thread size	M18 x 1 mm
Dimension ( $\varnothing$ x L)	18 mm x 51 mm
Type of installation	Embedded
Housing material	Stainless steel
Stainless steel housing	V2A
Sensing face material	Stainless steel, AISI 303
Net weight	118 g
Housing color	Silver
Type of fastening	Mounting thread Via optional mounting device
Standard measuring plate	18 x 18 mm <sup>2</sup> , Fe360

### Operation and display

Type of display	LED
Number of LEDs	1 Piece(s)

### Environmental data

Ambient temperature, operation	-25 ... 70 °C
--------------------------------	---------------

### Certifications

Degree of protection	IP 68
	IP 69K
Certifications	c UL US
Test procedure for EMC in accordance with standard	IEC 61000-4-2
	IEC 61000-4-3
	IEC 61000-4-4
Standards applied	IEC 60947-5-2

### Correction factors

Aluminum	1
Stainless steel	0.7
Copper	0.8
Brass	1.3
Fe360 steel	1

### Classification

Customs tariff number	85365019
ECLASS 5.1.4	27270101
ECLASS 8.0	27270101
ECLASS 9.0	27270101
ECLASS 10.0	27270101
ECLASS 11.0	27270101
ECLASS 12.0	27274001
ECLASS 13.0	27274001
ECLASS 14.0	27274001
ETIM 5.0	EC002714
ETIM 6.0	EC002714
ETIM 7.0	EC002714
ETIM 8.0	EC002714
ETIM 9.0	EC002714

# Dimensioned drawings

All dimensions in millimeters

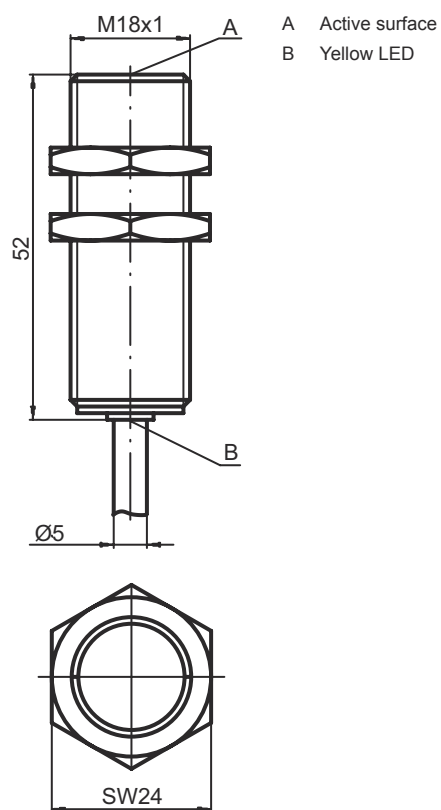

## Electrical connection

### Connection 1

Function	Signal OUT
	Voltage supply
Type of connection	Cable
Cable length	2,000 mm
Sheathing material	PUR
Cable color	Black
Number of conductors	3 -wire
Wire cross section	0.34 mm <sup>2</sup>

### Conductor color

### Conductor assignment

Brown	V+
Blue	GND
Black	OUT 1

# Diagrams

## Embedded installation

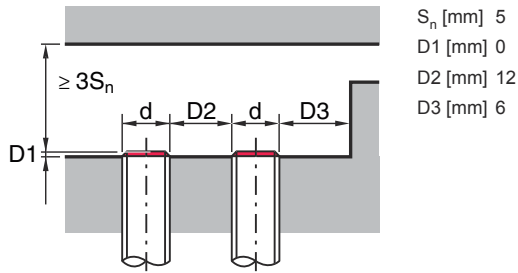

## Types with $S_n = 5.0$ mm

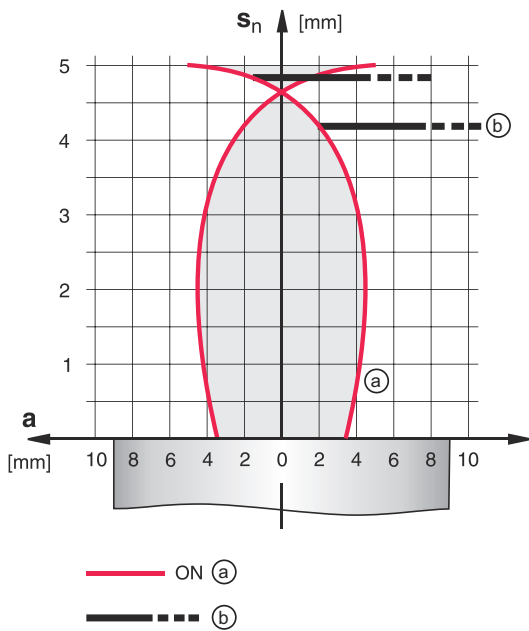

## Operation and display

LED	Display	Meaning
1	Yellow, flashing	No function reserve
	Yellow, continuous light	Switching output/switching state

## Part number code

Part designation: **ISX** *YYY ZZ/AAA.BB-CCC-DDD-DDD*

ISX	Operating principle / construction
	IS: inductive switch, standard design
	ISS: inductive switch, short construction

## Part number code



<b>YYY</b>	<p><b>Series</b></p> <p>203: series with Ø 3 mm                  204: series with Ø 4 mm                  205: series with M5 x 0.5 external thread                  206: series with Ø 6.5 mm                  208: series with M8 x 1 external thread                  212: series with M12 x 1 external thread                  218: series with M18 x 1 external thread                  230: series with M30 x 1.5 external thread                  240: series in cubic design                  244: series in cubic design                  255: series with 5 x 5 mm<sup>2</sup> cross section                  288: series with 8 x 8 mm<sup>2</sup> cross section</p>
<b>ZZ</b>	<p><b>Housing / thread</b></p> <p>MM: metal housing (active surface: plastic) / metric thread                  FM: Full-metal housing (active surface: stainless steel AISI 316L) / metric thread                  MP: metal housing (active surface: plastic) / smooth (without thread)</p>
<b>AAA</b>	<p><b>Output current / supply</b></p> <p>4NO: PNP transistor, NO contact                  4NC: PNP transistor, NC contact                  2NO: NPN transistor, NO contact                  2NC: NPN transistor, NC contact                  1NO: relay, NO contact / AC/DC                  1NC: Relay, NC contact / AC/DC                  44: 2 PNP transistor switching outputs, antivalent (NO + NC)                  22: 2 NPN transistor switching outputs, antivalent (NO + NC)</p>
<b>BB</b>	<p><b>Special equipment</b></p> <p>n/a: no special equipment                  5F: Food version                  5: housing material V2A (1.4305, AISI 303)</p>
<b>CCC</b>	<p><b>Measurement range / type of installation</b></p> <p>1E0: typ. range limit 1.0 mm / embedded installation                  1E5: typ. range limit 1.5 mm / embedded installation                  2E0: typ. range limit 2.0 mm / embedded installation                  3E0: typ. range limit 3.0 mm / embedded installation                  4E0: typ. range limit 4.0 mm / embedded installation                  5E0: typ. range limit 5.0 mm / embedded installation                  6E0: typ. range limit 6.0 mm / embedded installation                  8E0: typ. range limit 8.0 mm / embedded installation                  10E: typ. range limit 10.0 mm / embedded installation                  12E: typ. range limit 12.0 mm / embedded installation                  15E: typ. range limit 15.0 mm / embedded installation                  20E: typ. range limit 20.0 mm / embedded installation                  22E: typ. range limit 22.0 mm / embedded installation                  2N5: typ. range limit 2.5 mm / non-embedded installation                  4N0: typ. range limit 4.0 mm / non-embedded installation                  8N0: typ. range limit 8.0 mm / non-embedded installation                  10N: typ. range limit 10.0 mm / non-embedded installation                  12N: typ. range limit 12.0 mm / non-embedded installation                  14N: typ. range limit 14.0 mm / non-embedded installation                  15N: typ. range limit 15.0 mm / non-embedded installation                  20N: typ. range limit 20.0 mm / non-embedded installation                  22N: typ. range limit 22.0 mm / non-embedded installation                  25N: typ. range limit 25.0 mm / non-embedded installation                  40N: typ. range limit 40.0 mm / non-embedded installation</p>
<b>DDD</b>	<p><b>Electrical connection</b></p> <p>n/a: cable, standard length 2000 mm                  S12: M12 connector, 4-pin, axial                  200-S12: cable, length 200 mm with M12 connector, 4-pin, axial                  200-S8.3: cable, length 200 mm with M8 connector, 3-pin, axial                  S8.3: M8 connector, 3-pin, axial                  005-S8.3: cable, length 500 mm with M8 connector, 3-pin, axial                  050: cable, standard length 5000 mm, 3-wire</p>



### Note



A list with all available device types can be found on the Leuze website at [www.leuze.com](http://www.leuze.com).

## Notes

 <b>Observe intended use!</b>	
	<ul style="list-style-type: none"> <li>⌘ This product is not a safety sensor and is not intended as personnel protection.</li> <li>⌘ The product may only be put into operation by competent persons.</li> <li>⌘ Only use the product in accordance with its intended use.</li> </ul>

 <b>For UL applications:</b>	
	<ul style="list-style-type: none"> <li>⌘ For UL applications, use is only permitted in Class 2 circuits in accordance with the NEC (National Electric Code).</li> </ul>

## Accessories

### Mounting technology - Other

	Part no.	Designation	Article	Description
	50111501	MC 018K	Clamp	Diameter, inner: 18 mm Design of mounting device: Mounting clamp Fastening, at system: Through-hole mounting Mounting bracket, at device: Clampable Type of mounting device: Rigid Material: Plastic

<b>Note</b>	
	<ul style="list-style-type: none"> <li>⌘ A list with all available accessories can be found on the Leuze website in the Download tab of the article detailed page.</li> </ul>