

Technical data sheet

Inductive switch

Part no.: 50141493

ISS 230MM/44-22N-S12

Contents

- Technical data
- Dimensioned drawings
- Electrical connection
- Diagrams
- Operation and display
- Part number code
- Notes
- Accessories



For illustration purposes only



Technical data

Basic data

| | |
|----------------------------------|----------------|
| Series | 230 |
| Typ. operating range limit S_n | 22 mm |
| Operating range S_a | 0 ... 17.82 mm |

Special version

| | |
|-----------------|------------|
| Special version | Antivalent |
|-----------------|------------|

Characteristic parameters

| | |
|------|-----------|
| MTTF | 850 years |
|------|-----------|

Electrical data

| | |
|--------------------|------------------------------|
| Protective circuit | Polarity reversal protection |
| | Short circuit protected |
| | Transient protection |

Performance data

| | |
|--|------------------------|
| Supply voltage U_B | 10 ... 36 V, DC |
| Residual ripple | 0 ... 10 %, From U_B |
| Open-circuit current | 0 ... 16 mA |
| Temperature drift, max. (in % of S_r) | 19 % |
| Repeatability, max. (in % of S_r) | 10 % |
| Switching hysteresis | 20 % |

Outputs

| | |
|-------------------------------------|------------|
| Number of digital switching outputs | 2 Piece(s) |
|-------------------------------------|------------|

Switching outputs

| | |
|-------------------------|---------|
| Voltage type | DC |
| Switching current, max. | 200 mA |
| Residual current, max. | 0.05 mA |
| Voltage drop | ≤ 2 V |

Switching output 1

| | |
|---------------------|-------------------------|
| Switching element | Transistor, PNP |
| Switching principle | NO contact – Antivalent |

Switching output 2

| | |
|---------------------|-------------------------|
| Switching element | Transistor, PNP |
| Switching principle | NC contact – Antivalent |

Time behavior

| | |
|---------------------|----------|
| Switching frequency | 1,000 Hz |
| Readiness delay | 50 ms |

Connection

| | |
|-----------------------|------------|
| Number of connections | 1 Piece(s) |
|-----------------------|------------|

Connection 1

| | |
|--------------------|----------------|
| Function | Signal OUT |
| | Voltage supply |
| Type of connection | Connector |
| Thread size | M12 |
| Type | Male |
| Material | Metal |
| No. of pins | 4 -pin |
| Encoding | A-coded |

Mechanical data

| | |
|--------------------------|---------------------------------|
| Design | Cylindrical |
| Thread size | M30 x 1.5 mm |
| Dimension (Ø x L) | 30 mm x 67 mm |
| Type of installation | Non-embedded |
| Housing material | Metal |
| Metal housing | Nickel-plated brass |
| Sensing face material | Plastic, Polybutylene (PBT) |
| Net weight | 82 g |
| Housing color | Gray |
| | Silver |
| Type of fastening | Mounting thread |
| Standard measuring plate | 66 x 66 mm ² , Fe360 |

Operation and display

| | |
|-----------------|------------|
| Type of display | LED |
| Number of LEDs | 1 Piece(s) |

Environmental data

| | |
|--------------------------------|---------------|
| Ambient temperature, operation | -40 ... 70 °C |
| Ambient temperature, storage | -40 ... 80 °C |

Certifications

| | |
|--|--------------------------|
| Degree of protection | IP 67 |
| Protection class | II |
| Certifications | c UL US |
| Test procedure for EMC in accordance with standard | EN 61000-4-2, -3, -4, -8 |

Correction factors

| | |
|-----------------|-----|
| Aluminum | 0.5 |
| Stainless steel | 0.7 |
| Copper | 0.3 |
| Brass | 0.5 |
| Fe360 steel | 1 |

Classification

| | |
|-----------------------|----------|
| Customs tariff number | 85365080 |
| ECLASS 5.1.4 | 27270101 |
| ECLASS 8.0 | 27270101 |
| ECLASS 9.0 | 27270101 |
| ECLASS 10.0 | 27270101 |
| ECLASS 11.0 | 27270101 |
| ECLASS 12.0 | 27274001 |
| ECLASS 13.0 | 27274001 |
| ECLASS 14.0 | 27274001 |
| ETIM 5.0 | EC002714 |
| ETIM 6.0 | EC002714 |
| ETIM 7.0 | EC002714 |
| ETIM 8.0 | EC002714 |
| ETIM 9.0 | EC002714 |

Dimensioned drawings

All dimensions in millimeters

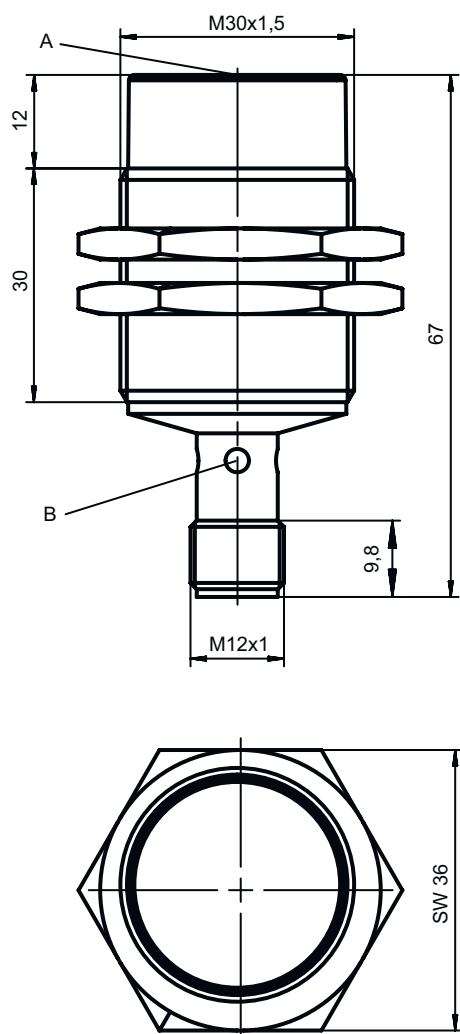

Electrical connection

Connection 1

| | |
|--------------------|----------------|
| Function | Signal OUT |
| | Voltage supply |
| Type of connection | Connector |
| Thread size | M12 |
| Type | Male |
| Material | Metal |
| No. of pins | 4 -pin |
| Encoding | A-coded |

| Pin | Pin assignment |
|-----|----------------|
| 1 | V+ |
| 2 | OUT 2 |
| 3 | GND |
| 4 | OUT 1 |

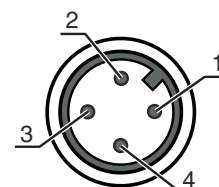

Diagrams

Non-embedded installation

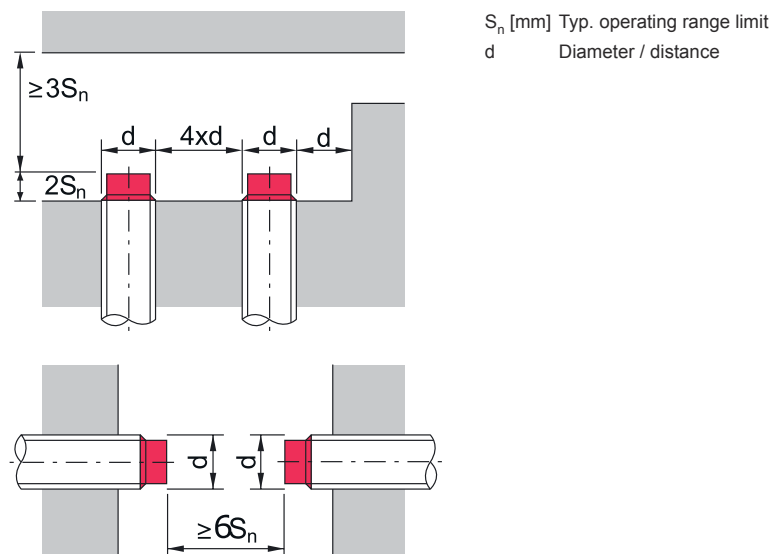

Operation and display

| LED | Display | Meaning |
|-----|--------------------------|----------------------------------|
| 1 | Yellow, continuous light | Switching output/switching state |
| | Yellow, flashing | Overload - output |

Part number code

Part designation: ISX YYY ZZ/AAA.BB-CCC-DDD-DDD

| | |
|------------|--|
| ISX | Operating principle / construction IS: inductive switch, standard design ISS: inductive switch, short construction |
| YYY | Series 203: series with Ø 3 mm 204: series with Ø 4 mm 205: series with M5 x 0.5 external thread 206: series with Ø 6.5 mm 208: series with M8 x 1 external thread 212: series with M12 x 1 external thread 218: series with M18 x 1 external thread 230: series with M30 x 1.5 external thread 240: series in cubic design 244: series in cubic design 255: series with 5 x 5 mm ² cross section 288: series with 8 x 8 mm ² cross section |
| ZZ | Housing / thread MM: metal housing (active surface: plastic) / metric thread FM: Full-metal housing (active surface: stainless steel AISI 316L) / metric thread MP: metal housing (active surface: plastic) / smooth (without thread) |
| AAA | Output current / supply 4NO: PNP transistor, NO contact 4NC: PNP transistor, NC contact 2NO: NPN transistor, NO contact 2NC: NPN transistor, NC contact 1NO: relay, NO contact / AC/DC 1NC: Relay, NC contact / AC/DC 44: 2 PNP transistor switching outputs, antivalent (NO + NC) 22: 2 NPN transistor switching outputs, antivalent (NO + NC) |
| BB | Special equipment n/a: no special equipment 5F: Food version 5: housing material V2A (1.4305, AISI 303) |

Part number code

| | |
|------------|---|
| CCC | <p>Measurement range / type of installation</p> <p>1E0: typ. range limit 1.0 mm / embedded installation 1E5: typ. range limit 1.5 mm / embedded installation 2E0: typ. range limit 2.0 mm / embedded installation 3E0: typ. range limit 3.0 mm / embedded installation 4E0: typ. range limit 4.0 mm / embedded installation 5E0: typ. range limit 5.0 mm / embedded installation 6E0: typ. range limit 6.0 mm / embedded installation 8E0: typ. range limit 8.0 mm / embedded installation 10E: typ. range limit 10.0 mm / embedded installation 12E: typ. range limit 12.0 mm / embedded installation 15E: typ. range limit 15.0 mm / embedded installation 20E: typ. range limit 20.0 mm / embedded installation 22E: typ. range limit 22.0 mm / embedded installation 2N5: typ. range limit 2.5 mm / non-embedded installation 4N0: typ. range limit 4.0 mm / non-embedded installation 8N0: typ. range limit 8.0 mm / non-embedded installation 10N: typ. range limit 10.0 mm / non-embedded installation 12N: typ. range limit 12.0 mm / non-embedded installation 14N: typ. range limit 14.0 mm / non-embedded installation 15N: typ. range limit 15.0 mm / non-embedded installation 20N: typ. range limit 20.0 mm / non-embedded installation 22N: typ. range limit 22.0 mm / non-embedded installation 25N: typ. range limit 25.0 mm / non-embedded installation 40N: typ. range limit 40.0 mm / non-embedded installation</p> |
| DDD | <p>Electrical connection</p> <p>n/a: cable, standard length 2000 mm S12: M12 connector, 4-pin, axial 200-S12: cable, length 200 mm with M12 connector, 4-pin, axial 200-S8.3: cable, length 200 mm with M8 connector, 3-pin, axial S8.3: M8 connector, 3-pin, axial 005-S8.3: cable, length 500 mm with M8 connector, 3-pin, axial 050: cable, standard length 5000 mm, 3-wire</p> |





Notes

| | |
|------------------------------|---|
| Observe intended use! | |
| | <ul style="list-style-type: none"> ⚠ This product is not a safety sensor and is not intended as personnel protection. ⚠ The product may only be put into operation by competent persons. ⚠ Only use the product in accordance with its intended use. |

| | |
|-----------------------------|---|
| For UL applications: | |
| | <ul style="list-style-type: none"> ⚠ For UL applications, use is only permitted in Class 2 circuits in accordance with the NEC (National Electric Code). |

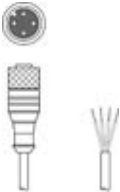
Accessories



Connection technology - Connection cables

| | Part no. | Designation | Article | Description |
|--|----------|--------------------|------------------|---|
|  | 50130654 | KD U-M12-4A-P1-020 | Connection cable | Connection 1: Connector, M12, Axial, Female, A-coded, 4 -pin Connector, LED: No Connection 2: Open end Shielded: No Cable length: 2.000 mm Sheathing material: PUR |
|  | 50130657 | KD U-M12-4A-P1-050 | Connection cable | Connection 1: Connector, M12, Axial, Female, A-coded, 4 -pin Connector, LED: No Connection 2: Open end Shielded: No Cable length: 5.000 mm Sheathing material: PUR |
|  | 50130648 | KD U-M12-4A-V1-020 | Connection cable | Connection 1: Connector, M12, Axial, Female, A-coded, 4 -pin Connector, LED: No Connection 2: Open end Shielded: No Cable length: 2.000 mm Sheathing material: PVC |
|  | 50130652 | KD U-M12-4A-V1-050 | Connection cable | Connection 1: Connector, M12, Axial, Female, A-coded, 4 -pin Connector, LED: No Connection 2: Open end Shielded: No Cable length: 5.000 mm Sheathing material: PVC |

Mounting technology - Mounting brackets

| | Part no. | Designation | Article | Description |
|--|----------|-------------|------------------|--|
|  | 50113510 | BT D30M.5 | Mounting bracket | Diameter, inner: 30.2 mm Design of mounting device: Angle, L-shape Fastening, at system: Through-hole mounting Mounting bracket, at device: Screw type Type of mounting device: Rigid Material: Stainless steel |

Mounting technology - Other

| | Part no. | Designation | Article | Description |
|--|----------|-------------|---------|---|
|  | 50111503 | MC 030K | Clamp | Diameter, inner: 30 mm Design of mounting device: Mounting clamp Fastening, at system: Through-hole mounting Mounting bracket, at device: Clampable Type of mounting device: Rigid Material: Plastic |
|  | 50111504 | MC 030K-LS | Clamp | Diameter, inner: 30 mm Design of mounting device: Mounting clamp Fastening, at system: Through-hole mounting Mounting bracket, at device: Clampable with limit stop Type of mounting device: Rigid Material: Plastic |

Accessories

Note



🔗 A list with all available accessories can be found on the Leuze website in the Download tab of the article detailed page.