

Technical data sheet

Capacitive sensor

Part no.: 50136521

LCS-2M12B-F03PNO-K020V

Contents

- Technical data
- Dimensioned drawings
- Electrical connection
- Circuit diagrams
- Operation and display
- Part number code
- Notes
- Accessories



For illustration purposes only



Technical data

Basic data

Series	LCS-2
Switching distance S_n	1 ... 3 mm
Assured switching distance	2.4 mm

Electrical data

Protective circuit	Polarity reversal protection Short circuit protected
--------------------	---

Performance data

Supply voltage U_B	10 ... 30 V, DC
Residual ripple	0 ... 10 %
Open-circuit current	10 mA
Temperature drift, max. (in % of S_r)	10 %
Repeatability, max. (in % of S_r)	5 %
Rated operating current	200 mA

Outputs

Number of digital switching outputs	1 Piece(s)
-------------------------------------	------------

Switching outputs

Type	Digital switching output
Voltage type	DC

Switching output 1

Assignment	Connection 1, conductor 2
Switching element	Transistor, PNP
Switching principle	NO (normally open)

Time behavior

Switching frequency	100 Hz
---------------------	--------

Connection

Number of connections	1 Piece(s)
-----------------------	------------

Connection 1

Function	Signal OUT Voltage supply
Type of connection	Cable
Cable length	2,000 mm
Sheathing material	PVC
Number of conductors	3 -wire
Wire cross section	0.35 mm ²

Mechanical data

Design	Cylindrical
Thread size	M12 x 1 mm
Dimension (\varnothing x L)	12 mm x 55 mm
Type of installation	Embedded
Housing material	Metal
Sensing face material	Plastic, Polybutylene (PBT)
Cover material	Plastic, Polybutylene (PBT)

Operation and display

Type of display	LED
Number of LEDs	1 Piece(s)
Operational controls	Multiturn potentiometer
Function of the operational control	Sensitivity adjustment
Switching distance, adjustable	Yes

Environmental data

Ambient temperature, operation	-25 ... 70 °C
--------------------------------	---------------

Certifications

Degree of protection	IP 67
Protection class	III
Standards applied	IEC 60947-5-2

Correction factors

Acetone	0.75
Acrylic resin	0.1 ... 0.25
Alcohol	0.85
Ammonia	0.7 ... 0.85
Aniline	0.4
Gasoline	0.1
Celluloid	0.15
Liquid chlorine	0.1
Ebonite	0.15
Epoxy resin	0.15 ... 0.35
Crude oil	0.05
Ethanol	0.85
Ethylene glycol	0.93
Freon R22 and 502 (liquid)	0.35
Grain	0.15 ... 0.3
Glass	0.2 ... 0.55
Glycerin	0.98
Rubber	0.15 ... 0.9
Wood, wet	0.6 ... 0.85
Wood, dry	0.1 ... 0.4
Carbon dioxide	0
Air	0
Marble	0.5
Flour	0.05
Melamine resin	0.25 ... 0.55
Milk powder	0.2
Nylon	0.2 ... 0.3
Oil-containing paper	0.25
Paper	0.1
Polyamide	0.3
Polyester resin	0.15 ... 0.5
Pressboard	0.1 ... 0.3
PTFE	0.1
Quartz glass	0.2
Salt	0.35
Sand	0.15 ... 0.3
Water	1
Cement dust	0.25
Sugar	0.15

Technical data

Customs tariff number	85365019
ECLASS 5.1.4	27270102
ECLASS 8.0	27270102
ECLASS 9.0	27270102
ECLASS 10.0	27270102
ECLASS 11.0	27270102
ECLASS 12.0	27274201
ECLASS 13.0	27274201
ECLASS 14.0	27274201
ETIM 5.0	EC002715
ETIM 6.0	EC002715
ETIM 7.0	EC002715
ETIM 8.0	EC002715
ETIM 9.0	EC002715

Dimensioned drawings

All dimensions in millimeters

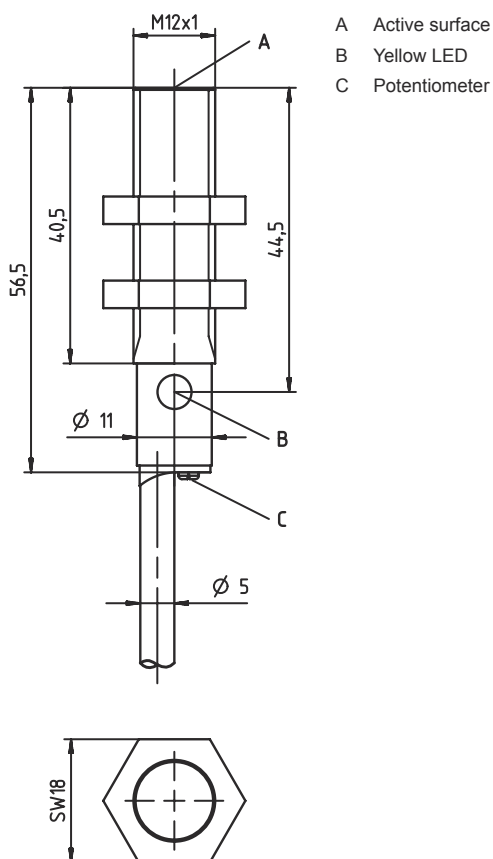

Electrical connection

Connection 1

Function	Signal OUT
	Voltage supply
Type of connection	Cable
Cable length	2,000 mm
Sheathing material	PVC
Number of conductors	3 -wire
Wire cross section	0.35 mm ²

Conductor color

Conductor assignment

Brown	10 - 30 V DC
Black	OUT
Blue	GND

Circuit diagrams

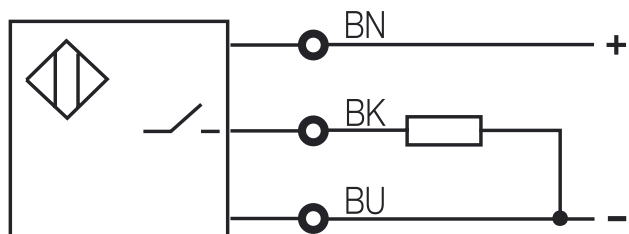

Operation and display

LED	Display	Meaning
1	Yellow, continuous light	Switching output/switching state

Part number code

Part designation: **LCS-ABBBC-DDDEFF-GHHHIJJJ KK**



LCS	Operating principle LCS: capacitive sensor
A	Series 1: series 1 "Extended" 2: series 2 "Advanced"
BBB	Design M12: series with M12 x 1 external thread M18: series with M18 x 1 external thread M30: series with M30 x 1.5 external thread Q40: series in cubic design, length 40 mm Q54: series in cubic design, length 54 mm
C	Housing material B: Brass M: metal P: plastic/PBT T: PTFE

Part number code

DDD	Measurement range / type of installation F03: typ. range limit 3.0 mm / embedded installation F04: typ. range limit 4.0 mm / embedded installation F05: typ. range limit 5.0 mm / embedded installation F06: typ. range limit 6.0 mm / embedded installation F08: typ. range limit 8.0 mm / embedded installation F10: typ. range limit 10.0 mm / embedded installation F15: typ. range limit 15.0 mm / embedded installation F20: typ. range limit 20.0 mm / embedded installation N06: typ. range limit 6.0 mm / non-embedded installation N08: typ. range limit 8.0 mm / non-embedded installation N15: typ. range limit 15.0 mm / non-embedded installation N25: typ. range limit 25.0 mm / non-embedded installation N30: typ. range limit 30.0 mm / non-embedded installation
E	Output function B: NC and NO contact N: NPN P: PNP
FF	Switching NC: Normally closed contact NO: normally open contact NP: programmable
G	Connection cable K: Cable n/a: no cable
HHH	Cable length 020: length 2,000 mm 003: length 300 mm n/a: no cable
I	Cable material P: PUR T: PTFE V: PVC
JJJ	Electrical connection M08: M8 connector, 3-pin M12: M12 connector, 4-pin (plug)
KK	Special equipment L: IO-Link interface T: teach-in n/a: no special equipment

Note	
	ⓘ A list with all available device types can be found on the Leuze website at www.leuze.com .

Notes

 Observe intended use!	
	ⓘ This product is not a safety sensor and is not intended as personnel protection. ⓘ The product may only be put into operation by competent persons. ⓘ Only use the product in accordance with its intended use.

Accessories

Mounting technology - Other

	Part no.	Designation	Article	Description
	50111499	MC 012K	Clamp	Diameter, inner: 12 mm Design of mounting device: Mounting clamp Fastening, at system: Through-hole mounting Mounting bracket, at device: Clampable Type of mounting device: Rigid Material: Plastic

Note	
	A list with all available accessories can be found on the Leuze website in the Download tab of the article detailed page.