

Technical data sheet Optical distance sensor

Part no.: 50113698

AMS 335i 120 H



For illustration purposes only

Contents

- Technical data
- Dimensioned drawings
- Electrical connection
- Operation and display
- Part number code
- Notes
- Further information
- Accessories



CDRH

CANopen



Technical data

Basic data

Series	AMS 300i
Application	Collision protection of cranes / gantry cranes Positioning of electroplating plants Positioning of skillet systems and side-tracking skates Positioning of stacker cranes
Order guide	Reflective tape must be ordered separately

Special version

Special version	Heating
-----------------	---------

Characteristic parameters

MTTF	31 years
------	----------

Optical data

Light source	Laser, Red
Wavelength	655 nm
Laser class	2, IEC/EN 60825-1:2014
Transmitted-signal shape	Modulated
Light spot size [at sensor distance]	100 mm [120,000 mm]
Type of light spot geometry	Round

Measurement data

Measurement value calculation time	8 ms
Measurement range	200 ... 120,000 mm
Resolution	0.001 ... 10 mm
Accuracy	2 mm
Reproducibility (3 sigma)	1.5 mm
Temperature drift	0.01 ... 0.1 mm/K
Max. traverse rate	10 m/s

Electrical data

Protective circuit	No information
Performance data	
Supply voltage U_B	18 ... 30 V, DC

Interface

Type	CANopen
CANopen	
Transmission speed	10 ... 1,000 kBit/s

Connection

Number of connections	4 Piece(s)
Connection 1	
Function	BUS IN Data interface
Type of connection	Connector
Designation on device	BUS IN
Thread size	M12
Type	Male
Material	Metal
No. of pins	5 -pin
Encoding	A-coded

Connection 2

Function	BUS OUT Data interface
Type of connection	Connector
Designation on device	BUS OUT
Thread size	M12
Type	Female
No. of pins	5 -pin
Encoding	A-coded

Connection 3

Function	PWR / SW IN / OUT Voltage supply
Type of connection	Connector
Designation on device	PWR
Thread size	M12
Type	Male
No. of pins	5 -pin
Encoding	A-coded

Connection 4

Function	Service interface
Type of connection	Connector
Designation on device	SERVICE
Thread size	M12
Type	Female
No. of pins	5 -pin
Encoding	A-coded

Mechanical data

Design	Cubic
Dimension (W x H x L)	84 mm x 166.5 mm x 159 mm
Housing material	Metal
Metal housing	Diecast zinc/aluminum
Lens cover material	Glass
Net weight	2,450 g
Housing color	Gray Red
Type of fastening	Through-hole mounting

Operation and display

Type of display	LC Display LED
Number of LEDs	2 Piece(s)
Operational controls	Membrane keyboard

Environmental data

Ambient temperature, operation	-30 ... 50 °C
Ambient temperature, storage	-30 ... 70 °C
Relative humidity (non-condensing)	90 %

Certifications

Degree of protection	IP 65
Protection class	III
Certifications	c UL US

Technical data

Customs tariff number	90318020
ECLASS 5.1.4	27270801
ECLASS 8.0	27270801
ECLASS 9.0	27270801
ECLASS 10.0	27270801
ECLASS 11.0	27270801
ECLASS 12.0	27270916
ECLASS 13.0	27270916
ETIM 5.0	EC001825
ETIM 6.0	EC001825
ETIM 7.0	EC001825
ETIM 8.0	EC001825

Dimensioned drawings

All dimensions in millimeters

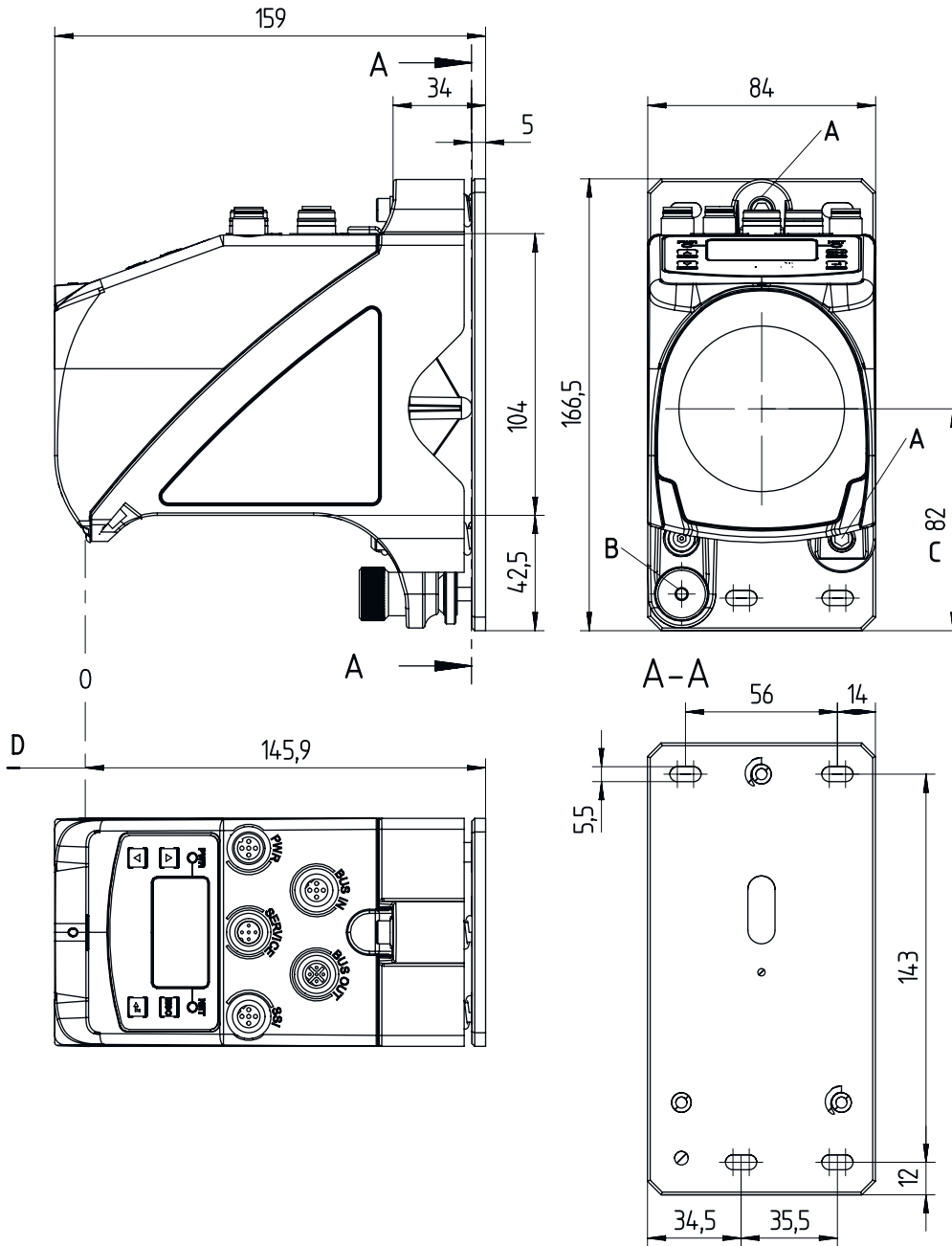

- A M5 screw for alignment
- B Knurled nut with WAF4 hexagon socket and M5 nut for securing
- C Optical axis
- D Zero point of the distance to be measured

Electrical connection

Connection 1

BUS IN

Function	BUS IN Data interface
Type of connection	Connector
Thread size	M12
Type	Male
Material	Metal
No. of pins	5 -pin
Encoding	A-coded

Pin	Pin assignment
1	Drain
2	NC
3	NC
4	CAN H
5	CAN L

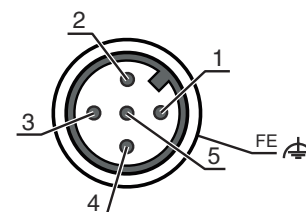

Connection 2

BUS OUT

Function	BUS OUT Data interface
Type of connection	Connector
Thread size	M12
Type	Female
Material	Metal
No. of pins	5 -pin
Encoding	A-coded

Pin	Pin assignment
1	Drain
2	n.c.
3	n.c.
4	CAN H
5	CAN L

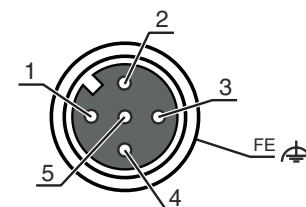

Connection 3

PWR

Function	PWR / SW IN / OUT Voltage supply
Type of connection	Connector
Thread size	M12
Type	Male
Material	Metal
No. of pins	5 -pin
Encoding	A-coded

Pin	Pin assignment
1	VIN
2	I/O 1
3	GND
4	I/O 2
5	FE

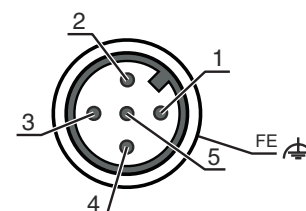

Electrical connection

Connection 4

SERVICE

Function	Service interface
Type of connection	Connector
Thread size	M12
Type	Female
Material	Metal
No. of pins	5 -pin
Encoding	A-coded

Pin Pin assignment

1	n.c.
2	RS 232-TX
3	GND
4	RS 232-RX
5	n.c.

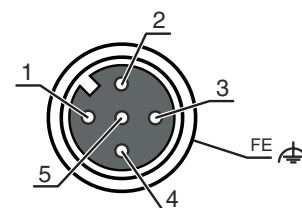

Operation and display

LED	Display	Meaning
1 PWR	Off	No supply voltage
	Green, flashing	Voltage connected / no measurement value output / initialization running
	Green, continuous light	Device OK, measurement value output
	Red, flashing	Device OK, warning set
	Red, continuous light	No measurement value output
	Orange, continuous light	No data transmission
2 BUS	Off	No supply voltage
	Green, flashing	"PRE-OPERATIONAL" and "STOPPED" state
	Green, continuous light	"OPERATIONAL" state
	Red, flashing	Configuration error
	Red, continuous light	Device not on the bus
	Red/green, flashing alternately	Bus error

Part number code

Part designation: AMS 3XXi YYY Z AAA

AMS	Operating principle AMS: absolute measurement system
3XXi	Series/interface (integrated fieldbus technology) 300i: RS 422/RS 232 301i: RS 485 304i: PROFIBUS DP / SSI 308i: TCP/IP 335i: CANopen 338i: EtherCAT 348i: PROFINET RT 355i: DeviceNet 358i: EtherNet/IP 384i: Interbus

Part number code

YYY	Operating range 40: max. operating range in m 120: max. operating range in m 200: max. operating range in m 300: max. operating range in m
Z	Special equipment H: With heating
AAA	Interface SSI: with SSI interface

Note

	<ul style="list-style-type: none"> A list with all available device types can be found on the Leuze website at www.leuze.com.
----------------------------------------------------------------------------------	---------------------------------------------------------------------------------------------------------------------------------------------------------------------------------

Notes

Observe intended use!

	<ul style="list-style-type: none"> This product is not a safety sensor and is not intended as personnel protection. The product may only be put into operation by competent persons. Only use the product in accordance with its intended use.
----------------------------------------------------------------------------------	---------------------------------------------------------------------------------------------------------------------------------------------------------------------------------------------------------------------------------------------------------------------------------

ATTENTION! LASER RADIATION – CLASS 2 LASER PRODUCT

	<p>Do not stare into beam! The device satisfies the requirements of IEC/EN 60825-1:2014 safety regulations for a product of laser class 2 as well as the U.S. 21 CFR 1040.10 regulations with deviations corresponding to Laser Notice No. 56 from May 08, 2019.</p> <ul style="list-style-type: none"> Never look directly into the laser beam or in the direction of reflected laser beams! If you look into the beam path over a longer time period, there is a risk of injury to the retina. Do not point the laser beam of the device at persons! Interrupt the laser beam using a non-transparent, non-reflective object if the laser beam is accidentally directed towards a person. When mounting and aligning the device, avoid reflections of the laser beam off reflective surfaces! CAUTION! Use of controls or adjustments or performance of procedures other than specified herein may result in hazardous light exposure. Observe the applicable statutory and local laser protection regulations. The device must not be tampered with and must not be changed in any way. There are no user-serviceable parts inside the device. Repairs must only be performed by Leuze electronic GmbH + Co. KG.
------------------------------------------------------------------------------------	---------------------------------------------------------------------------------------------------------------------------------------------------------------------------------------------------------------------------------------------------------------------------------------------------------------------------------------------------------------------------------------------------------------------------------------------------------------------------------------------------------------------------------------------------------------------------------------------------------------------------------------------------------------------------------------------------------------------------------------------------------------------------------------------------------------------------------------------------------------------------------------------------------------------------------------------------------------------------------------------------------------------------------------------------------------------------------------------------------------------------------------------------------------------------------------------------------------------------------------------------------------------------------------------------------------------------------------------------

NOTE

	<p>Affix laser information and warning signs! Laser information and warning signs are affixed to the device. In addition, self-adhesive laser information and warning signs (stick-on labels) are supplied in several languages.</p> <ul style="list-style-type: none"> Affix the laser information sheet to the device in the language appropriate for the place of use. When using the device in the US, use the stick-on label with the "Complies with 21 CFR 1040.10" note. Affix the laser information and warning signs near the device if no signs are attached to the device (e.g. because the device is too small) or if the attached laser information and warning signs are concealed due to the installation position. Affix the laser information and warning signs so that they are legible without exposing the reader to the laser radiation of the device or other optical radiation.
------------------------------------------------------------------------------------	-------------------------------------------------------------------------------------------------------------------------------------------------------------------------------------------------------------------------------------------------------------------------------------------------------------------------------------------------------------------------------------------------------------------------------------------------------------------------------------------------------------------------------------------------------------------------------------------------------------------------------------------------------------------------------------------------------------------------------------------------------------------------------------------------------------------------------------------------------------------------------------------------------------------------------------------------------------

Further information

- For UL applications, use is only permitted in Class 2 circuits in accordance with the NEC (National Electric Code).
- Use as safety-related component within the safety function is possible, if the component combination is designed correspondingly by the machine manufacturer.

Accessories

Connection technology - Connection cables

	Part no.	Designation	Article	Description
	50132079	KD U-M12-5A-V1-050	Connection cable	Connection 1: Connector, M12, Axial, Female, A-coded, 5 -pin Connector, LED: No Connection 2: Open end Shielded: No Cable length: 5.000 mm Sheathing material: PVC

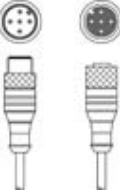

Connection technology - Interconnection cables

	Part no.	Designation	Article	Description
	50114698	KB DN/CAN-5000 SBA	Interconnection cable	Suitable for interface: DeviceNet, CANopen Connection 1: Connector, M12, Axial, Male, A-coded, 5 -pin Connection 2: Connector, M12, Axial, Female, A-coded, 5 -pin Shielded: Yes Cable length: 5,000 mm Sheathing material: PUR

Connection technology - Terminating resistors

	Part no.	Designation	Article	Description
	50040099	TS 01-5-SA	Terminator plug	Suitable for: DeviceNet, CANopen Function: Bus termination Connection 1: Connector, M12, Axial, Male, A-coded, 5 -pin

Reflective tapes for distance sensors

	Part no.	Designation	Article	Description
	50115021	Reflexfolie 500x500mm-H	Reflector	Special version: Heating Supply voltage: 230 V, AC Design: Rectangular Reflective surface: 500 mm x 500 mm Base material: Aluminum Fastening: Mounting plate, Through-hole mounting
	50104362	Reflexfolie 500x500mm-S	Reflective tape	Design: Rectangular Reflective surface: 500 mm x 500 mm Chemical designation of the material: PMMA Fastening: Adhesive

Accessories

Deflecting mirror

	Part no.	Designation	Article	Description
	50104479	US AMS 01	Deflecting mirror	Type of fastening: Through-hole mounting

Services

	Part no.	Designation	Article	Description
	S981001	CS10-S-110	Start-up support	<p>Details: Performed at location of customer's choosing, duration: max. 10 hours.</p> <p>Conditions: Devices and connection cables are already mounted, price not including travel costs and, if applicable, accommodation expenses.</p> <p>Restrictions: No mechanical (mounting) and electrical (wiring) work performed, no changes (attachments, wiring, programming) to third-party components in the nearby environment.</p>
	S981005	CS10-T-110	Product training	<p>Details: Location and content to be agreed upon, duration: max. 10 hours.</p> <p>Conditions: Price not including travel costs and, if applicable, accommodation expenses.</p> <p>Restrictions: Travel costs and accommodation expenses charged separately and according to expenditure.</p>

Note



A list with all available accessories can be found on the Leuze website in the Download tab of the article detailed page.