

Technical data sheet

Distance diffuse sensor with background suppression

Part no.: 50148589

ODT25B/L6X.32-2500-S12

Contents

- Technical data
- Dimensioned drawings
- Electrical connection
- Diagrams
- Operation and display
- Notes
- Further information
- Accessories



For illustration purposes only



Technical data

Basic data

Series	25B
Operating principle	Distance diffuse sensor with background suppression

Special version

Special version	2 independent switching outputs Measurement value output
-----------------	---

Optical data

Black-white error	± 50 mm (2 ... 90 % diffuse reflection)
Operating range	0.05 ... 2.5 m
Operating range	Guaranteed operating range
Operating range limit, white 90%	0.05 ... 3 m
Adjustment range	150 ... 3,000 mm, At 90% diffuse reflection
Beam path	Focused
Light source	LED, Infrared
Wavelength	850 nm
Transmitted-signal shape	Pulsed
LED group	Exempt group (in acc. with EN 62471)
Type of light spot geometry	square

Measurement data

Measurement range	50 ... 3,000 mm
Resolution	1.0 mm with active average value filter
Accuracy	-100 ... 100 mm
Reproducibility (1 sigma)	-15 ... 15 mm, For measurement range 50 to 2500 mm, depending on diffuse reflectance and object distance, at 20°C after 20 min. warmup time, measurement object ≥ 50x50 mm ² , with average value filter 10 (factory settings)
Measurement value output	via IO-Link
Temperature drift	-13 ... 13 mm/K
Optical distance measurement principle	Time of flight

Electrical data

Protective circuit	Polarity reversal protection Short circuit protected Transient protection
--------------------	---

Performance data

Supply voltage U_B	18 ... 30 V, DC, Incl. residual ripple
Residual ripple	0 ... 15 %, From U_B
Open-circuit current	0 ... 32 mA
Switching hysteresis	30 mm, Adjustable
Switching hysteresis (reserve)	30 mm, Adjustable

Outputs

Number of digital switching outputs	2 Piece(s)
Switching outputs	
Voltage type	DC
Switching current, max.	50 mA
Switching voltage	high: ≥(U_B -2V) low: ≤ 2 V

Switching output 1

Assignment	Connection 1, pin 4
Switching element	Transistor, Push-pull
Switching principle	IO-Link / light switching (PNP)/dark switching (NPN)

Switching output 2

Assignment	Connection 1, pin 2
Switching element	Transistor, Push-pull
Switching principle	Light switching (PNP)/dark switching (NPN)

Time behavior

Switching frequency	2 ... 30 Hz, depending on diffuse reflectance
Response time	70 ms, depending on diffuse reflectance
Readiness delay	300 ms

Interface

Type	IO-Link
IO-Link	
COM mode	COM2
Profile	Smart sensor profile
Min. cycle time	COM2 = 4 ms
Frame type	2.V
Specification	V1.1
Device ID	2149 (0x000865)
SIO-mode support	Yes

Connection

Connection 1	
Function	Signal OUT Voltage supply
Type of connection	Connector
Thread size	M12
Type	Male
Material	Plastic
No. of pins	5 -pin
Encoding	A-coded

Mechanical data

Dimension (W x H x L)	15 mm x 38.9 mm x 28.7 mm
Housing material	Plastic
Plastic housing	PC-ABS
Lens cover material	Plastic / PMMA
Net weight	15 g
Housing color	Red
Type of fastening	Through-hole mounting Via optional mounting device

Operation and display

Type of display	LED
Operational controls	Teach button
Function of the operational control	Light/dark switching Range adjustment

Environmental data

Ambient temperature, operation	-30 ... 50 °C
Ambient temperature, storage	-40 ... 60 °C

Technical data

Certifications

Degree of protection	IP 66
	IP 67
Protection class	III
Certifications	c UL US
Standards applied	IEC 60947-5-2

Classification

Customs tariff number	85365019
ECLASS 5.1.4	27270904
ECLASS 8.0	27270904
ECLASS 9.0	27270904
ECLASS 10.0	27270904
ECLASS 11.0	27270904
ECLASS 12.0	27270903
ECLASS 13.0	27270903
ETIM 5.0	EC002719
ETIM 6.0	EC002719
ETIM 7.0	EC002719
ETIM 8.0	EC002719

Dimensioned drawings

All dimensions in millimeters

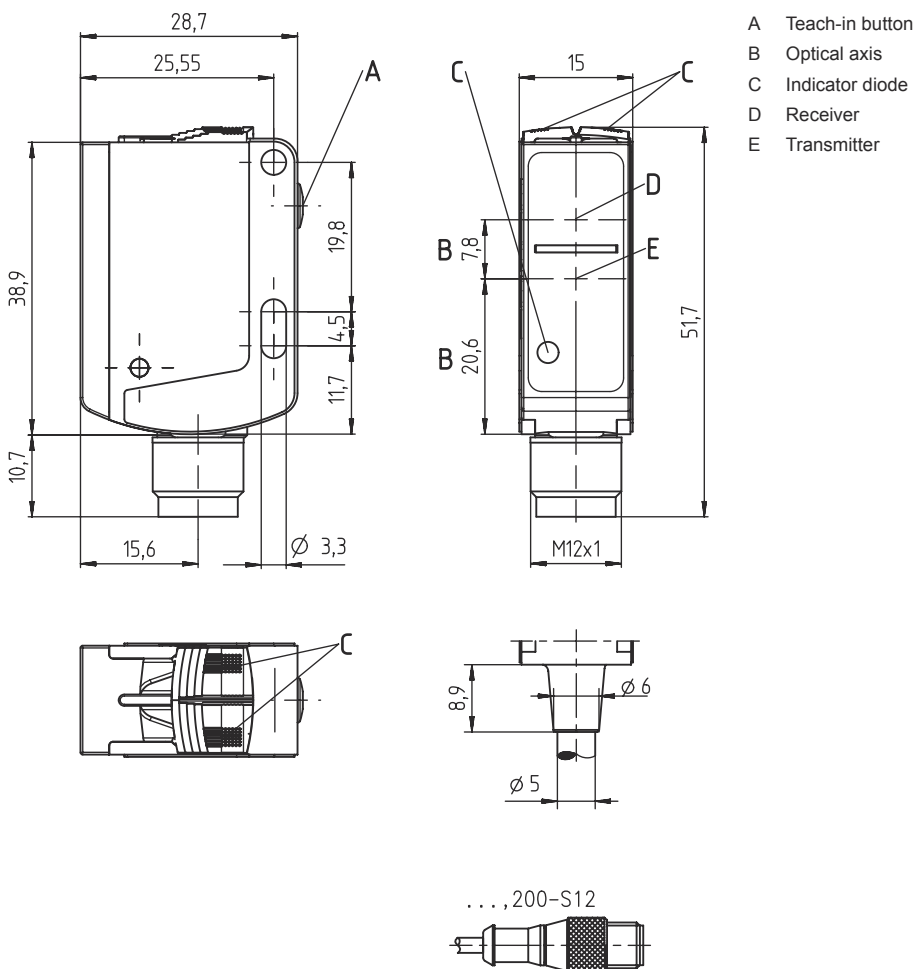

Electrical connection

Connection 1

Function	Signal OUT
	Voltage supply
Type of connection	Connector
Thread size	M12
Type	Male
Material	Plastic
No. of pins	5 -pin
Encoding	A-coded

Pin	Pin assignment
1	V+
2	OUT 2
3	GND
4	IO-Link / OUT 1
5	n.c.

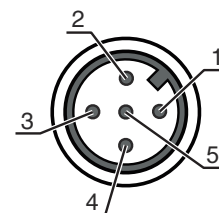

Diagrams

Typ. black/white behavior

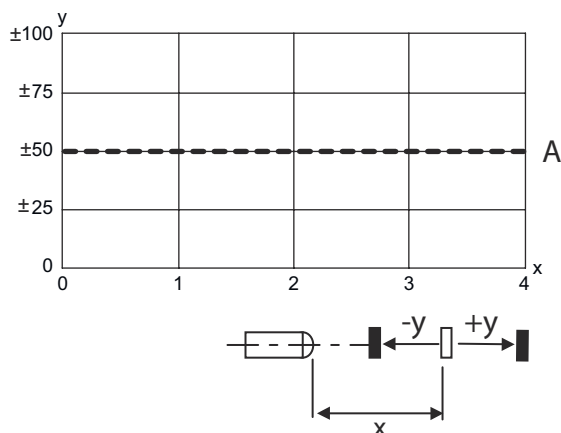

- x Operating range [m]
- y Typ. range change [mm], reference: white 90%
- A 4 ... 90% diffuse reflectance

Operation and display

LED	Display	Meaning
1	Yellow, continuous light	Object detected (switching output Q1)
2	Yellow, continuous light	Object detected (switching output Q2)
	Green, continuous light	Operational readiness
3	Orange, continuous light (behind lens cover)	Object detected (switching output Q1)
	Blue, continuous light (behind lens cover)	Object detected (switching output Q2)
	White, continuous light (behind lens cover)	Object detected (switching output Q1 and Q2)

Notes



Observe intended use!



- ⚠ This product is not a safety sensor and is not intended as personnel protection.
- ⚠ The product may only be put into operation by competent persons.
- ⚠ Only use the product in accordance with its intended use.

For UL applications:



- ⚠ For UL applications, use is only permitted in Class 2 circuits in accordance with the NEC (National Electric Code).
- ⚠ These proximity switches shall be used with UL Listed Cable assemblies rated 30V, 0.5A min, in the field installation, or equivalent (categories: CYJV/ CYJV7 or PVVA/PVVA7)

Further information



- Light source: Average life expectancy 100,000 h at an ambient temperature of 25 °C
- Sum of the output currents for both outputs, 50 mA for ambient temperatures > 40 °C

Accessories



Connection technology - Connection unit

	Part no.	Designation	Article	Description
	50144900	MD 798i-11-82/L5-2222	Distribution box	Type: IO-Link master Current consumption, max.: 11,000 mA Switching outputs for each sensor connection: 1 Piece(s) Switching output: Transistor, PNP Interface: IO-Link, Automatic protocol detection, EtherNet IP, Modbus TCP, PROFINET Connections: 12 Piece(s) Sensor connections: 8 Piece(s) Connections for voltage supply: 2 Piece(s) Interface connections: 2 Piece(s) Degree of protection: IP 67, IP 65, IP 69K

Connection technology - Connection cables



	Part no.	Designation	Article	Description
	50130652	KD U-M12-4A-V1-050	Connection cable	Connection 1: Connector, M12, Axial, Female, A-coded, 4 -pin Connector, LED: No Connection 2: Open end Shielded: No Cable length: 5.000 mm Sheathing material: PVC
	50130690	KD U-M12-4W-V1-050	Connection cable	Connection 1: Connector, M12, Angled, Female, A-coded, 4 -pin Connector, LED: No Connection 2: Open end Shielded: No Cable length: 5.000 mm Sheathing material: PVC

Mounting technology - Mounting brackets

	Part no.	Designation	Article	Description
	50124651	BT 205M-10SET	Mounting device set	Design of mounting device: Angle, L-shape Fastening, at system: Through-hole mounting Mounting bracket, at device: Screw type Type of mounting device: Rigid Material: Metal
	50040269	BT 25	Mounting device	Design of mounting device: Angle, L-shape Fastening, at system: Through-hole mounting Mounting bracket, at device: Screw type Type of mounting device: Rigid Material: Metal

Accessories

Mounting technology - Rod mounts

	Part no.	Designation	Article	Description
	50117829	BTP 200M-D12	Mounting system	Design of mounting device: Protection hood Fastening, at system: For 12 mm rod Mounting bracket, at device: Screw type Type of mounting device: Clampable, Adjustable, Turning, 360° Material: Metal
	50117255	BTU 200M-D12	Mounting system	Design of mounting device: Mounting system Fastening, at system: For 12 mm rod, Sheet-metal mounting Mounting bracket, at device: Screw type, Suited for M3 screws Type of mounting device: Clampable, Adjustable, Turning, 360° Material: Metal

Note



A list with all available accessories can be found on the Leuze website in the Download tab of the article detailed page.