

## DIN 72 × 72 mm Multifunction Counter with a Bright, Easy-to-view, Negative Transmissive LCD.



- Highly visible display with backlit transmissive LCD.
- Selectable display color (red/green) enables checking output status at a distance.
- Easy operation with a key for each digit.
- Perform all basic settings with a DIP switch.
- Provides a total and preset counter, batch counter, dual counter, twin counter, and tachometer (See note.).
- Equipped with a Replacement Time Notification Function to be notified in advance by predicting the service life.
- Equipped with a Memory Backup and H7AN Compatibility Function to facilitate problem-free conversion from H7AN.
- Wide range of inputs accepted for NPN/PNP inputs (multi-inputs) and 2-wire DC sensors.
- Complies with UL, CSA, and CE marking.
- Degree of protection: IP54 equivalent (front section only).



For the most recent information on models that have been certified for safety standards, refer to your OMRON website.

 Refer to *Safety Precautions* on page 36.

**Note:** The functions that can be selected depend on the model.

## Ordering Information

### List of Models

External power supply	Output type	Supply voltage	1-stage	2-stage
12 VDC	Contact and NPN transistor output	100 to 240 VAC	H7BX-A	H7BX-AW
		24 VAC/12 to 24 VDC	H7BX-AD1	H7BX-AWD1

### Accessories (Order Separately)

Name	Model
Soft Cover	Y92A-72F1
Hard Cover	Y92A-72
Terminal Cover *	Y92A-72T

\* Supplied with the H7BX.

# Specifications

## Ratings

Item	Model	H7BX-A/AD1	H7BX-AW/AWD1
Type		Preset counter	Preset counter/tachometer
Supported configurations		1-stage preset counter, total and preset counter *1 (selectable)	1-stage preset counter, 2-stage preset counter, total and preset counter (*1), batch counter, dual counter, twin counter, tachometer (selectable)
Ratings	Power supply voltage *2	H7BX-A/AW: 100 to 240 VAC (50/60 Hz) H7BX-AD1/AWD1: 24 VAC (50/60 Hz)/12 to 24 VDC (ripple 20% max.)	
	Operating voltage range	85% to 110% of rated supply voltage (90% to 110% at 12 VDC)	
	Power consumption	H7BX-A/AW: 9.6 VA max. (100 to 240 VAC) H7BX-AD1/AWD1: 8 VA max. (24 VAC), 5.3 W max. (12 to 24 VDC)	
Mounting method		Flush mounting	
External connections		Screw terminals	
Degree of protection		IP54 (front section only)	
Input signals		CP1, CP2, reset 1, reset 2, key protection	
Counter	Max. counting speed	30 Hz or 5 kHz (selectable, ON/OFF ratio 1:1), setting for both CP1 and CP2	
	Input modes	Increment (UP), decrement (DOWN), increment/decrement (UP/DOWN A (command input), UP/DOWN B (individual inputs), or UP/DOWN C (quadrature inputs)), UP/DOWN D (command input), UP/DOWN E (individual inputs), UP/DOWN F (quadrature inputs)	
	Output modes	N, F, C, R, K-1, P, Q, A, K-2, D, L	N, F, C, R, K-1, P, Q, A, K-2, D, L, H
	One-shot output time	0.01 to 99.99 s	
	Reset input	External reset (minimum reset input signal width: 1 ms or 20 ms selectable), manual reset, and automatic reset (internal according to C, R, P, and Q mode operation)	
Tachometer	Pulse measurement method	---	Periodic measurement (Sampling period: 200 ms)
	Max. counting speed	---	30 Hz or 10 kHz (selectable)
	Measuring ranges	---	30 Hz: 0.01 to 30.00 Hz 10 kHz: 1-input mode: 0.001 to 10 kHz Other modes: 0.01 to 5 kHz
	Measuring accuracy	---	±0.1% FS ±1 digit max. (at 23 ±5°C)
	Output modes	---	Input mode: Not 2-input independent measurement: Upper and lower limits, area, upper limit, lower limit. 2-input independent measurement: Upper limit, lower limit
	Auto-zero time	---	0.1 to 999.9 s
	Startup time	---	0.0 to 99.9 s
Average processing	---	OFF/2/4/8/16 times	
Prescaling function		Yes (0.001 to 99.999)	
Decimal point adjustment		Yes (rightmost 3 digits)	
Sensor waiting time		290 ms max. (Control output is turned OFF and no input is accepted during sensor waiting time.)	
Key protection input		Response speed: Approx. 1 s No-voltage NPN input (fixed) Short-circuit (ON) impedance: 1 kΩ max. (Leakage current at 0 Ω: Approx. 12 mA) Short-circuit (ON) residual voltage: 3 V max. Open (OFF) impedance: 100 kΩ min.	
Input method (except key protection input)		No-voltage NPN input or voltage PNP input (selectable) No-voltage input Short-circuit (ON) impedance: 1 kΩ max. (Leakage current at 0 Ω: Approx. 12 mA) Short-circuit (ON) residual voltage: 3 V max. Open (OFF) impedance: 100 kΩ min. Voltage input High level: 4.5 to 30 VDC Low level: 0 to 2 VDC Input resistance: Approx. 4.7 kΩ	
External power supply		12 VDC (±10%), 100 mA (For details, refer to <i>External Power Supply</i> on page 37.)	
Control output		Contact output: 3 A at 250 VDC/30 VDC, resistive load (cosφ = 1) Minimum applied load: 10 mA at 5 VDC (Failure level: P, reference value) Transistor output: 100 mA max. at 30 VDC max. Residual voltage: 1.5 VDC max. (approx. 1 V) Leakage current: 0.1 mA max.	
Display *3		Backlit 7-segment negative transmissive LCD Character Heights PV: 13.5 mm (red/green) SV: 9 mm (green)	
Digits		6 digits -99,999 to 999,999 (5 digits negative and 6 digits positive)	6 digits Counter: -99,999 to 999,999 (5 digits negative and 6 digits positive) Tachometer: 0 to 999,999 (6 digits)
Memory backup		Non-volatile memory (Overwrites: 100,000 min.), Data storage: 10 years min.	
Ambient operating temperature		-10 to 55°C (with no icing)	
Ambient storage temperature		-25 to 65°C (with no icing)	
Ambient operating humidity		25 to 85°C (with no condensation)	
Case color		Black (N1.5)	
Accessories		Two flush-mounting adapters, terminal cover	Two flush-mounting adapters, terminal cover, DIP switch setting stickers

\*1. The total and preset counter functions as a 1-stage preset counter and total counter.

\*2. Do not use an inverter output for the power supply.

\*3. Displayed only when the power is ON. Not displayed when the power is OFF.

## Characteristics

<b>Insulation resistance</b>	100 MΩ min. (at 500 VDC) between current-carrying terminal and exposed non-current-carrying metal parts, and between non-continuous contacts
<b>Dielectric strength</b>	Between current-carrying metal parts and non-current-carrying metal parts: 2,000 VAC, 50/60 Hz for 1 min Between power supply and input circuit: 2,000 VAC, 50/60 Hz for 1 min (for models other than the H7BX-A□D1) 1,000 VAC, 50/60 Hz for 1 min (H7BX-A□D1) Between control output, power supply, and input circuit: 2,000 VAC, 50/60 Hz for 1 min Between non-continuous contacts: 1,000 VAC, 50/60 Hz for 1 min
<b>Impulse withstand voltage</b>	6.0 kV between power terminals: 3.0 kV (1.0 kV for 24 VAC/12 to 24 VDC models) 6.0 kV between current-carrying terminal and exposed non-current-carrying metal parts: 4.5 kV (1.5 kV for 24 VAC/12 to 24 VDC models)
<b>Noise immunity</b>	Between power terminals: ±1.5 kV Between input terminals: ±600 V Square-wave noise by noise simulator (Pulse width: 100 ns/1 μs, 1-ns rise)
<b>Static immunity</b>	Malfunction: 8 kV Destruction: 15 kV
<b>Vibration resistance</b>	Destruction: 10 to 55 Hz, 0.75-mm single amplitude, 2 hours each in three directions Malfunction: 10 to 55 Hz, 0.50-mm single amplitude, 10 minutes each in three directions
<b>Shock resistance</b>	Destruction: 294 m/s <sup>2</sup> 3 times each in 6 directions Malfunction: 98 m/s <sup>2</sup> 3 times each in 6 directions
<b>Life expectancy</b>	Mechanical: 10,000,000 operations min. Electrical: 100,000 operations min. (3 A at 250 VAC/30 VDC, resistive load) *
<b>Weight</b>	Approx. 250 g

\* Check the electrical life expectancy curve.

## Applicable Standards

<b>Approved safety standards</b>	cURus: UL 508, CSA C22.2 No. 14 EN 61010-1 (IEC 61010-1): Pollution degree 2/overvoltage category II; EN 61326; VDE 0106 Part 100	
<b>EMC</b>	(EMI) Emission Enclosure: Emission AC mains: (EMS) Immunity ESD: Immunity RF-interference: Immunity Conducted Disturbance: Immunity Burst: Immunity Surge: Immunity Voltage Dip/Interruption:	EN 61326-1 * EN 55011 Group 1 class A EN 55011 Group 1 class A EN 61326-1 * EN 61000-4-2: 4 kV contact discharge; 8 kV air discharge EN 61000-4-3: 10 V/m (Amplitude-modulated, 80 MHz to 1 GHz); 10 V/m (Pulse-modulated, 900 MHz ±5 MHz) EN 61000-4-6: 3 V (0.15 to 80 MHz) EN 61000-4-4: 2 kV power-line; 1 kV I/O signal-line EN 61000-4-5: 1 kV line to lines (power and output lines (relay outputs)); 2 kV line to ground (power and output lines (relay outputs)) EN 61000-4-11: Voltage Dip 1 cycle, 100% (rated voltage) 10/12 cycle 60% (rated voltage) 25/30 cycle 30% (rated voltage) Interruption 250/300 cycle 100% (rated voltage)

\* Industrial electromagnetic environment (EN/IEC 61326-1 Table 2)

## Electrical Life Expectancy (Reference Values)

### Resistive Load

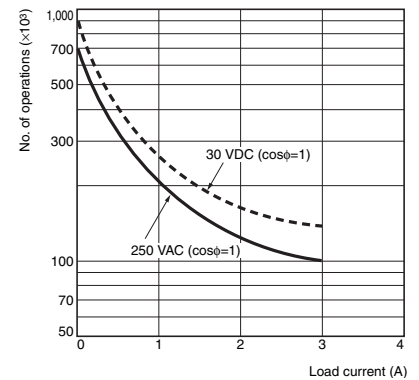

### Inductive Load

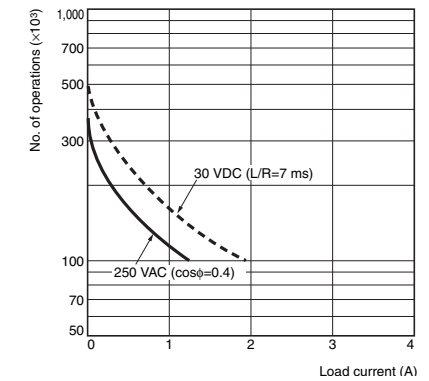

A current of 0.15 A max. can be switched at 125 VDC (cosφ = 1) and current of 0.1 A max. can be switched with L/R = 7 m/s. In both cases, a life of 100,000 operations can be expected.

## I/O Functions

### Using as a Counter \*1

Inputs	CP1, CP2	(1) All Modes Except for Dual Counter Mode and Twin Counter Mode <ul style="list-style-type: none"> <li>• Reads count signals.</li> <li>• Increment, decrement, up/down (command, individual, or quadrature) inputs can be used.</li> </ul> (2) Dual Counter Mode or Twin Counter Mode <ul style="list-style-type: none"> <li>• Reads CP1 count signals on CP1 input and CP2 count signals on CP2 input.</li> <li>• Increment signals can be used.</li> </ul>
	Reset or Reset 1	(1) All Modes Except for Dual Counter Mode and Twin Counter Mode <ul style="list-style-type: none"> <li>• Resets present value and outputs (OUT2 when using the batch counter). *2</li> <li>• Counting cannot be performed while resetting or when reset 1 input is ON.</li> <li>• The reset indicator is lit while the reset input is ON.</li> </ul> (2) Dual Counter Mode or Twin Counter Mode <ul style="list-style-type: none"> <li>• Resets the CP1 present value to 0.</li> <li>• Counting the CP1 input cannot be performed while the reset 1 input is ON.</li> <li>• The reset indicator is lit while the reset 1 input is ON.</li> </ul>
	Total Reset or Reset 2	The reset operation depends on the selected function. *3
Outputs	OUT1, 2	When the corresponding set value is reached, signals are output according to the designated output mode.

\*1. Refer to pages 18 to 23 for information on the operation of input and output functions.

\*2. In increment mode or increment/decrement mode, the present value returns to 0; in decrement mode, the present value returns to the set value with 1-stage models, and returns to set value 2 with 2-stage models.

\*3. The reset indicator will not be lit when the total reset or reset 2 input is ON.

Function	Reset operation
1-stage/2-stage preset counter	Does not operate (Not used).
Total and preset counter	<ul style="list-style-type: none"> <li>• Resets the total count value.</li> <li>• Holds the total count value at 0 while the total reset input is ON.</li> </ul>
Batch counter	<ul style="list-style-type: none"> <li>• Resets the batch count value and batch output (OUT1).</li> <li>• Holds the batch count value at 0 while the reset 2 input is ON.</li> </ul>
Dual counter	<ul style="list-style-type: none"> <li>• Resets the CP2 present value.</li> <li>• Counting for CP2 input is disabled while the reset 2 input is ON.</li> </ul>
Twin counter	<ul style="list-style-type: none"> <li>• Resets the CP1 present value and output 1 when the CP1 present value is displayed.</li> <li>• Resets the CP2 present value and output 2 when the CP2 present value is displayed.</li> </ul>

### Using as a Tachometer

Inputs	CP1, CP2	Reads counting signals. (The CP2 input can be used when the input mode is not 1-input mode.)
	Reset 1, Reset 2	<ul style="list-style-type: none"> <li>• Holds the measurement value and outputs. (The reset 2 input can be used when the input mode is 2-input independent measurement.)</li> <li>• Functions as a hold input. The measurement value (displayed value) and the outputs are held while the RST Key on the front panel is pressed.</li> <li>• The reset indicator is lit when the value is being held.</li> </ul>
Outputs	OUT1, OUT2	Outputs signals according to the specified output mode when a set value is reached.

### Using as a Counter or Tachometer

Key protection input	<ul style="list-style-type: none"> <li>• Prohibits using the keys on the front panel.</li> <li>• Set the key protection level in function selection mode.</li> <li>• Key protection is enable by short-circuited key protection terminals.</li> </ul>
----------------------	---

**Note:** For details, refer to page 34.

# Connections

## Terminal Arrangement

Confirm that the power supply meets specifications before using the H7BX.

### H7BX-A

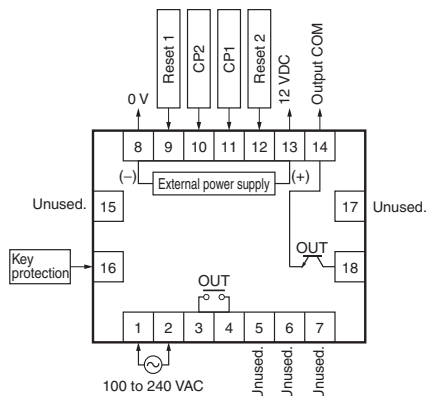

### H7BX-AW

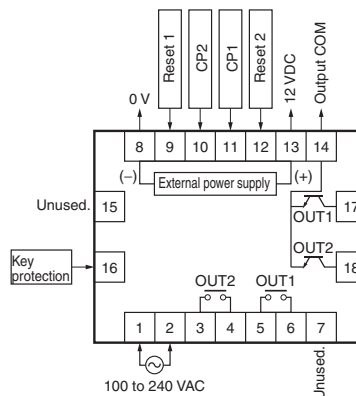

### H7BX-AD1

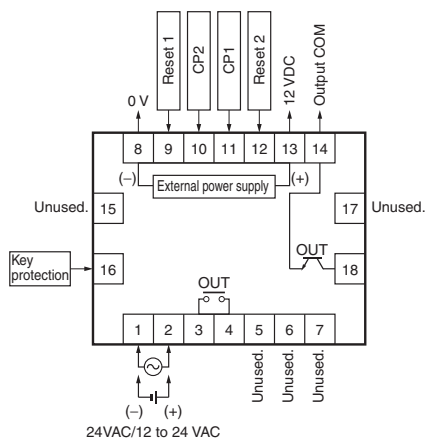

### H7BX-AWD1

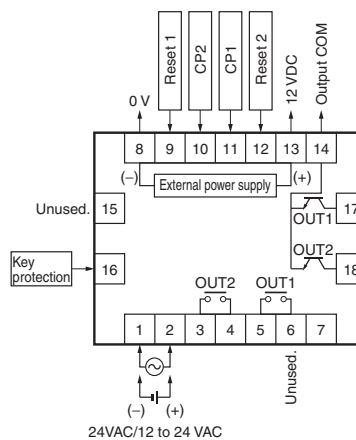

**Note:** Do not use the unused terminals for relay connections.

## Block Diagram

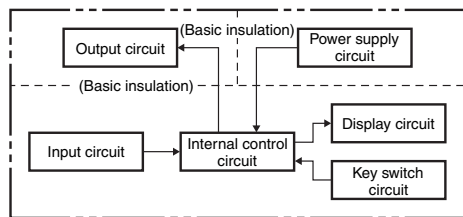

## Input Circuits

### CP1, CP2, Reset/Reset 1, and Total Reset/Reset 2 Input

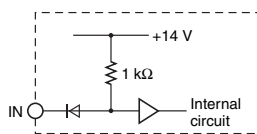

**Note:** The circuit shown above is for no-voltage input (NPN input).

## Input Connections

A no-voltage input (short-circuit or open) or voltage input can be selected for each input. (The key protection input is always a no-voltage input (NPN input)).

### No-voltage Inputs (NPN Inputs)

#### Open Collector

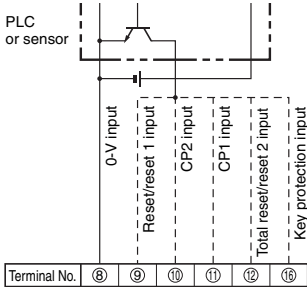

Operates when the transistor turns ON.

#### Voltage Output

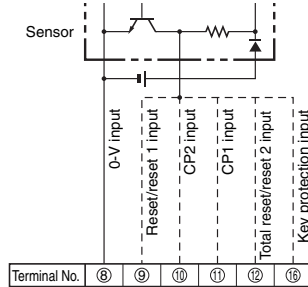

Operates when the transistor turns ON.

#### Contact Input

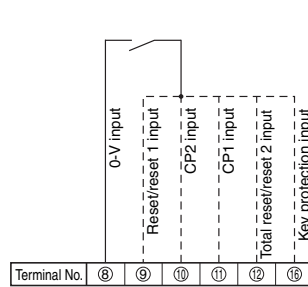

Operates when the contact turns ON.

#### DC Two-wire Sensor

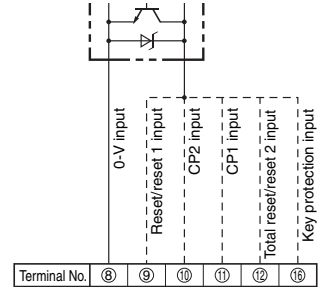

Operates when the transistor turns ON.

**Note:** When using the H7BX as a tachometer, do not use the CP2 input or total reset/reset 2 input.

### No-voltage Input Signal Levels

<b>No-contact input</b>	Short-circuit level Transistor ON
	<ul style="list-style-type: none"> <li>Residual voltage: 3 V max.</li> <li>Impedance when ON: 1 kΩ max.</li> </ul> (The leakage current is approx. 12 mA when the impedance is 0 Ω.)
<b>Contact input</b>	Open level Transistor OFF
	<ul style="list-style-type: none"> <li>Impedance when OFF: 100 kΩ min.</li> </ul>

Applicable Two-wire Sensors
<ul style="list-style-type: none"> <li>Leakage current: 1.5 mA max.</li> <li>Switching capacity: 5 mA min.</li> <li>Residual voltage: 3 VDC max.</li> <li>Operating voltage: 10 VDC</li> </ul>

**Note:** Use a DC power supply of 30 V max.

### Voltage Inputs (PNP Inputs)

#### No-contact Input (NPN Transistor)

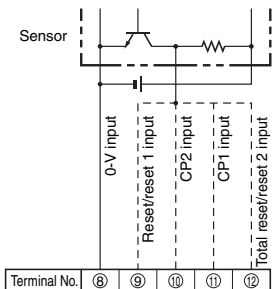

Operates when the transistor turns OFF.

#### No-contact Input (PNP Transistor)

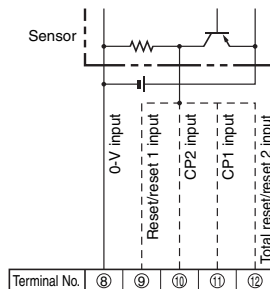

Operates when the transistor turns ON.

#### Contact Input

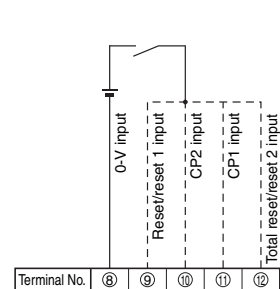

Operates when the contact turns ON.

**Note:** When using the H7BX as a tachometer, do not use the CP2 input or total reset/reset 2 input.

### Voltage Input Signal Levels

High level (Input ON): 4.5 to 30 VDC
Low level (Input OFF): 0 to 2 VDC

**Note:** 1. Use a DC power supply of 30 V max.  
2. Input resistance: Approx. 4.7 kΩ

# Nomenclature

Indicators	
1	Reset Indicator (Orange) Lit when the reset input (1) or reset key is ON.
2	Key Protection Indicator (Orange)
3	Control Output Indicator (Orange) OUT: One stage OUT1, OUT2: Two stages
4	Present Value (Main Display) Character height: 13.5 mm (Red/green selectable)
5	Set Value (Sub-display) Character height: 9 mm (Green)
6	Set Value 1 and 2 Stage Indicators (Green)
7	Total Count Indicator (Green) Lit when the total count value is displayed.
8	Batch Indicator (Green) Lit when the batch count value is displayed.

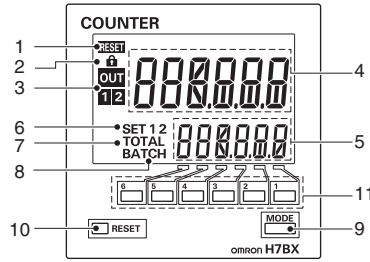

Operation Keys	
9	Mode Key Used to switch mode and setting items.
10	Reset Key
11	Up Keys: [1] to [6]

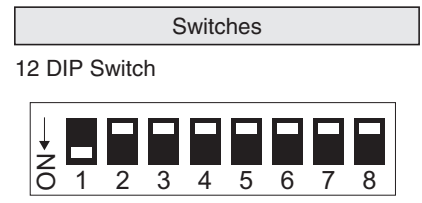
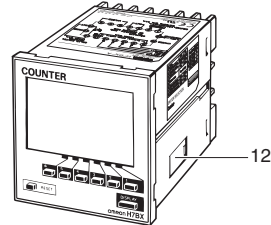

# Dimensions

(Unit: mm)

## Counter

Counter  
H7BX-A□□

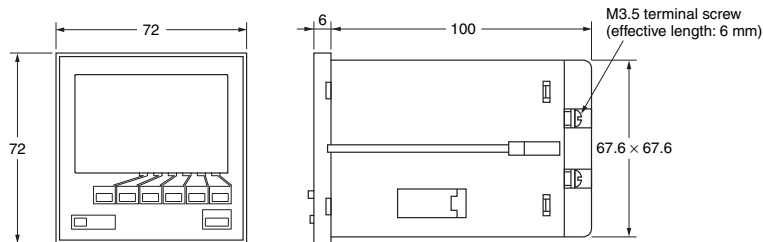
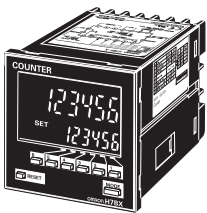

**Note:** M3.5 terminal screws (effective length: 6 mm).

## Dimensions with Flush Mounting Adapter

H7BX-A□□  
(The flush mounting adapter is supplied with the H7BX.)

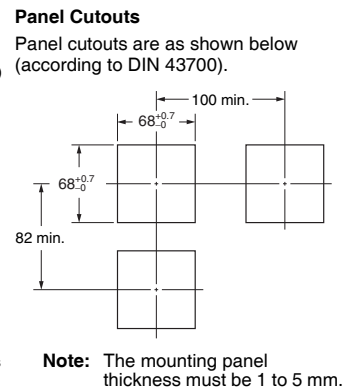
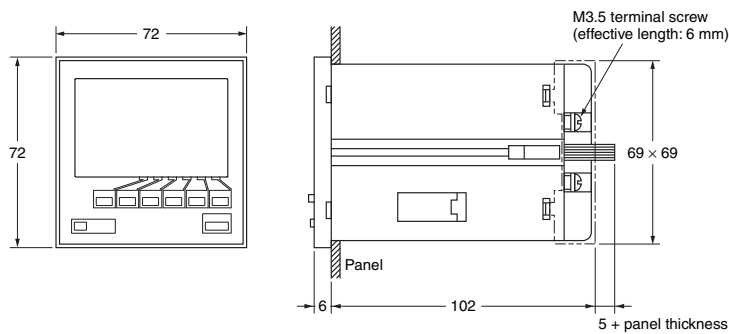
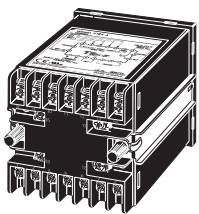

## Accessories (Order Separately)

Soft Cover  
Y92A-72F1

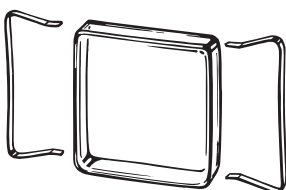

**Note:** Depending on the operating environment, the condition of resin parts may deteriorate, and may shrink or harden. Therefore, it is recommended that resin parts are replaced regularly.

**Product Protection for Use in Environments Subject to Water or Oil**  
The panel surface has a protective structure so that the internal circuits will not be adversely affected if drops of water penetrate the gaps between the keys. If, however, there is a possibility of water or oil being present on the operator's hands, mount the optional Soft Cover. The Soft Cover ensures protection equivalent to IP54. Do not, however, use the H7BX in locations where it would come into direct contact with oil.

Hard Cover  
Y92A-72

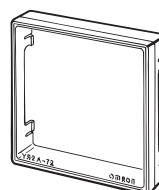

Terminal Cover \*  
Y92A-72T  
(VDE0106/T100)

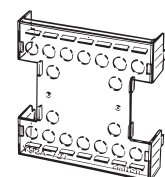

\* Supplied with the H7BX.

## Operating Procedures

### Setting Procedure Guide Settings for Counter Operation

(1-stage/2-stage Counter, Total and Preset Counter, Batch Counter, Dual Counter, Twin Counter)

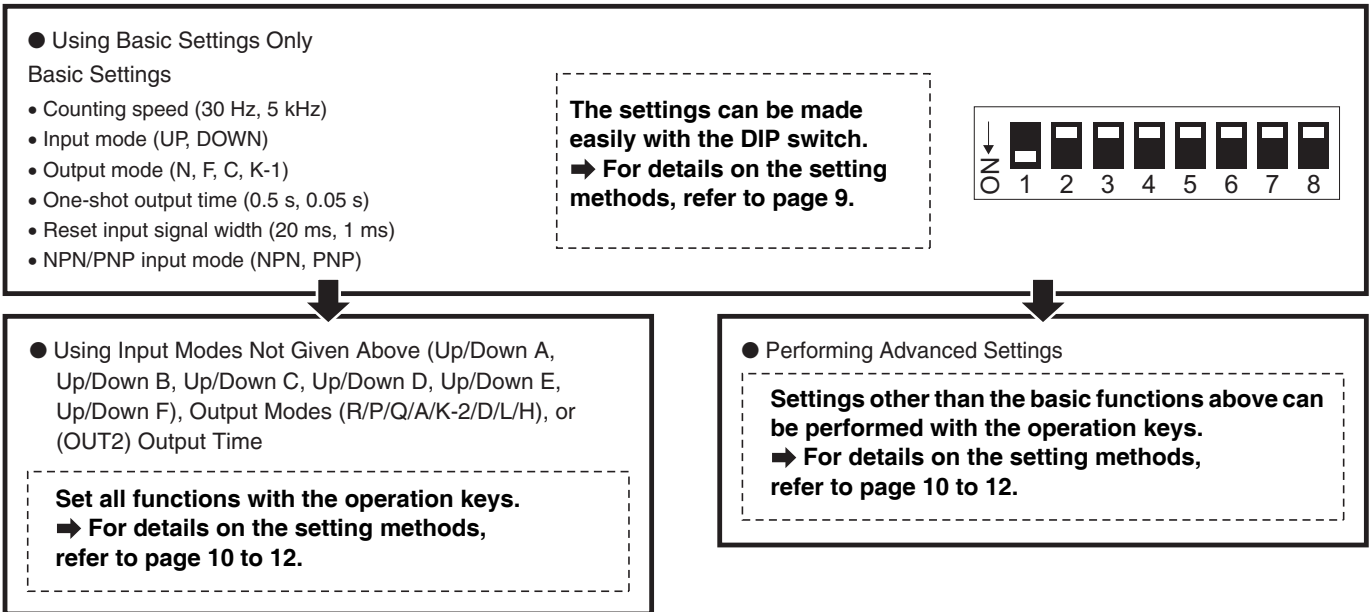

**Note:** The default setting is for a 1-stage preset counter. (For models with a 2-stage setting, the default is a 2-stage preset counter.)

### Setting for Tachometer Operation (H7BX-AW□ only)

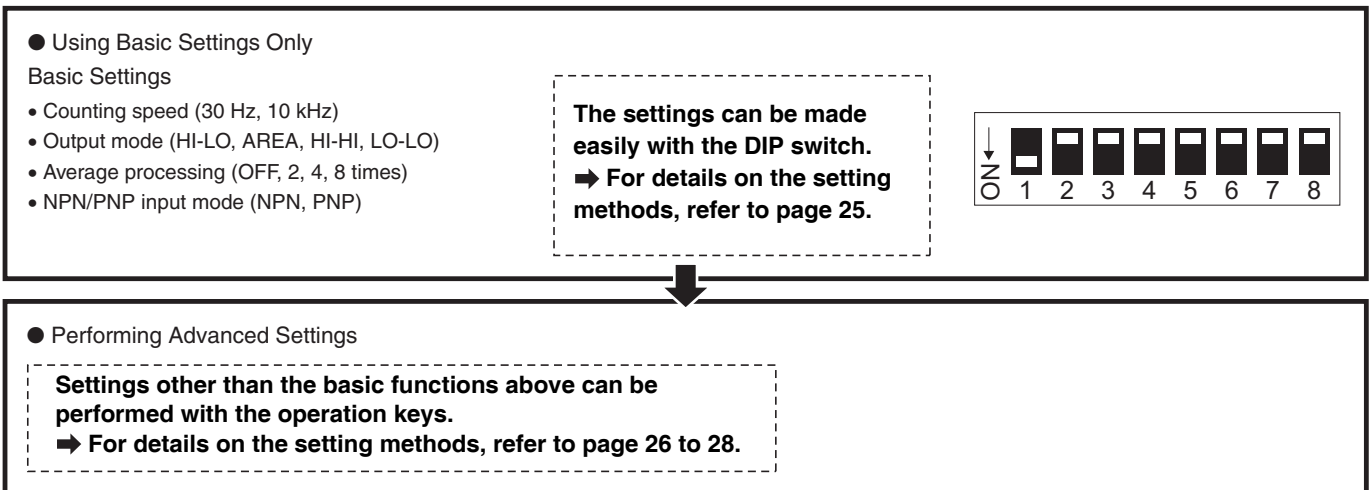

**Note:** The default setting is for a 2-stage preset counter.



Operating Procedures (Counter Function)

Settings for Basic Operations

Settings for basic functions can be performed with just the DIP switch.

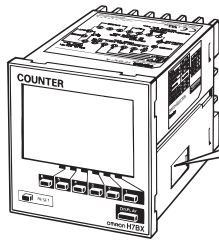

Be sure to turn ON pin 1 when using the DIP switch.



Item	OFF	ON	
1	DIP switch settings enable/disable	Disabled	Enabled
2	Counting speed	30 Hz	5 kHz
3	Input mode	UP (increment)	DOWN (decrement)
4	Output mode	Refer to the table on the right.	
5			
6	One-shot output time (See note.)	0.5 s	0.05 s
7	Reset input signal width	20 ms	1 ms
8	NPN/PNP input mode	NPN (no-voltage)	PNP (voltage)

Pin 4	Pin 5	Output mode
OFF	OFF	N
ON	OFF	F
OFF	ON	C
ON	ON	K-1

Note: All the pins are factory-set to OFF.

The ON/OFF status of the DIP switch pins can be confirmed using the front display. For details, refer to page 33.

Convenient Function

Caution

- Always turn OFF the power supply before changing the DIP switch settings.
- Always turn ON pin 1 when performing settings with the DIP switch. Performing settings with the DIP switch is disabled when pin 1 is OFF.
- DIP switch setting changes will be updated when the power is turned ON. Perform the settings before performing installation and supplying power.
- Properly set the DIP switch to match the item being counted (or measured) and use the DIP switch monitor for confirmation.
- Use the keys on the front panel to perform all settings for input modes, output modes, and output times that cannot be set with the DIP switch. For details on the setting methods, refer to page 10 to 12. When performing these settings, always turn OFF pin 1 (DIP switch setting) (disabled).

Using the H7BX as a Total and Preset Counter, Batch Counter, Dual Counter, or Twin Counter

The default setting is for a 1-stage preset counter. (For models with a 2-stage setting, the default is for a 2-stage preset counter.) To make changes, use the procedure shown on the right. For details, refer to page 33.

Hold down the **MODE** Key and press the **Up1** Key for at least 1 s.  
The mode will not change if the **Up1** Key is pressed first.

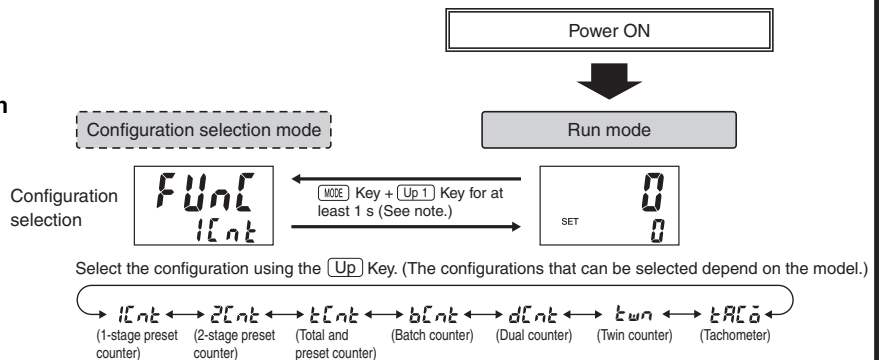

Note: This includes using a model with a 2-stage setting as a 1-stage preset counter.

After setting the DIP switch for basic operations, advanced functions can be added using the operation keys. For details, refer to page 10 to 12.



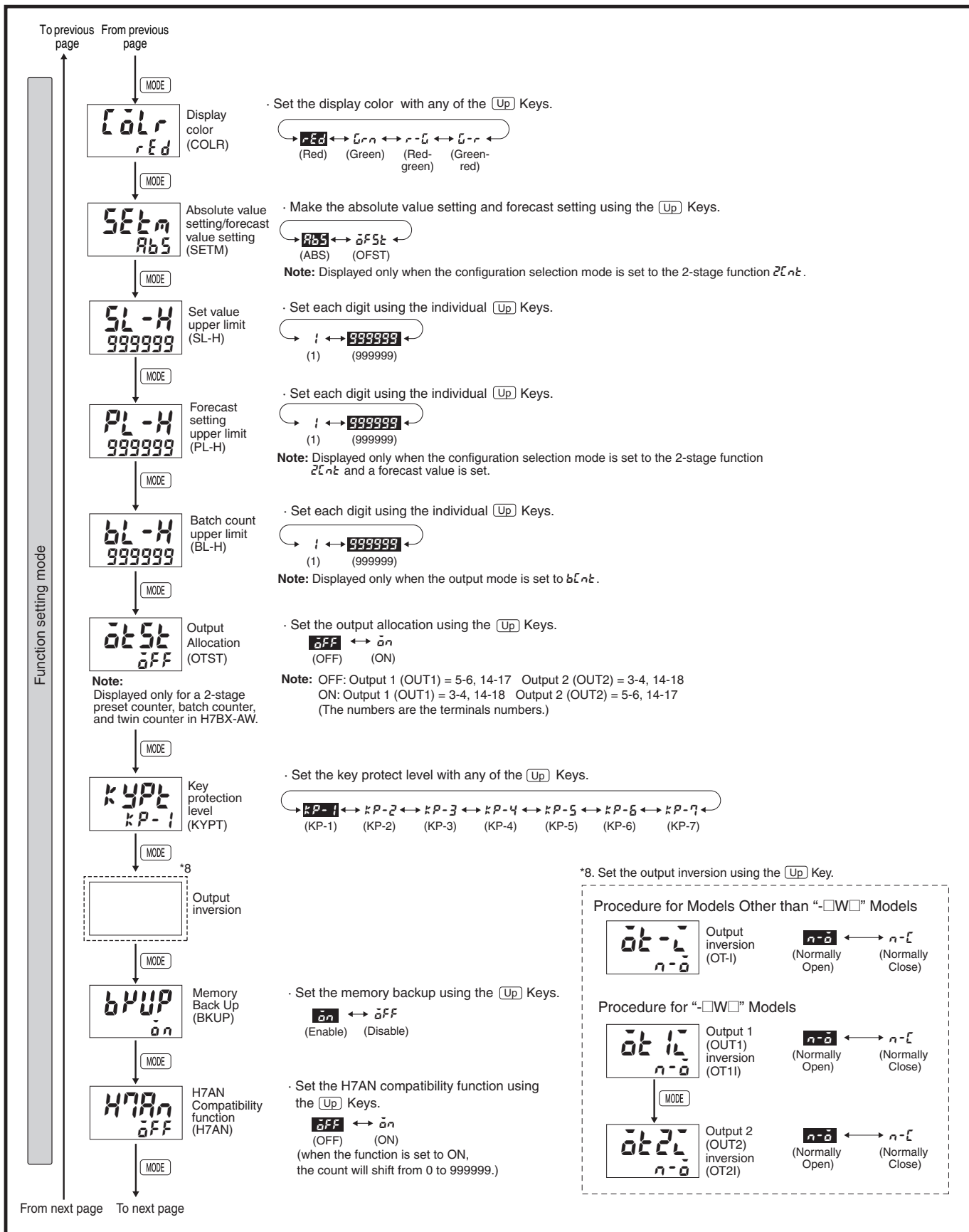

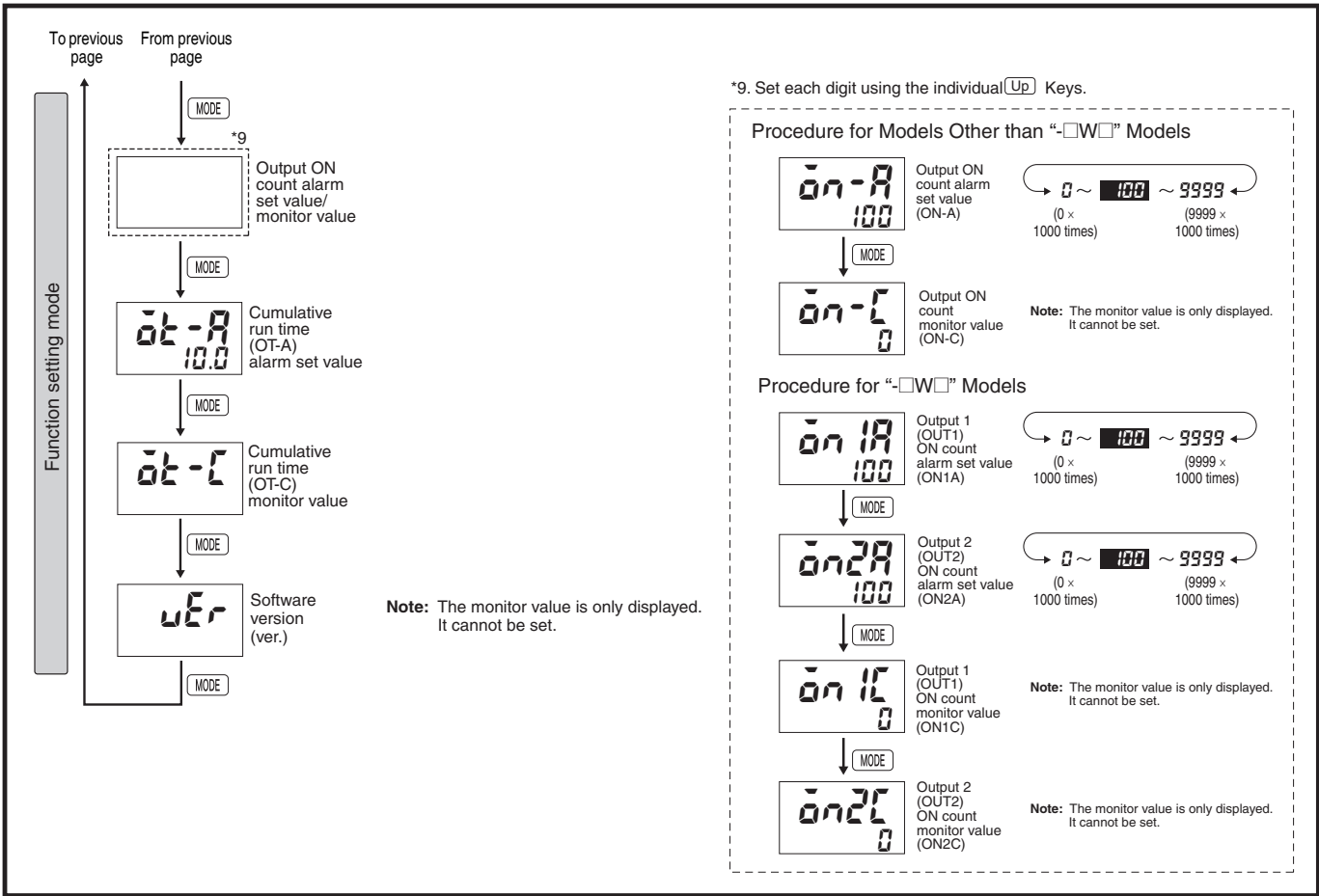

## Explanation of Functions

Settings marked with a star can be performed with the DIP switch.

### • Input Mode (ㄨㄥㄣ) ★

Set increment mode (UP), decrement mode (DOWN), or one of the increment/decrement modes (UP/DOWN A, UP/DOWN B, UP/DOWN C, UP/DOWN D, UP/DOWN E, or UP/DOWN F) as the input mode. Input modes other than UP or DOWN modes cannot be set using the DIP switch. Use the operation keys if other modes are required. (For details on the operation of the input modes, refer to *Input Modes and Present Value* on page 16.)

### • Dual Count Calculating Mode (ㄨㄥㄣ) ★

When the H7BX using as a dual counter, select either ADD (addition) or SUB (subtraction) as the calculation method for the dual count value.

ADD: Dual count value = CP1 PV + CP2 PV

SUB: Dual count value = CP1 PV – CP2 PV

### • Output Mode (ㄨㄥㄣ) ★

Set the way that control output for the present value is output. The possible settings are N, F, C, R, K-1, P, Q, A, K-2, D, L, and H. Output modes other than N, F, C, or K-1 cannot be set using the DIP switch. Use the operation keys if other modes are required. The output modes that can be set with the model. (For details on the operation of the output modes, refer to *Input/Output Mode Settings* on page 18.)

### • One-shot Output Time (ㄨㄥㄣ) ★

Set the one-shot output time (0.01 to 99.99 s) for the control output. A one-shot output can be used only when C, R, K-1, P, Q, A, or K-2 is selected as the output mode. Output times other than 0.5 s or 0.05 s cannot be set with the DIP switch. Use the operation keys if other settings are required.

### • One-shot Output 2 Time (ㄨㄥㄣ) ★

When the H7BX using as a 2-stage counter or batch counter, set the one-shot output time (0.01 to 99.99 s) for control output (OUT2). A one-shot output can be used only when C, R, K-1, P, Q, A, or K-2 is selected as the output mode. Output times other than 0.5 s or 0.05 s cannot be set with the DIP switch. Use the operation keys if other settings are required.

### • One-shot Output 1 Time (ㄨㄥㄣ) ★

When the H7BX using as a 2-stage counter, set the one-shot output time (0.01 to 99.99 s) for control output (OUT1). A one-shot output can be used only when D, L, or H is selected as the output mode. If the output time is set to 0.00, H0.0 is displayed, and outputs are held.

### • Counting Speed (ㄨㄥㄣ) ★

Set the maximum counting speed (30 Hz/5 kHz) for CP1 and CP2 inputs together. If contacts are used for input signals, set the counting speed to 30 Hz. Processing to eliminate chattering is performed for this setting.

### • Reset Input Signal Width (ㄨㄥㄣ) ★

Set the reset input signal width (20 ms/1 ms) for reset/reset 1 and total reset/reset 2 inputs together. If contacts are used for input signals, set the counting speed to 20 ms. Processing to eliminate chattering is performed for this setting.

### • Decimal Point Position (ㄨㄥㄣ) ★

Decide the decimal point position for the present value, CP1/CP2 present values, set values (SV1, SV2), total count value, dual count value and dual count set value.

### • Prescale Value (ㄨㄥㄣ) ★

Pulses input to the counter are converted according to the specified prescale value.

Setting range: 0.001 to 99.999

Example: To display the feed distance for systems that output 25 pulses for a feed length of 0.5 m in the form □□.□□ m:  
 1. Set the decimal point position to 2 decimal places.  
 2. Set the prescale value to 0.02 (0.5 ÷ 25).

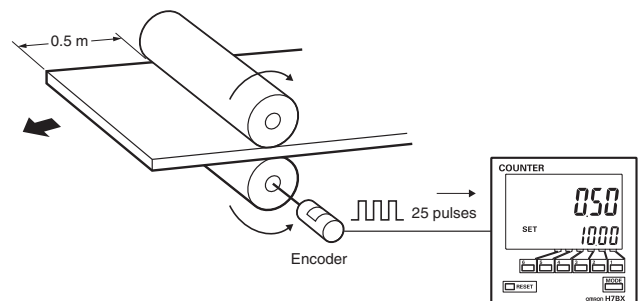

**Note:** Incorrectly setting the prescale value will result in counting errors. Check that the setting has been performed correctly before using the H7BX.

### • NPN/PNP Input Mode (ㄨㄥㄣ) ★

Select either NPN input (no-voltage input) or PNP input (voltage input) as the input format. For 2-wire sensors, set the format to NPN input. The same format setting applies to all external inputs. For information on input connections, refer to page 6.

### • Display Color (ㄨㄥㄣ) ★

Set the color used for the present value.

	Output OFF *	Output ON *
rEd	Red (fixed)	
Grn	Green (fixed)	
r-G	Red	Green
Gr-r	Green	Red

\* When the H7BX using as a 2-stage counter, this is the status of output 2.

• **Absolute Value Setting/Forecast Value Setting (5E5)**

For the 2 count output mode, an absolute value setting (Ab5) or forecast value setting (aF5k) can be set for set value 1. If the absolute value setting is used, specify an absolute value (deviation from 0).

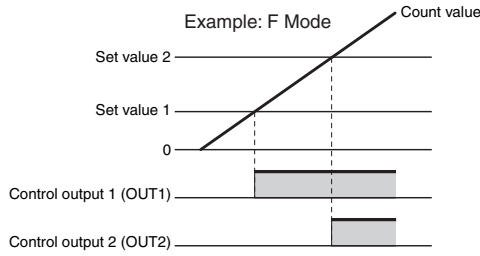

If the forecast value setting is used, specify set value 1 as the forecast set value (deviation with respect to set value 2). The forecast output (output 1) turns ON when the present value reaches the forecast value. If the forecast set value is greater than or equal to the set value, the forecast output (output 1) will turn ON as soon as counting starts.

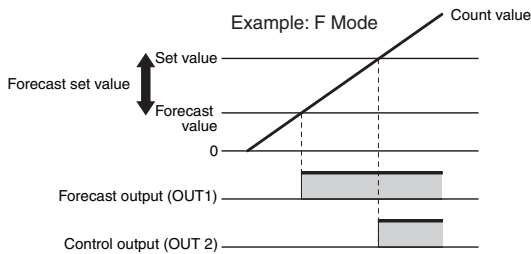

• **Set Value Upper Limit (5L -H)**

Set the upper limit for the set value when it is set in run mode.

• **Forecast Set Upper Limit (FL -H)**

Set the upper limit for the forecast set value.

• **Batch Count Upper Limit (bL -H)**

Set the upper limit for the batch count value.

• **Output Allocation (Settings applicable to only H7BX-AW) (a55k)**

Set the allocation of outputs 1 and 2 (OUT1 and OUT2). If output allocation is OFF, output 1 (OUT1) is allocated to terminals (5)-(6), (14)-(17), and output 2 (OUT2) is allocated to terminals (3)-(4), (14)-(18). If output allocation is ON, output 1 (OUT1) is allocated to terminals (3)-(4), (14)-(18), and output 2 (OUT2) is allocated to terminals (5)-(6), (14)-(17).

• **Key Protect Level (kYPL)**

Set the key protect level. Refer to *Key Protect Level* on page 34.

• **Output inversion (a5 -L, a5 l-L, a5 2-L)**

Set logical inversion of output ON/OFF. In the case of two outputs, it is possible to individually set output inversion for each of output 1 and output 2 (OUT1 and OUT2). If output inversion is n-a (Normally Open), the output turns ON when the set value is reached. If output inversion is n-L (Normally close), the output turns OFF when the set value is reached.

• **Memory back up (bMUP)**

Set the present value and the output state memory backup. If memory backup is available, the present value and output state are recovered to the state prior to power interruption. If memory backup is not available, the present value and output state are recovered to the reset state.

• **H7AN Compatibility Function (H7AN)**

When the present value being decremented exceeds 0, make the setting to start counting from 999999. When this function is ON, the value becomes 999999 after 0, and when this function is OFF, the count is in accordance with the output mode. The H7AN Compatibility Function is enabled only when 1-stage preset counter, 2-stage preset counter, and total and preset counter are selected, and is displayed in the function setting mode. It is not displayed when batch counter, dual counter, or twin counter are selected. This function enables the same operation when the H7AN is replaced with the H7BX.

• **Output ON Count Alarm Set Value (a5-R, a5 lR, a5 2R)**

The output ON count for notifying the replacement time can be set. For details, refer to page 35.

• **Output ON Count Monitor Value (a5-L)**

The monitor value is only displayed. It cannot be set. The output ON count will be 1,000 times the displayed value.

• **ON Count Monitor Values for Outputs 1 and 2 (OUT1 and OUT2) (a5 lL and a5 2L)**

The monitor value for output 1 and 2 (OUT1 and OUT2) is only displayed. It cannot be set. The output ON count will be 1,000 times the displayed value.

• **Cumulative Run Time Alarm Set Value (a5-R)**

The cumulative run time for notifying the replacement time can be set. For details, refer to page 35.

• **Cumulative Run Time Monitor (a5-L)**

The cumulative run time is displayed. It is not a setting item. The numerical values are displayed in increments of 0.1 years.

## Operation in Run Mode I/O Functions for Counter Operation

- Set values for each digit as required using the **Up** Keys.

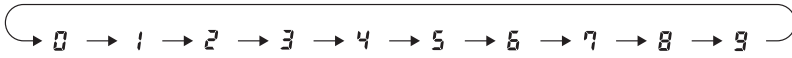

### 1-stage Preset Counter

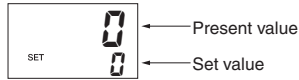

### 2-stage Preset Counter with Absolute Value Setting

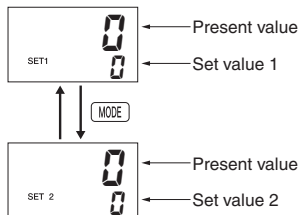

- Present Value**  
Shows the present count value.
- Set Values (Set Value 1 and Set Value 2)**  
Set the set values.  
When the present value reaches the set value (set value 1 or set value 2), a signal is output according to the specified output mode.

### 2-stage Preset Counter with Forecast Value Setting

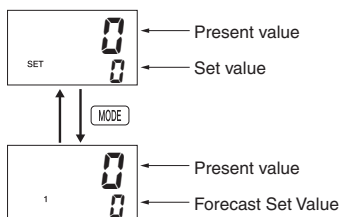

- Present Value**  
Shows the present count value.
- Set Values**  
Set the set values.
- Forecast Set Value**  
Set the deviation for the set value.

### Total and Preset Counter

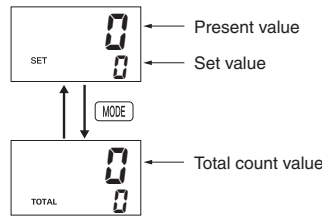

- Present Value/Set Value**  
Same as 1-stage preset counter.
- Total Count Value**  
Shows the present total count value.

### Batch Counter

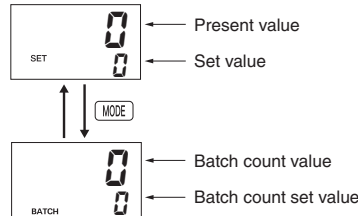

- Present Value/Set Value**  
Same as 1-stage preset counter.
- Batch Count Value**  
Shows the number of times the count has been completed for the present value.
- Batch Count Set Value**  
Set the batch count set value.  
When the batch count value reaches the batch count set value, batch output (OUT1) turns ON.

### Dual Counter

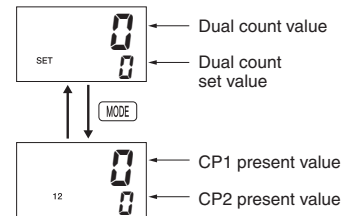

- Dual Count Value**  
Shows the sum of the CP1 present value and CP2 present value when the dual count calculating mode is ADD and shows the value obtained by subtracting the CP2 present value from the CP1 present value when the dual count calculating mode is SUB.
- Dual Count Set Value**  
Set the dual count set value.  
When the dual count value reaches the dual count set value, signals are output according to the specified output mode.
- CP1/CP2 Present Value**  
Show the present count values for CP1 and CP2 present values respectively.

### Twin Counter

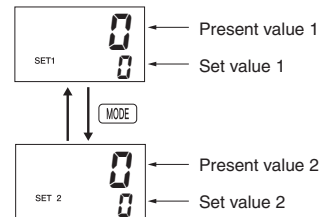

- Present Values 1 and 2**  
Shows the present count value 1 or 2.
- Set Values 1 and 2**  
Setting for present value 1 or 2.

**Input Modes and Present Value** (See note 1.)

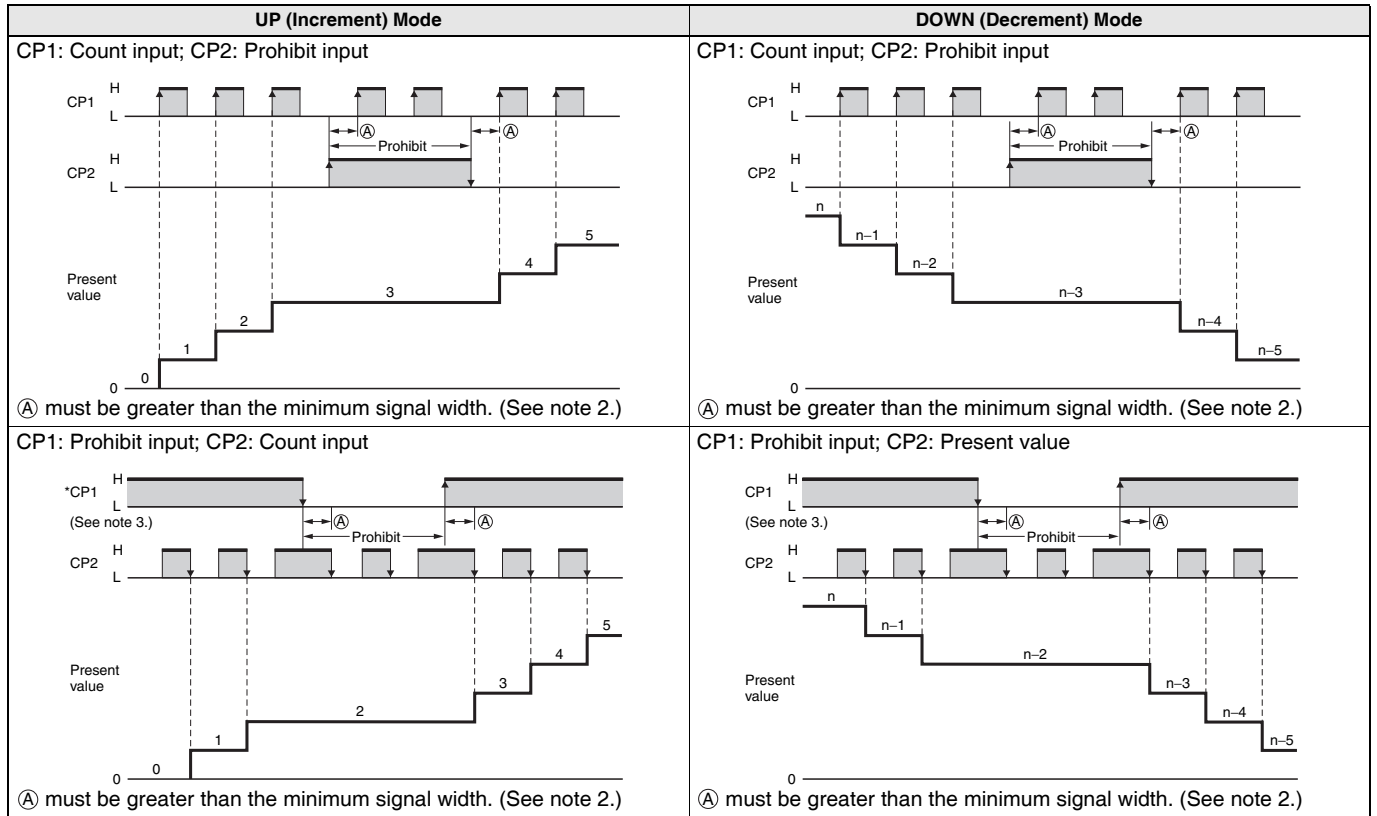

\* If CP1 turns ON after the power is turned ON, it will be counted.



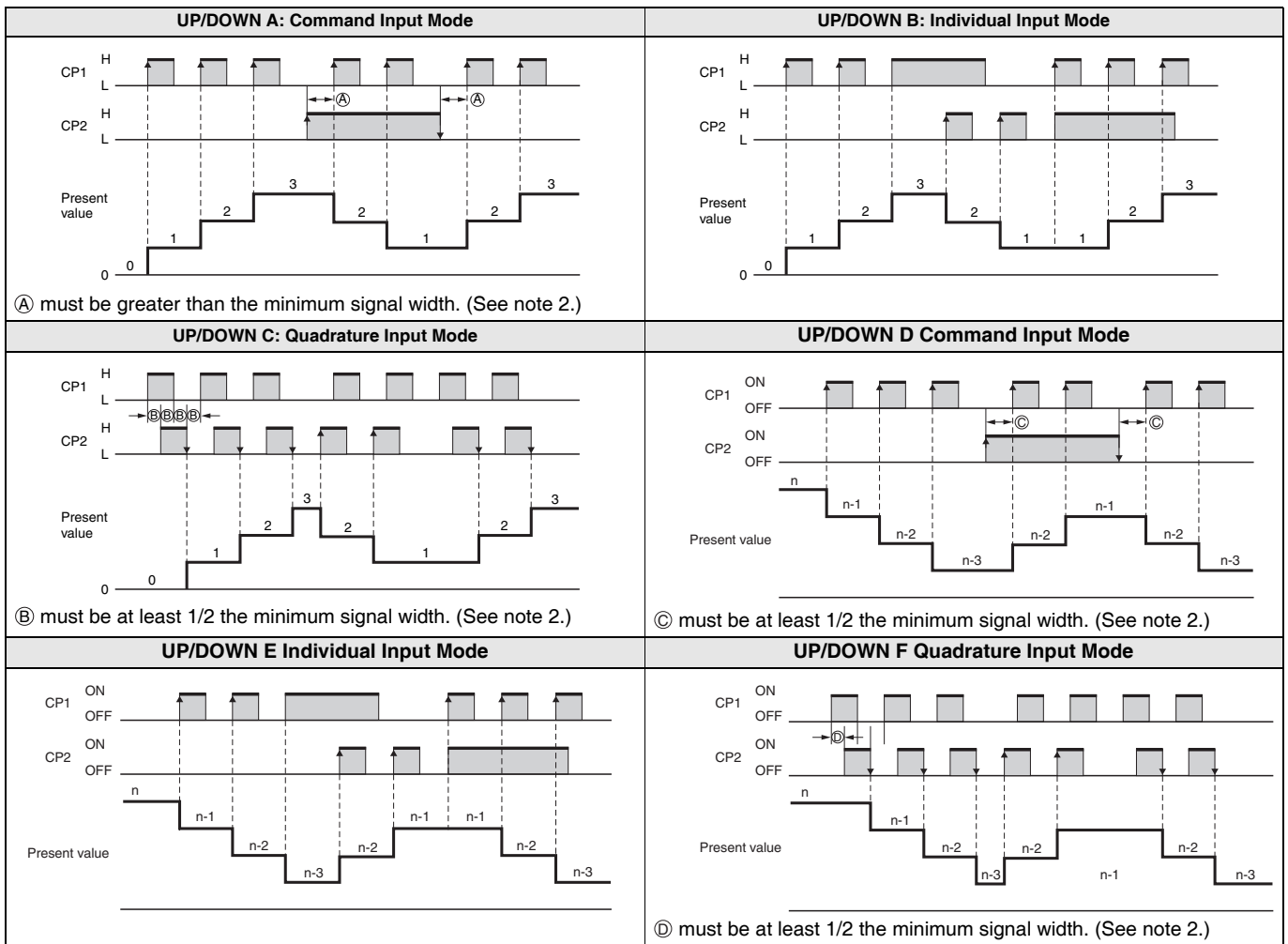

- Note:**
- If the configuration is set to dual counter, CP1 and CP2 inputs will operate in the same way as the count input (CP1) of UP (increment) mode.
  - Ⓐ must be greater than the minimum signal width and Ⓑ must be at least 1/2 the minimum signal width. If they are less, a count error of  $\pm 1$  may occur.  
Minimum signal width: 16.7 ms (when maximum counting speed = 30 Hz)  
100  $\mu$ s (when maximum counting speed = 5 kHz)
  - The meaning of the H and L symbols in the tables is explained below.

Input method Symbol	No-voltage input (NPN input)	Voltage input (PNP input)
H	Short-circuit	4.5 to 30 VDC
L	Open	0 to 2 VDC

# Input/Output Mode Settings

## I/O Functions for Counter Operation

If a 1-stage model or 2-stage model is used as twin counter, the operation for output 2 will be performed. When using a 2-stage model as a 1-stage preset counter, total and preset counter, or dual counter, OUT1 and OUT2 turn ON and OFF simultaneously.

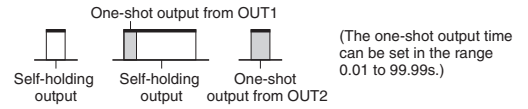

		Input mode		Operation after count completion			
		UP	DOWN				
Output mode setting	N			The outputs and present value display are held until reset/reset 1 is input.			
		UP/DOWN A, B, C			UP/DOWN D, E, F		
		UP			DOWN		
	F				The present value display continues to increase/decrease. The outputs are held until reset/reset 1 is input.		
		UP/DOWN A, B, C				UP/DOWN D, E, F	
		UP				DOWN	

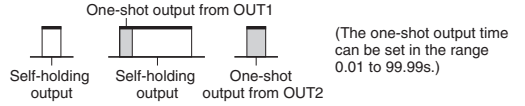

		Input mode		Operation after count completion	
Output mode setting	C	UP	DOWN	<p>As soon as the count reaches SV, the present value display returns to the reset start status. The present value display does not show the present value upon count-up. The outputs repeat one-shot operation. OUT1 self-holding output turns OFF after the OUT2 one-shot output time. The OUT1 one-shot output time is independent of OUT2.</p>	
		UP/DOWN A, B, C	UP/DOWN D, E, F		
		UP	DOWN		
		UP/DOWN A, B, C	UP/DOWN D, E, F		
	R	UP	DOWN		<p>The present value display returns to the reset start status after the one-shot output time. The outputs repeat one-shot operation. OUT1 self-holding output turns OFF after the OUT2 one-shot output time. The OUT1 one-shot output time is independent of OUT2.</p>
		UP/DOWN A, B, C	UP/DOWN D, E, F		
		UP	DOWN		
		UP/DOWN A, B, C	UP/DOWN D, E, F		

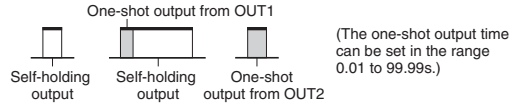

		Input mode		Operation after count completion
Output mode setting	K-1	UP	DOWN	The present value display continues to increase/decrease. OUT1 self-holding output turns OFF after the OUT2 one-shot output time. The OUT1 one-shot output time is independent of OUT2.
		UP/DOWN A, B, C	UP/DOWN D, E, F	
		UP	DOWN	
		UP/DOWN A, B, C	UP/DOWN D, E, F	
	P	UP	DOWN	The present value display does not change during the one-shot output time period, but the actual count returns to the reset start status. The output will return to one-shot mode. The outputs repeat one-shot operation. OUT1 self-holding output turns OFF after the OUT2 one-shot output time. The OUT1 one-shot output time is independent of OUT2.
		UP/DOWN A, B, C	UP/DOWN D, E, F	
		UP	DOWN	
		UP/DOWN A, B, C	UP/DOWN D, E, F	

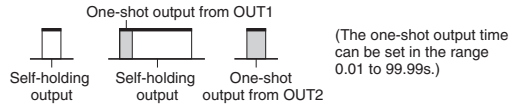

		Input mode		Operation after count completion
Output mode setting	Q	UP	DOWN	<p>The present value continues to increase/decrease for the one-shot output time, but returns to the reset start status after the one-shot output time has elapsed.</p> <p>The outputs repeat one-shot operation.</p> <p>OUT1 self-holding output turns OFF after the OUT2 one-shot output time. The OUT1 one-shot output time is independent of OUT2.</p>
		UP/DOWN A, B, C	UP/DOWN D, E, F	
		UP	DOWN	
		UP/DOWN A, B, C	UP/DOWN D, E, F	
	A	UP	DOWN	<p>The present value display and OUT1 self-holding output is held until reset/reset 1 is input.</p> <p>OUT1 and OUT2 are independent.</p>
		UP/DOWN A, B, C	UP/DOWN D, E, F	
		UP	DOWN	
		UP/DOWN A, B, C	UP/DOWN D, E, F	

- Note:**
- When the present value reaches 999999, it returns to 0.
  - Counting cannot be performed during reset/reset 1 input.
  - If reset/reset 1 is input while one-shot output is ON, one-shot output turns OFF.
  - If there is power interruption while output is ON, output will turn ON again when the power supply has recovered, if memory backup is enabled.  
For one-shot output, output will turn ON again for the duration of the output time setting once the power supply has recovered.
  - Do not use the counter function in applications where the count may be completed (again) while one-shot output is ON.
  - The setting range is 0 to 999999.

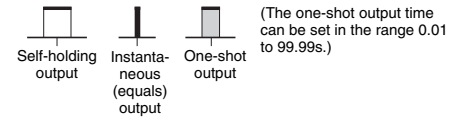

		Input mode	Operation after count completion
		UP/DOWN A, B, C	
Output mode setting	K-2		The display continues to increase/decrease until the overflow or underflow value is reached. Only a one-shot output is possible.
	D		The display continues to increase/decrease until the overflow or underflow value is reached. The outputs are ON while the count is equal.
	L		The display continues to increase/decrease until the overflow or underflow value is reached. OUT1 is held while the present value is less than or equal to set value 1. OUT2 is held while the present value is greater than or equal to set value 2.
	H		The display continues to increase/decrease until the overflow or underflow value is reached. OUT1 is held while the present value is greater than or equal to set value 1. OUT2 is held while the present value is greater than or equal to set value 2. <b>Note:</b> H mode is available only when using a 2-stage counter.

- Note:**
- Counting cannot be performed while the reset/reset 1 input is ON.
  - If reset/reset 1 input turns ON while the one-shot output is ON, the one-shot output turns OFF.
  - If there is power failure while the output is ON, the output will turn ON again when the power supply has recovered. For a one-shot output, the output will turn ON again for the duration of the output time setting once the power supply has recovered.
  - Do not use the counter function in applications where the count may be completed (again) while the one-shot output is ON.
  - The set values are between -99999 and 999999.

### Total and Preset Counter Operation

The H7BX has a total counter separate from the 1-stage preset counter for counting the total accumulated value.

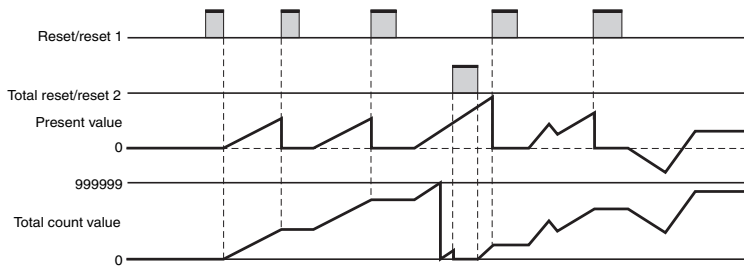

- The total counter continues to count the total accumulated value when the present value is reset using reset/reset 1 input (Reset Key).
- The total count value is reset when the total reset/reset 2 input is turned ON. If the Reset Key is pressed while the total count value is displayed, the total count value is reset. The present value is also reset at this time.
- The counting range of the total counter is -99,999 to 999,999. The total count value returns to 0 when it reaches the full scale limit.

### Batch Counter Operation

The H7BX has a batch counter separate from the 1-stage preset counter for counting the number of times the count has been completed.

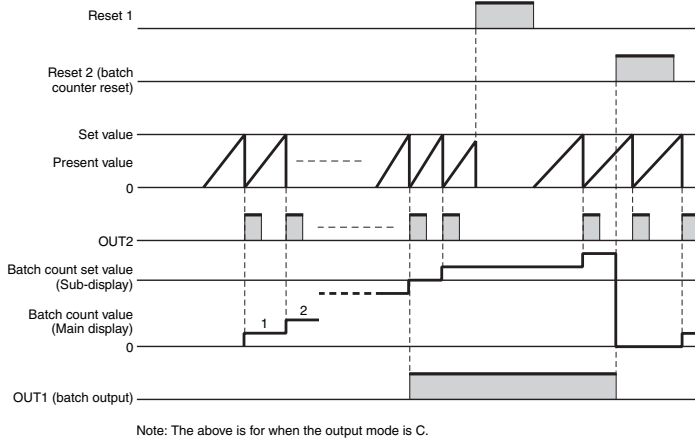

Note: The above is for when the output mode is C.

- The batch counter continues after count completion.
- Batch output is held until batch counter reset input turns ON.
- When the batch counter reset input is turned ON, the batch count value is reset, and batch output turns OFF.
- If the Reset Key is pressed while the batch count value is displayed, the batch count value is reset and batch output turns OFF. The present value is also reset at this time.
- The maximum counting speed for batch counter operation is 5 kHz.

- Note:**
1. The batch count value is held at 0 while the batch counter reset input is on.
  2. If the batch count set value is 0, batch count will be performed but there will be no batch output.
  3. The batch count value returns to 0 when it reaches 999,999.
  4. Once batch input has been turned ON, it will return to the ON state after power interruptions.
  5. If the batch count set value is changed from a value that is greater than the batch count value to one that is less, batch output will turn ON.
  6. After batch output turns ON, the ON state will be held even if the batch count set value is changed to a value greater than the batch count value.

### Dual Counter Operation

Using the dual counter allows the count from 2 inputs to be added or subtracted and the result displayed. It is possible to specify a set value for which output turns ON when the set value matches the added or subtracted result.

#### (1) Dual Count Calculating Mode = ADD

$$\text{Dual count value} = \text{CP1 PV} + \text{CP2 PV}$$

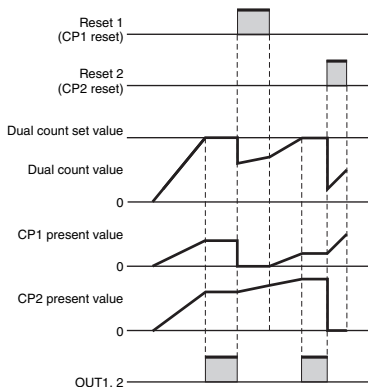

Note: The above is for when the output mode is N.

#### (2) Dual Count Calculating Mode = SUB

$$\text{Dual count value} = \text{CP1 PV} - \text{CP2 PV}$$

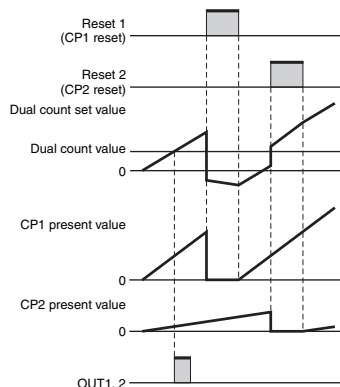

Note: The above is for when the output mode is K-2. SUB mode can be used only when K-2, D, L, or H is selected as the output mode with 6-digit models.

- The operation after count completion for the dual counter value is determined by the output mode.
- The CP1 present value is reset when reset 1 input is turned ON and the CP2 present value is reset when reset 2 input is turned ON.
- If the Reset Key is pressed while the dual count value, CP1 present value, or CP2 present value is displayed, all of the present values are reset and the outputs turn OFF. At this time, counting is not possible for CP1 or CP2 inputs.

- Note:**
1. Counting is not possible for CP1 while the reset 1 input is ON. CP2 is not affected. The dual count value will be calculated based on a CP1 present value of 0.
  2. Counting is not possible for CP2 while the reset 2 input is ON. CP1 is not affected. The dual count value will be calculated based on a CP2 present value of 0.
  3. The counting range for the dual count value is -99,999 to 999,999. The counting ranges for the CP1 present value and CP2 present value are 0 to 999,999. If a present value exceeds 999,999, FFFFFFFF will be displayed to indicate an overflow, and all counting will stop. If a present value goes below -999,999, "-----" will be displayed and all counting will stop.

## Twin Counter Operation

Two independent counters are built in.

	Counter 1	Counter 2
Counter input	CP1	CP2
Reset input	Reset 1	Reset 2
Present value display and setting	<p>Counter 1 display                      Counter 2 display</p> <p>Counter 1 present value                  Counter 2 present value</p> <p>Counter 1 set value                      Counter 2 set value</p>	
Reset operation	Only counters appearing on the display will be reset.	

- Note:**
1. Only 2-stage models
  2. Increment mode only for counters 1 and 2.
  3. The settings for prescaling and the decimal point are used by both counter 1 and 2.

## Reset Function List

Function	1-stage/2-stage counter	Total and preset counter		Batch counter		Dual counter		Twin counter	
		Present value/ set value	Total count value	Present value/ set value	Batch count value/ batch count set value	Dual count value/ dual count set value	CP1 present value/ CP2 present value	Present value 1/ Set value 1	Present value 2/ Set value 2
Display in run mode	Present value/ set value (1, 2)	Present value/ set value	Total count value	Present value/ set value	Batch count value/ batch count set value	Dual count value/ dual count set value	CP1 present value/ CP2 present value	Present value 1/ Set value 1	Present value 2/ Set value 2
Reset/ reset 1	Present value and output reset.	Present value and output reset.		Present value and output reset.		Only the CP1 present value is reset.		Only the CP1 present value is reset.	
Total reset/ reset 2	No effect.	Only the total count value is reset.		Batch count value and batch output reset.		Only the CP2 present value is reset.		Only the CP2 present value is reset.	
Reset Key	Present value and output reset.	Present value and output reset.	Present value, total count value, and output reset.	Present value and output reset.	Present value, batch count value, output and batch output reset.	CP1 present value, CP2 present value, dual count value, and output reset.		CP1 present value reset	CP2 present value reset



**Operating Procedures (Tachometer Function)** (H7BX-AW□ only)

**Switching from Counter to Tachometer**

The H7BX is factory-set to the 2-stage counter configuration. To switch to the tachometer configuration, use the procedure shown on the right. For details, refer to page 33.

\* Hold down the **MODE** Key and then press the **Up1** Key for at least 1 s.  
The mode will not change if the **Up1** Key is pressed first.

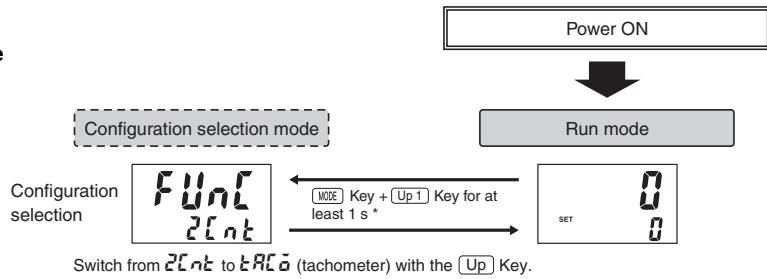

**Settings for Basic Operations**

Settings for basic functions can be performed with just the DIP switch.

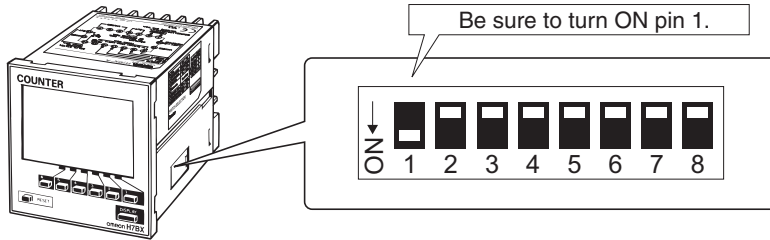

Item	OFF	ON
1 DIP switch settings enable/disable	Disabled	Enabled
2 Counting speed	30 Hz	10 kHz
3 Tachometer output mode	Refer to the table on the right.	
4		
5 Average processing	Refer to the table on the right.	
6		
7 ---	---	---
8 NPN/PNP input mode	NPN	PNP

Pin 3	Pin 4	Tachometer output mode
OFF	OFF	Upper and lower limit
ON	OFF	Area
OFF	ON	Upper limit
ON	ON	Lower limit

Pin 4	Pin 5	Average processing
OFF	OFF	OFF (no average processing)
ON	OFF	2 times
OFF	ON	4 times
ON	ON	8 times

**Note:** All pins are factory-set to OFF.

The ON/OFF status of the DIP switch pins can be confirmed using the front display. For details, refer to page 33.

**Convenient function**

**Caution**

- Always turn OFF the power supply before changing the DIP switch settings.
- Always turn ON pin 1 when performing settings with the DIP switch. Performing settings with the DIP switch is disabled when pin 1 is OFF.
- DIP switch setting changes will be updated when the power is turned ON. Perform the settings before performing installation and supplying power.
- Properly set the DIP switch to match the item being counted (or measured) and use the DIP switch monitor for confirmation.

After setting the DIP switch for basic operations, advanced functions can be added using the operation keys. For details, refer to page 26 to 28.

When the H7BX using as a tachometer, switch to the tachometer configuration using the procedure given on page 33.  
**Settings for Advanced Functions**

Settings that cannot be performed with the DIP switch are performed with the operation keys.

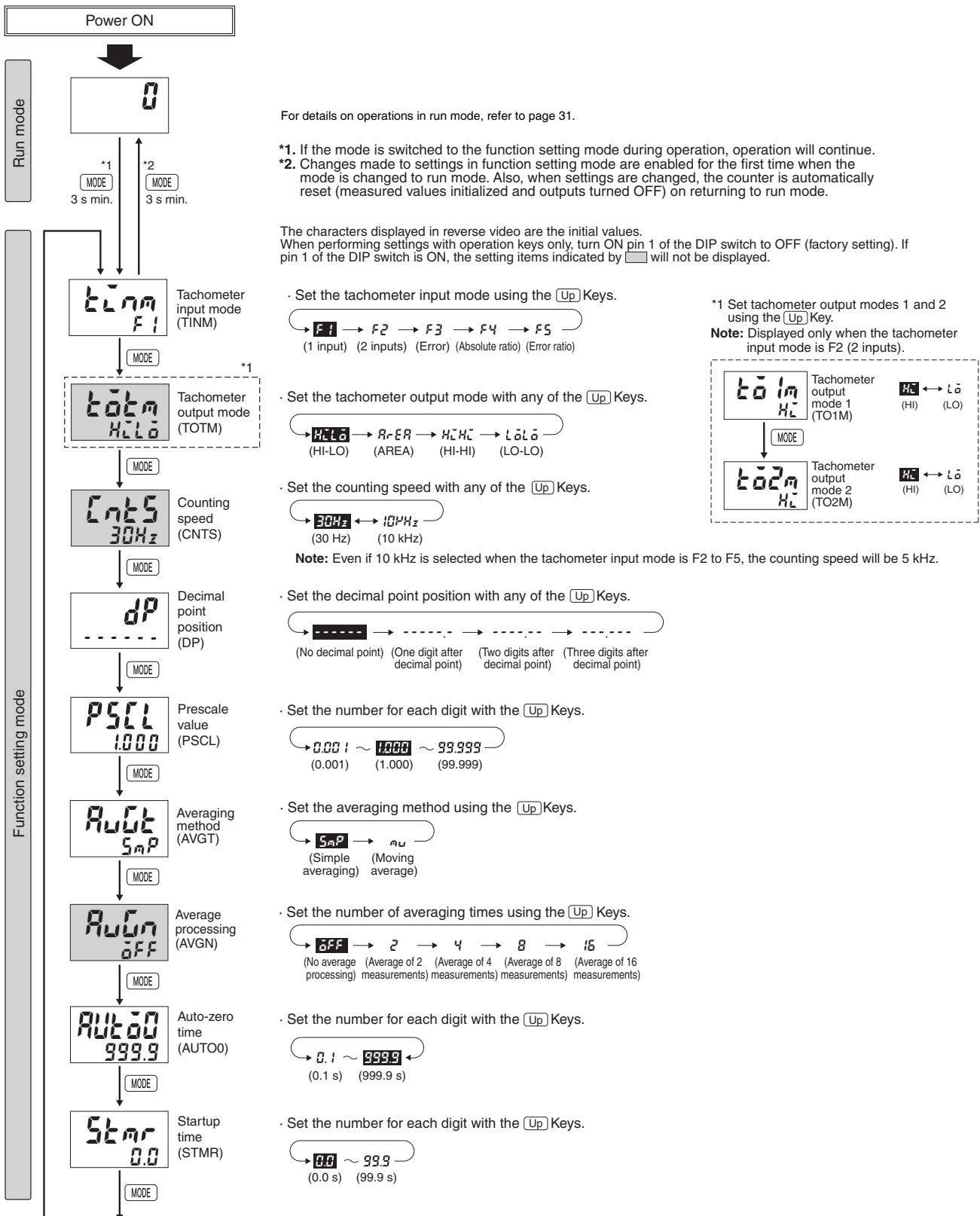

From next page To next page

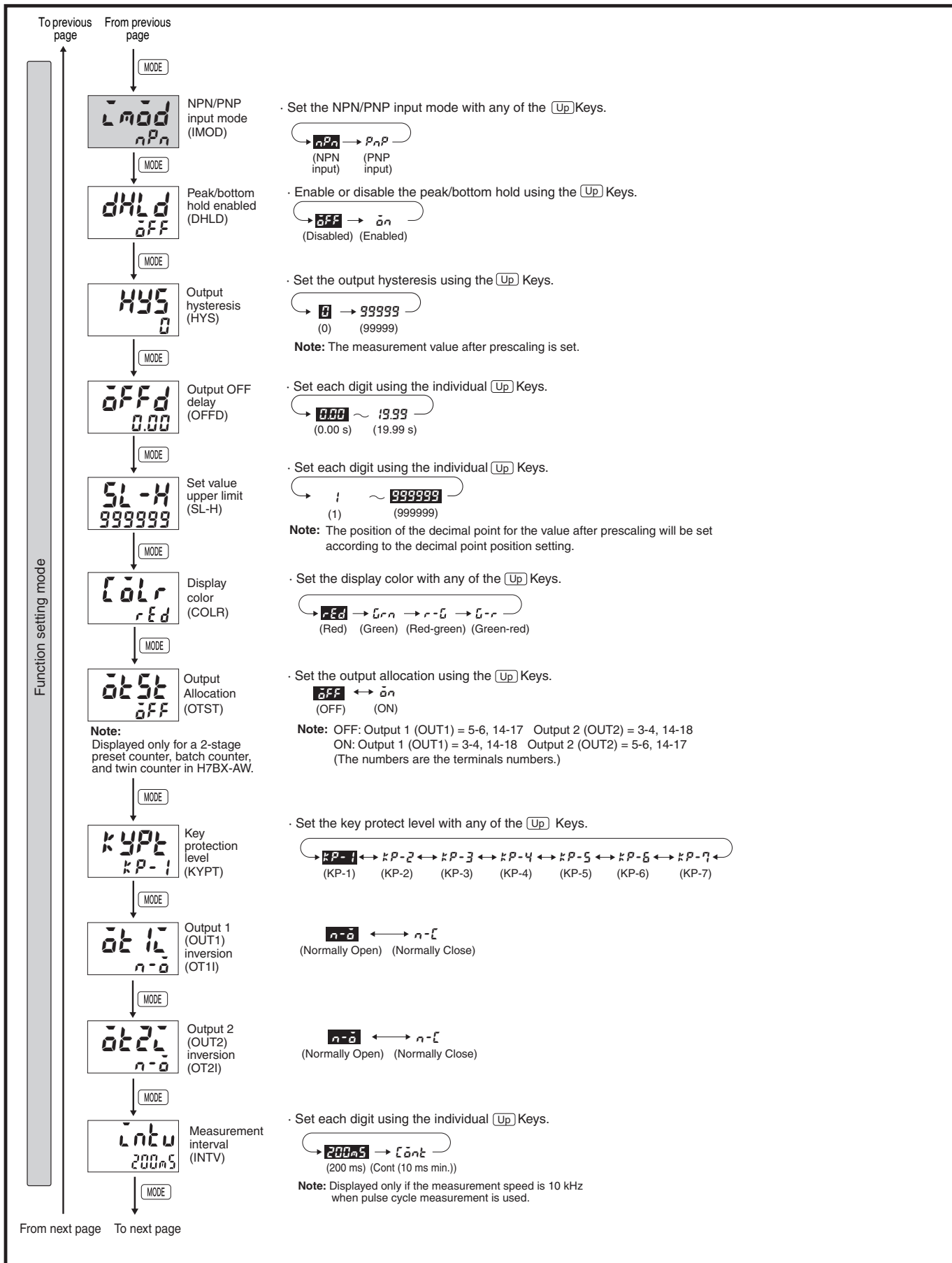

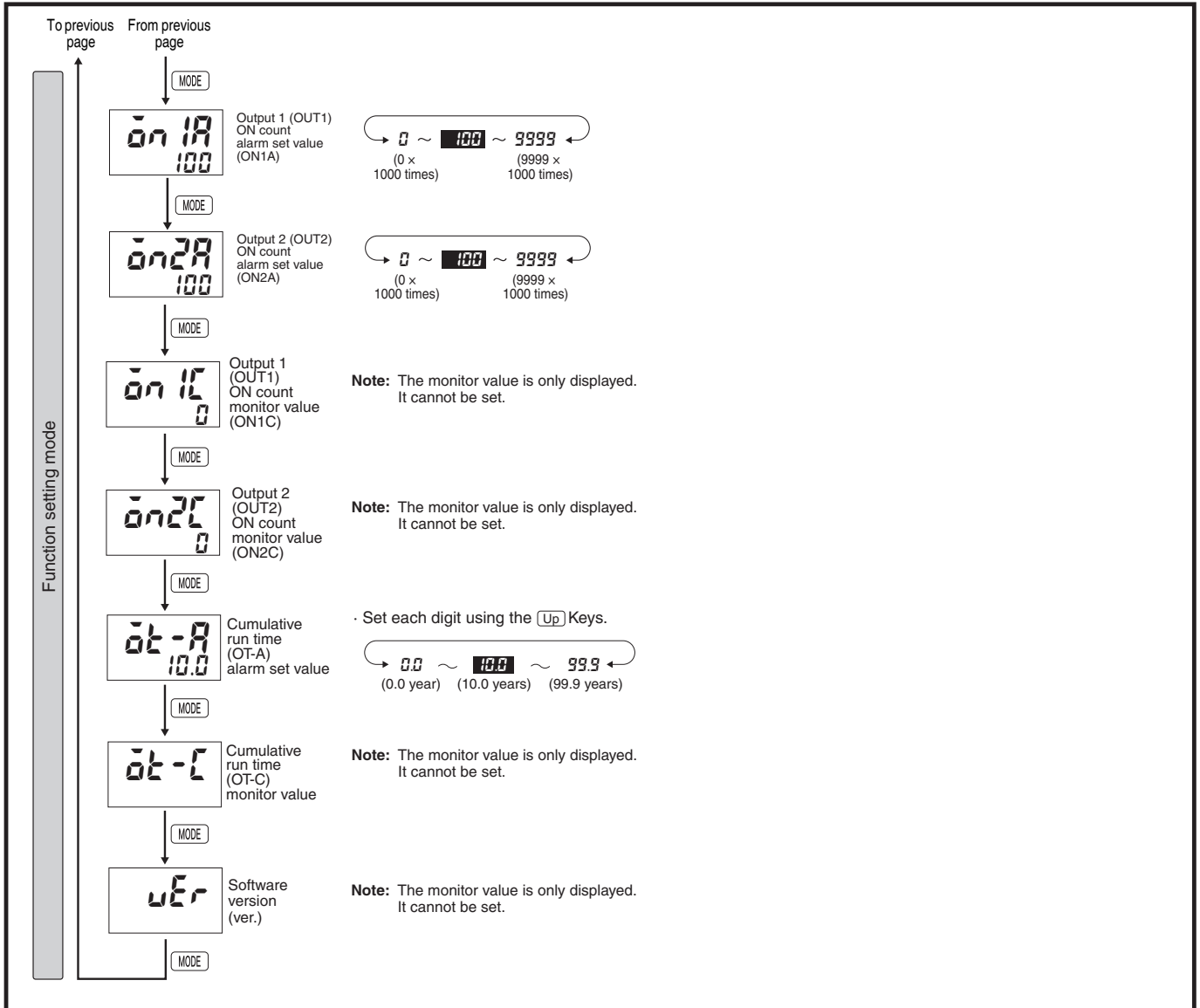

## Explanation of Functions

Settings marked with a star can be performed with the DIP switch.

### • Tachometer Input Mode (ㄟㄥㄇ)

Set the count input mode to one of the following: 1 input (ㄟㄈㄥ), 2 inputs (ㄟㄈㄥ), error (ㄟㄈㄥ), absolute ratio (ㄟㄈㄥ), or error ratio (ㄟㄈㄥ).

Input mode	Input	Internal processing	Application
1 input	Count 1	None	Operation with only one input.
2 inputs	Counts 1 and 2	None	Operation with two independent inputs.
Error	Counts 1 and 2	Count 1 input – Count 2 input	Measuring the difference between two inputs (error in number of revolutions).
Absolute ratio	Counts 1 and 2	Count 1 input ÷ Count 2 input	Measuring the ratio of two inputs (ratio of number of revolutions).
Error ratio	Counts 1 and 2	(Count 1 input – Count 2 input) ÷ Count 2 input	Measuring the ratio of error for two inputs (measuring the error ratio of number of revolutions).

### • Tachometer Output Mode (ㄟㄥㄥ) ★

Set the output method for control output based on the OUT1/OUT2 set value. Upper and lower limit (HI-LO), area (AREA), upper limit (HI-HI), and lower limit (LO-LO) can be set.

(For details on the operation of the output modes, refer to *Output Mode Settings* on page 32.)

### • Counting Speed (ㄟㄥㄥ) ★

Set the maximum counting speed (30 Hz/10 kHz) for CP1 input. If contacts are used for input signals, set the counting speed to 30 Hz. Processing to eliminate chattering is performed for this setting.

### • Decimal Point Position (ㄟㄥ) ★

Decide the decimal point position for the measurement value, OUT1 set value, and OUT2 set value.

### • Prescale Value (ㄟㄥㄥ) ★

It is possible to display the rate of rotation or the speed of a device or machine to which the H7BX is mounted by converting input pulses to a desired unit. If this prescaling function is not used, the input frequency (Hz) will be displayed.

The relationship between display and input is determined by the following equation. Set the prescale value according to the unit to be displayed.

$$\text{Displayed value} = f \times \alpha$$

f: Input pulse frequency (number of pulses in 1 second)

α: Prescale value

#### 1. Displaying the Rotation Rate

Display unit	Prescale value (α)
rpm	1/N × 60
rps	1/N

N: Number of pulses per revolution

Example: In order to display the rate of rotation for a machine that outputs 5 pulses per revolution in the form □□.□ rpm:

- Set the decimal point position to 1 decimal place.
- Using the formula, set the prescale value to  $1/N \times 60 = 60/5 = 12$ .

#### 2. Displaying the Speed

Display unit	Prescale value (α)
m/min	$\pi d \times 1/N \times 60$
m/s	$\pi d \times 1/N$

N: Number of pulses per revolution

d: Diameter of rotating body (m)

πd: Circumference (m)

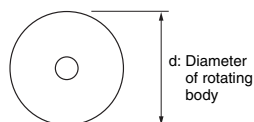

- Observe the following points when setting a prescale value. Set the set value to a value less than (Maximum countable value – Prescale value). Example: If the prescale value is 1.25 and the counting range is 0.000 to 999.999, set the set value to a value less than 998.749 (= 999.999 – 1.25). If the set value is set to a value greater than this, output will not turn ON.
- Output will turn ON, however, if a present value overflow occurs (FFFFFF).

Note: Incorrectly setting the prescale value will result in counting errors. Check that the setting has been performed correctly before using the H7BX.

### • Averaging Method (ㄟㄥㄥ) ★

A simple average or moving average can be selected for the averaging. With the moving average method, the average of the measurement values is displayed each sampling cycle, in contrast to a simple average, with which the average of the set number of samples is displayed.

### • Average Processing (ㄟㄥㄥ) ★

Flickering display and output chattering can be prevented by using average processing (simple averaging). Average processing can be set to one of five levels: no average processing, 2 times (i.e., the average of 2 measurement values), 4 times, 8 times or 16 times. The measurement cycle will be equal to the sampling cycle (200 ms) multiplied by the average processing setting (i.e., the number of times). Average processing enables fluctuating input signals to be displayed stably. Set the optimum number of times for the application.

### • Auto-zero Time (ㄟㄥㄥ) ★

It is possible to set the H7BX so that if there is no pulse for a certain time the display is force-set to 0. This time is called the auto-zero time. Set the auto-zero time to a time slightly longer than the estimated interval between input pulses. It will not be possible to make accurate measurements if the auto-zero time is set to a time shorter than the input pulse cycle. Setting a time that is too long may also result in problems, such as a time-lag between rotation stopping and the alarm turning ON.

### • Startup Time (ㄟㄥㄥ) ★

In order to prevent undesired output resulting from unstable input immediately after the power supply is turned ON, it is possible to prohibit measurement for a set time. This time is called the startup time.

It can also be used to stop measurement and disable output until the rotating body reaches the normal rate of rotation, after the power supply to the H7BX and rotating body are turned ON at the same time.

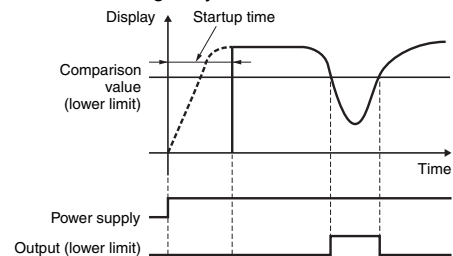

### • NPN/PNP Input Mode (ㄟㄥㄥ) ★

Select either NPN input (no-voltage input) or PNP input (voltage input) as the input format. Select an NPN input when using a 2-wire sensor. The same setting is used for all external inputs.

For details on input connections, refer to Input Connections on page 6.

• **Peak/bottom Hold Enabled (dHL d)**

This function records the peak and bottom (i.e., minimum) after counting starts (after turning ON the power supply or changing the configuration selection mode or function setting). The peak value is also held when the power supply is interrupted.

• **Output Hysteresis (HY5)**

This setting can be used to prevent output chattering if the measurement value fluctuates slightly near the set value. The measurement value after prescaling is set.

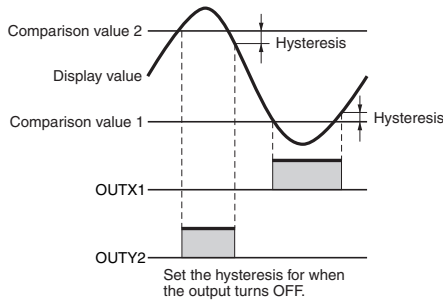

• **Output OFF Delay (dFFd)**

This function delays the timing for turning OFF comparative output by a certain time. The ON time can be held for the set time if the comparative result changes in a short time. Operation will continue and outputs will not change when holding the value.

• **Set Value Upper Limit (5L -H)**

Set the upper limit for the set value when it is set in run mode. The limit can be set to between 1 and 999999.

• **Display Color (LdLr)**

Set the color used for the measurement value.

	Control output OFF	Control output ON
rEd	Red (fixed)	
Grn	Green (fixed)	
r-G *1	Measured value displayed in red when both control outputs 1 and 2 are OFF.	Measured value displayed in green when either control output 1 or control output 2 is ON.
G-r *2	Measured value displayed in green when both control outputs 1 and 2 are OFF.	Measured value displayed in red when either control output 1 or control output 2 is ON.

\*1. If the tachometer output mode is set to AREA, however, the measured value is displayed in red when control output 1 is OFF and in green when control output 1 is ON.  
 \*2. If the tachometer output mode is set to AREA, however, the measured value is displayed in green when control output 1 is OFF and in red when control output 1 is ON.

• **Output Allocation (Settings applicable to only H7BX-AW) (dL5L)**

Set the allocation of outputs 1 and 2 (OUT1 and OUT2). If output allocation is OFF, output 1 (OUT1) is allocated to terminals (5)-(6), (14)-(17), and output 2 (OUT2) is allocated to terminals (3)-(4), (14)-(18). If output allocation is ON, output 1 (OUT1) is allocated to terminals (3)-(4), (14)-(18), and output 2 (OUT2) is allocated to terminals (5)-(6), (14)-(17).

• **Key Protect Level (KYPL)**

Set the key protect level. For details, refer to *Key Protect Level* on page 34.

• **Output inversion (dL iL, dLdL)**

Set logical inversion of output ON/OFF. In the case of two outputs, it is possible to individually set output inversion for each of output 1 and output 2 (OUT1 and OUT2). If output inversion is r-d (Normally Open), the output turns ON when the set value is reached. If output inversion is r-L (Normally close), the output turns OFF when the set value is reached.

• **Pulse Cycle Measurement/Pulse Width Measurement (LRLn)**

Set the measurement mode to pulse cycle measurement or pulse width measurement. With pulse cycle measurement, the number of pulse cycles that occur in 1 s is measured. With pulse width measurement, the ON time for one pulse is measured. An input OFF period of at least 20 ms is required for pulse width measurement. If there is no input pulse during pulse width measurement, the previously measured value will be held.

• **Display Unit (LRLk)**

When pulse cycle measurement is used, set the display unit to Hz (hertz) or s (seconds).

• **Counting Interval (LRLu)**

If the measurement speed is 10 kHz when pulse cycle measurement is used, set the measurement interval to 200 ms or Cont (10 ms min.).

• **ON Count Alarm Set Values for Outputs 1 and 2 (OUT1 and OUT2) (dL RL and dLdRL)**

The output ON count for notifying the replacement time can be set. For details, refer to page 35.

• **ON Count Monitor Values for Outputs 1 and 2 (OUT1 and OUT2) (dL RL and dLdRL)**

The monitor value for output 1 and 2 (OUT1 and OUT2) is only displayed. It cannot be set. The output ON count will be 1,000 times the displayed value.

• **Cumulative Run Time Alarm Set Value (dL -R)**

The cumulative run time for notifying the replacement time can be set. For details, refer to page 35.

• **Cumulative Run Time Monitor (dL -L)**

The cumulative run time is displayed. It is not a setting item. The numerical values are displayed in increments of 0.1 years.

## Operation in Run Mode

- Set the number for each digit with the **[Up]** Keys.

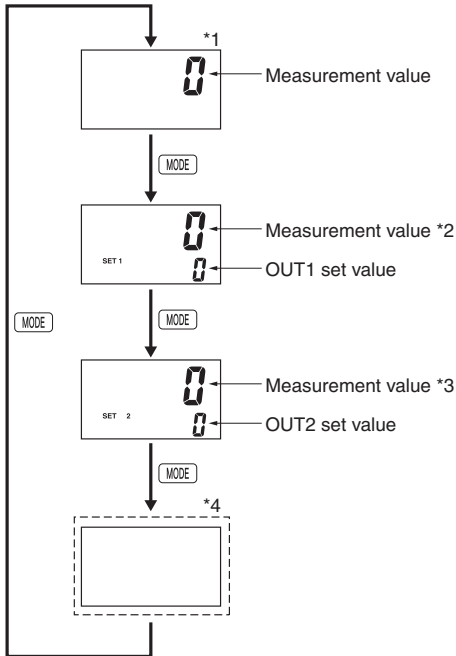
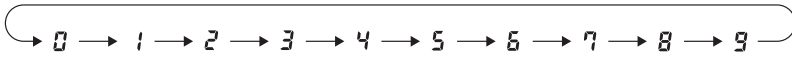

- Measurement Value**  
 Displays the currently measured value.
- OUT1/OUT2 Set Value**  
 Set OUT1 set value and OUT2 set value. The measurement value is compared to OUT1 set value and OUT2 set value and output is made according to the selected output mode.

- \*1. Not displayed for the 2-input mode.
- \*2. Measurement value 1 for the 2-input input mode.
- \*3. Measurement value 2 for the 2-input input mode.
- \*4. Peak/bottom hold enabled

Displayed when the input mode is not 2 inputs.

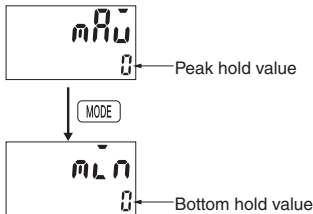

Displayed for the 2-input input mode.

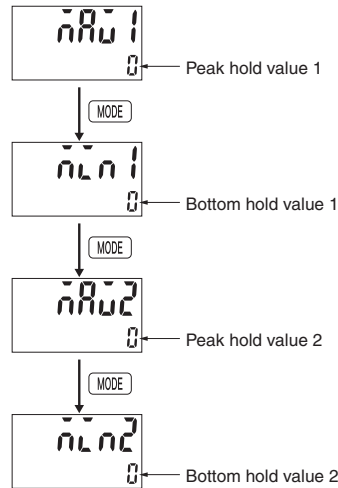

- Peak/bottom hold value**  
 The peak (maximum) and bottom (minimum) values are displayed after counting starts.
- Peak/bottom hold value 2**  
 Peaks (maximums) 1 and 2 and bottoms (minimums) 1 and 2 are displayed after counting starts.

**Note:** The held values will be initialized when the Reset Key (Hold Key) or reset 1 input is turned OFF while peak/bottom hold values 1 and 2 are being displayed. (The reset 2 input operates in the same way if the input mode is set to 2-input mode.)

## Output Mode Settings

<b>1 input</b> <b>Error</b> <b>Absolute ratio</b> <b>Error ratio</b>	<b>Upper and lower limit (HI-LO)</b>	<p>Measurement value</p> <p>(Upper-limit) OUT2 set value</p> <p>(Lower-limit) OUT1 set value</p> <p>OUT1</p> <p>OUT2</p>	<p>ON condition for OUT1: Measurement value <math>\leq</math> OUT1 set value</p> <p>ON condition for OUT2: Measurement value <math>\geq</math> OUT2 set value</p>									
	<b>Area (AREA)</b>	<p>Measurement value</p> <p>OUT2 set value</p> <p>OUT1 set value</p> <p>OUT1</p> <p>OUT2</p>	<table border="1"> <thead> <tr> <th>Condition</th> <th>OUT1 set value <math>\leq</math> OUT2 set value</th> <th>OUT1 set value <math>&gt;</math> OUT2 set value</th> </tr> </thead> <tbody> <tr> <td><b>ON condition for OUT1</b></td> <td>OUT1 set value <math>\leq</math> Measurement value <math>\leq</math> OUT2 set value</td> <td>OUT2 set value <math>\leq</math> Measurement value <math>\leq</math> OUT1 set value</td> </tr> <tr> <td><b>ON condition for OUT2</b></td> <td>Measurement value <math>&lt;</math> OUT1 set value or Measurement value <math>&gt;</math> OUT2 set value</td> <td>Measurement value <math>&lt;</math> OUT2 set value or Measurement value <math>&gt;</math> OUT1 set value</td> </tr> </tbody> </table>	Condition	OUT1 set value $\leq$ OUT2 set value	OUT1 set value $>$ OUT2 set value	<b>ON condition for OUT1</b>	OUT1 set value $\leq$ Measurement value $\leq$ OUT2 set value	OUT2 set value $\leq$ Measurement value $\leq$ OUT1 set value	<b>ON condition for OUT2</b>	Measurement value $<$ OUT1 set value or Measurement value $>$ OUT2 set value	Measurement value $<$ OUT2 set value or Measurement value $>$ OUT1 set value
	Condition	OUT1 set value $\leq$ OUT2 set value	OUT1 set value $>$ OUT2 set value									
	<b>ON condition for OUT1</b>	OUT1 set value $\leq$ Measurement value $\leq$ OUT2 set value	OUT2 set value $\leq$ Measurement value $\leq$ OUT1 set value									
	<b>ON condition for OUT2</b>	Measurement value $<$ OUT1 set value or Measurement value $>$ OUT2 set value	Measurement value $<$ OUT2 set value or Measurement value $>$ OUT1 set value									
<b>Upper limit (HI-HI)</b>	<p>Measurement value</p> <p>(Upper-limit) OUT2 set value</p> <p>(Upper-limit) OUT1 set value</p> <p>OUT1</p> <p>OUT2</p>	<p>ON condition for OUT1: Measurement value <math>\geq</math> OUT1 set value</p> <p>ON condition for OUT2: Measurement value <math>\geq</math> OUT2 set value</p>										
<b>Lower limit (LO-LO)</b>	<p>Measurement value</p> <p>(Lower-limit) OUT2 set value</p> <p>(Lower-limit) OUT1 set value</p> <p>OUT1</p> <p>OUT2</p>	<p>ON condition for OUT1: Measurement value <math>\leq</math> OUT1 set value</p> <p>ON condition for OUT2: Measurement value <math>\leq</math> OUT2 set value</p>										
<b>2 inputs</b>	<b>Upper limit (HI)</b>	<p><b>Output 1</b></p> <p>Comparison value 1</p> <p>CP1 display value</p> <p>OUT1</p>	<p><b>Output 2</b></p> <p>Comparison value 2</p> <p>CP2 display value</p> <p>OUT2</p>									
	<b>Lower limit (LO)</b>	<p><b>Output 1</b></p> <p>CP1 display value</p> <p>Comparison value 1</p> <p>OUT1</p>	<p><b>Output 2</b></p> <p>CP2 display value</p> <p>Comparison value 2</p> <p>OUT2</p>									



## Switching between Using a Preset Counter, Total and Preset Counter, Batch Counter, Dual Counter, Twin Counter, and Tachometer

Select which H7BX configuration to use (i.e., preset counter, total and preset counter, batch counter, dual counter, twin Counter, or tachometer) in the configuration selection mode. The H7BX is also equipped with a DIP switch monitor function, a convenient function that enables the settings of the DIP switch pins to be confirmed using the front display.

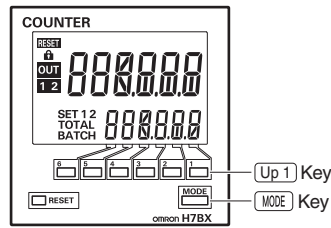
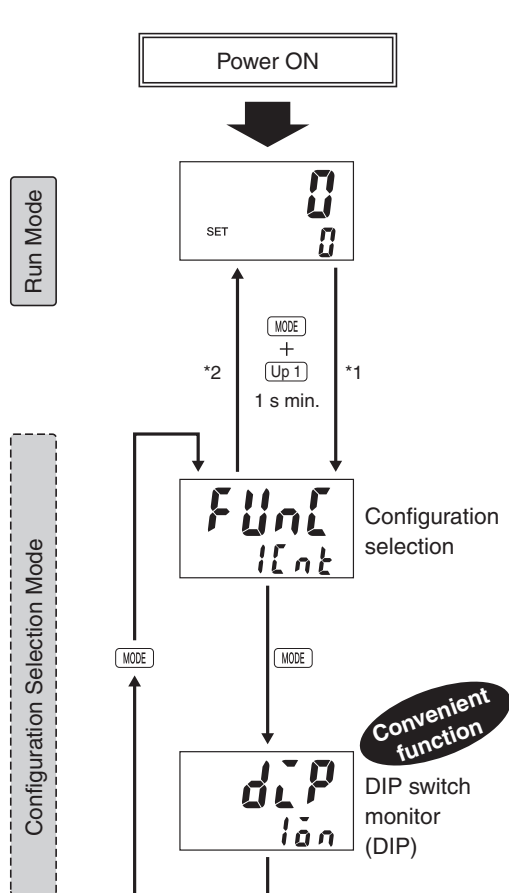

### Caution

To change the mode to configuration selection mode, press the **Up 1** Key for 1 s min. with the key held down. The mode will not change if the **Up 1** Key is pressed first.

Select the configuration with any of the **Up** Keys.

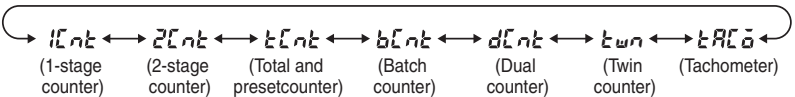

- Note:**
- The configuration that can be selected depend on the model.
  - The default setting is for a 1-stage preset counter. (For models with a 2-stage setting, the default is for a 2-stage preset counter.)

The status of the DIP switch pins (1 to 8) can be confirmed using the **Up** Keys.

**Note:** This display is possible only if DIP switch pin 1 (DIP switch settings) is set to ON (i.e., enabled).

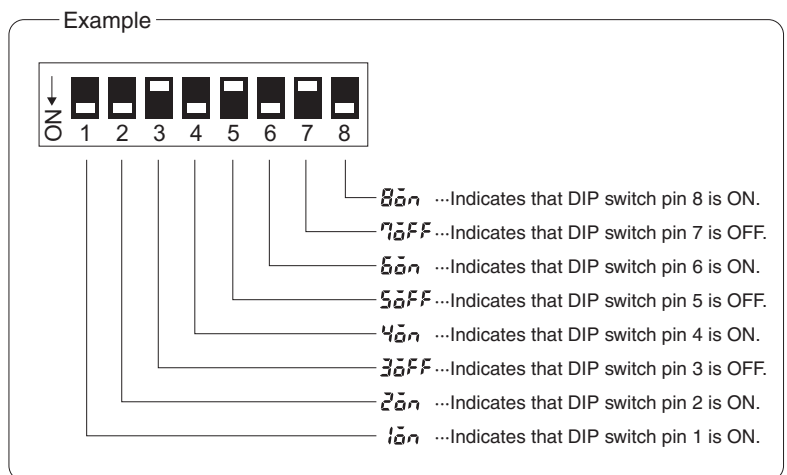

\*1. When the mode is changed to configuration selection mode, the present value is reset, outputs turns OFF, and counting (measuring) stops.

\*2. Setting changes made in configuration selection mode are enabled when the mode is changed to run mode.

If the configuration is changed, the set value (or set value 1 and set value 2), OUT1 set value or OUT2 set value are initialized.

## Key Protect Level

When the key-protect switch is set to ON, it is possible to prevent setting errors by prohibiting the use of certain operation keys by specifying the key protect level (KP-1 to KP-5). The key protect indicator is lit while the key-protect switch is set to ON. Confirm the ON/OFF status of the key protect switch after the H7BX is mounted to the panel.

Key protection is enable by short-circuited key protection terminals.

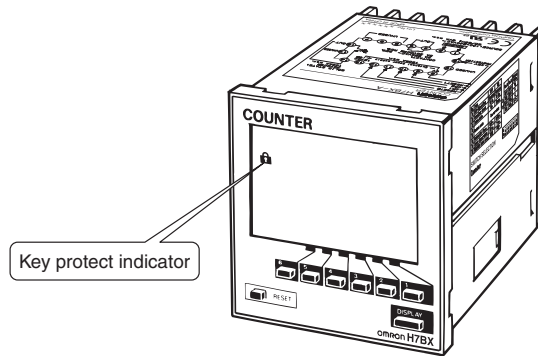

Level	Meaning	Details			
		Changing mode (See note.)	Switching display in run mode	Reset Key	Up/Down Keys (Up Keys for 6-digit models)
KP-1 (default setting)		No	Yes	Yes	Yes
KP-2		No	Yes	No	Yes
KP-3		No	Yes	Yes	No
KP-4		No	Yes	No	No
KP-5		No	No	No	No
KP-6		No	No	Yes	Yes
KP-7		No	No	No	Yes

**Note:** Changing to configuration selection mode and function selection mode.

## Replacement Time Notification Function

The counter includes parts such as electrolytic capacitors and relays that deteriorate with time or with repeated operations.

The H7BX is equipped with a function for notifying the replacement time by the cumulative run time and ON count of the relay contact.

When either the cumulative run time or ON count of the relay contact reaches the replacement time, **RPLC** (REPLACE) can be displayed on the Timer. For details on RPLC display, refer to *Self-diagnostic Function* on this page.

### Cumulative Run Time Alarm Set Value ( $\bar{\alpha}t - R$ )

The cumulative run time can be set in a range from 0.0 to 99.9 years.

The replacement time notification function is disabled if 0 is set.

10 years is set in the default settings.

If the cumulative run time reaches the alarm set value or above, an RPLC (replacement time) error can be displayed on the Timer.

### Output ON Count Alarm Set Value ( $\bar{\alpha}n - R, \bar{\alpha}n iR, \bar{\alpha}n zR$ )

Set the alarm value for the output ON count.

The limit can be set between 0×1000 (0 times) and 9999×1000 (9,999,000 times). Only the underlined values are set. The alarm will be disabled if 0 is set.

100,000 times is set in the default settings.

If the total output ON count reaches the alarm set value or above, an RPLC (replacement time) error can be displayed on the Timer.

## Self-diagnostic Function

The following displays will appear if an error occurs.

Main display	Sub-display	Description	Output status	Correction method	Set value after reset
----- *4	No change	Present value underflow *2	No change	Either perform reset key or turn ON reset input. *5	No change
FFFFFF *4	No change	Present value overflow *3	No change	Either perform reset key or turn ON reset input. *5	No change
E1	Not lit	CPU error	OFF	Either perform reset key or reset the power supply.	No change
E2	Not lit	Memory error (RAM)	OFF	Turn ON the power again.	No change
E2	Sum	Memory error (non-volatile memory) *1	OFF	Reset key	Factory setting
RPLC *7	No change	The cumulative run time or output ON count reaches the replacement time	No change	Reset key *6	No change

\*1. This includes times when the life of the non-volatile memory has expired.

\*2. This occurs if the present value or total count value falls below -99999.

\*3. This occurs in the following conditions if the present value (i.e., measurement value) exceeds 999999.

- For Output Modes K-2, D, L, or H
- Dual counter or tachometer operation is used.

\*4. Display flashes.(1-second cycles)

\*5. This does not apply when tachometer operation is used.

\*6. This is displayed if the alarm value setting for either of the two outputs is exceeded if a model with two outputs is used. The total ON count will not be cleared by reset operation.

\*7. The normal display and **RPLC** will appear alternately.

When reset operation is performed, **RPLC** will not be displayed even if the alarm set value is exceeded.

(Monitoring is possible, however, because the counter will continue without the cumulative run time and output ON count being cleared.)

**RPLC** is displayed again if the power is turned OFF/ON after the **RPLC** display is cleared during recovery by the reset operation. If you do not want to display **RPLC** when the power is turned OFF/ON, either change the alarm set value to the present value or above, or change the alarm set value to 0 to disable it.

## Safety Precautions

Refer to *Safety Precautions for All Counters*.

### Caution

Minor injury due to electric shock may occasionally occur. Do not touch any of the terminals while power is being supplied.



Fire may occasionally occur. Tighten the terminal screws to a torque of 0.5 to 0.6 N·m (4.4 to 5.3 in·lb).



Minor injury due to explosion may occasionally occur. Do not use the H7BX where subject to flammable or explosive gas.



If the output relay is used beyond its life expectancy, its contacts may become fused or there may be a risk of fire.



Use the output relay within its rated load and electrical life expectancy. The life expectancy of the output relay varies considerably according to its usage.

Minor electric shock, fire, or malfunction may occasionally occur. Never attempt to disassemble, modify, or repair the H7BX or touch any of the internal parts.



### Precautions for Safe Use

#### Operating Environment

- The H7BX is intended for indoor use only. Do not use the H7BX outdoors or in any of the following locations.
  - Locations subject to sudden or extreme changes in temperature.
  - Locations where high humidity may result in condensation.
  - Locations subject to direct sunlight.
  - Locations subject to corrosive gas.
  - Locations subject to excessive dust or dirt.
- This is a class A product (for industrial environments). In residential areas, it may cause radio interference, in which case the user may be required to take adequate measures to reduce interference.
- Use the H7BX within the specified ratings for operating temperature and humidity. Temperature rise may shorten the service life of H7BX if it is used near a power supply or other heat-generating objects.
- Use the H7BX within the specified ratings for vibration, shock, and splashing water.
- The H7BX is not oil resistant. Do not use it in locations subject to oil.
- Install the H7BX well away from any sources of excessive static electricity, such as pipes transporting molding materials, power, or liquids.
- Store the H7BX within the specified ratings. If the H7BX has been stored at temperatures of  $-10^{\circ}\text{C}$  or lower, let it stand for 3 hours or longer at room temperature before turning ON the power supply.

#### Power Supply

- Maintain voltage fluctuations in the power supply within the specified range.
- Internal elements may be destroyed if a voltage beyond the rated voltage is applied.
- When the power is turned ON, an inrush current will flow for a short time (approx. 10 A for 2 ms). Depending on the power supply capacity, operation may not start. Be sure to use a power supply with a sufficient capacity.

- Use a commercial power supply as the AC power supply for the H7BX. Using an inverter output with an output frequency of 50/60 Hz as the power supply may cause the H7BX to produce smoke or become damaged by burning.
- Use a switch, relay, or other device with contacts so that the rated power supply voltage will be reached within 2 s. If the power supply voltage is not reached quickly enough, the outputs may malfunction.
- Use a switch, relay, or other device with contacts so that the rated power supply voltage will be reached within 2 s. If the power supply voltage is not reached quickly enough, the outputs may malfunction.

#### Installation and Wiring

- To mount the H7BX to a panel, attach the two supplied adapters to the left and right sides of the H7BX, and securely tighten the knurled screws on the adapters by hand, maintaining a balance between them. Damage may result if the knurled screws are excessively tightened with pliers or other tools.
- Be sure to wire the terminals correctly.
- Up to two wires of the same size and type can be inserted into a single terminal.
- Do not connect more than two crimp terminals to each H7BX terminal.
- Use the specified wires for wiring.
  - Applicable wire: AWG 24 to AWG 18 (equal to a cross-sectional area of 0.20 to 0.82 mm<sup>2</sup>)
  - Solid wire or twisted wire (copper), operating temperature over 70°C.
- Separate the H7BX, the devices that generate input signals, and input signal wires from any potential sources of noise, such as high-voltage lines.

#### Handling

- Do not use organic solvents (such as paint thinner or benzene), strong alkaline, or strong acids because they will damage the external finish.
- Approximately 14 V will be output to the input terminals when the H7BX is used with the key protection input terminals and no-voltage input (NPN input) is used. To prevent charging accidents, connect a diode to the power supply circuit of input devices if input devices are used with a power supply of less than 14 V.
- Do not connect loads that exceed the rated output current. The output elements may be destroyed, possibly resulting in short-circuit or open-circuit faults.
- When using heaters, be sure to use a thermal switch for the load circuit.
- Always connect a diode to protect against counter electromotive force when using an inductive load. H7BX electromotive force may destroy output elements, possibly resulting in short-circuit or open-circuit faults.
- Install a switch or circuit breaker that allows the operator to immediately turn OFF the power, and label it to clearly indicate its function.
- Check that the display (backlight and LCD) is operating normally. Some operating environments may accelerate deterioration of the indicators, LCD, and resin components and cause display malfunctions. Periodically inspect and replace parts.

### Precautions for Correct Use

- Inrush current generated by turning ON or OFF the power supply may deteriorate contacts in the power supply circuit. Turn ON or OFF using a device with a rated current of 10 A or higher.
- Input signals may be accepted, not accepted, or unstable for the following time when the power supply is turned ON or OFF. Set the system to allow leeway in the timing of input signals.

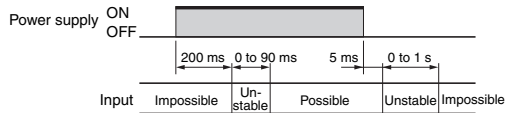

- This H7BX always compares the count value with the set value. Thus, if you change the set value during operation, please remember that the output will turn ON when the set value becomes equal to the count value.
- With the factory setting, the output will turn ON when power is supplied to the H7BX because the set value and count value are both zero. While resetting, however, the output stays OFF.
- Non-volatile memory is used as memory when the power is interrupted. The write life of the Non-volatile memory is 100,000 writes. The Non-volatile memory is written when settings are changed, or the power is turned OFF.
- Water resistance will be lost if the front sheet is peeled off or torn. Do not use the H7BX if the front sheet is missing or torn.
- Abide by all local ordinances and regulations when disposing of the H7BX.
- External Power Supply  
Reduce the load current as shown in the diagram on the right according to the power supply voltage if a DC power supply is used for models specified for 24 VAC/12 to 24 VDC.

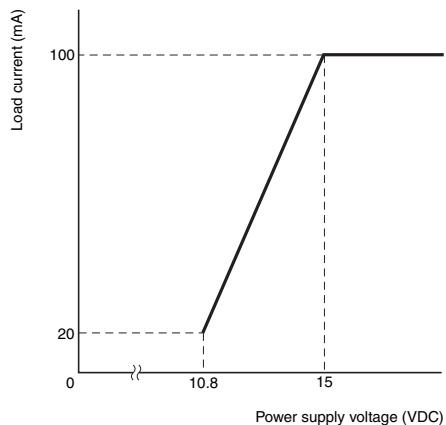

## Terms and Conditions Agreement

### Read and understand this catalog.

Please read and understand this catalog before purchasing the products. Please consult your OMRON representative if you have any questions or comments.

### Warranties.

(a) Exclusive Warranty. Omron's exclusive warranty is that the Products will be free from defects in materials and workmanship for a period of twelve months from the date of sale by Omron (or such other period expressed in writing by Omron). Omron disclaims all other warranties, express or implied.

(b) Limitations. OMRON MAKES NO WARRANTY OR REPRESENTATION, EXPRESS OR IMPLIED, ABOUT NON-INFRINGEMENT, MERCHANTABILITY OR FITNESS FOR A PARTICULAR PURPOSE OF THE PRODUCTS. BUYER ACKNOWLEDGES THAT IT ALONE HAS DETERMINED THAT THE PRODUCTS WILL SUITABLY MEET THE REQUIREMENTS OF THEIR INTENDED USE.

Omron further disclaims all warranties and responsibility of any type for claims or expenses based on infringement by the Products or otherwise of any intellectual property right. (c) Buyer Remedy. Omron's sole obligation hereunder shall be, at Omron's election, to (i) replace (in the form originally shipped with Buyer responsible for labor charges for removal or replacement thereof) the non-complying Product, (ii) repair the non-complying Product, or (iii) repay or credit Buyer an amount equal to the purchase price of the non-complying Product; provided that in no event shall Omron be responsible for warranty, repair, indemnity or any other claims or expenses regarding the Products unless Omron's analysis confirms that the Products were properly handled, stored, installed and maintained and not subject to contamination, abuse, misuse or inappropriate modification. Return of any Products by Buyer must be approved in writing by Omron before shipment. Omron Companies shall not be liable for the suitability or unsuitability or the results from the use of Products in combination with any electrical or electronic components, circuits, system assemblies or any other materials or substances or environments. Any advice, recommendations or information given orally or in writing, are not to be construed as an amendment or addition to the above warranty.

See <http://www.omron.com/global/> or contact your Omron representative for published information.

### Limitation on Liability: Etc.

OMRON COMPANIES SHALL NOT BE LIABLE FOR SPECIAL, INDIRECT, INCIDENTAL, OR CONSEQUENTIAL DAMAGES, LOSS OF PROFITS OR PRODUCTION OR COMMERCIAL LOSS IN ANY WAY CONNECTED WITH THE PRODUCTS, WHETHER SUCH CLAIM IS BASED IN CONTRACT, WARRANTY, NEGLIGENCE OR STRICT LIABILITY.

Further, in no event shall liability of Omron Companies exceed the individual price of the Product on which liability is asserted.

### Suitability of Use.

Omron Companies shall not be responsible for conformity with any standards, codes or regulations which apply to the combination of the Product in the Buyer's application or use of the Product. At Buyer's request, Omron will provide applicable third party certification documents identifying ratings and limitations of use which apply to the Product. This information by itself is not sufficient for a complete determination of the suitability of the Product in combination with the end product, machine, system, or other application or use. Buyer shall be solely responsible for determining appropriateness of the particular Product with respect to Buyer's application, product or system. Buyer shall take application responsibility in all cases.

NEVER USE THE PRODUCT FOR AN APPLICATION INVOLVING SERIOUS RISK TO LIFE OR PROPERTY OR IN LARGE QUANTITIES WITHOUT ENSURING THAT THE SYSTEM AS A WHOLE HAS BEEN DESIGNED TO ADDRESS THE RISKS, AND THAT THE OMRON PRODUCT(S) IS PROPERLY RATED AND INSTALLED FOR THE INTENDED USE WITHIN THE OVERALL EQUIPMENT OR SYSTEM.

### Programmable Products.

Omron Companies shall not be responsible for the user's programming of a programmable Product, or any consequence thereof.

### Performance Data.

Data presented in Omron Company websites, catalogs and other materials is provided as a guide for the user in determining suitability and does not constitute a warranty. It may represent the result of Omron's test conditions, and the user must correlate it to actual application requirements. Actual performance is subject to the Omron's Warranty and Limitations of Liability.

### Change in Specifications.

Product specifications and accessories may be changed at any time based on improvements and other reasons. It is our practice to change part numbers when published ratings or features are changed, or when significant construction changes are made. However, some specifications of the Product may be changed without any notice. When in doubt, special part numbers may be assigned to fix or establish key specifications for your application. Please consult with your Omron's representative at any time to confirm actual specifications of purchased Product.

### Errors and Omissions.

Information presented by Omron Companies has been checked and is believed to be accurate; however, no responsibility is assumed for clerical, typographical or proofreading errors or omissions.