

# Programmable Controller

# CP2E

## Micro PLC designed to support data collection and Machine to Machine communication

- Network Model features Ethernet connectivity  
+ 4-axis positioning: CP2E-N type
- Standard Model features axis control: CP2E-S type
- Essential Model features basic control: CP2E-E type



CP2E-E20DR-A

CP2E-N30D□□

## Features

- Two built-in Ethernet ports with Ethernet switching function:  
Ready for Machine to Machine communication (CP2E-N type)
- Up to three serial ports: Open connectivity to serial devices (CP2E-N type)
- Four-axis positioning function with linear interpolation (CP2E-N type)
- Battery-free operation and backup reduce maintenance
- Function blocks and structured text improve programming efficiency
- Operating temperature range from -20 to 60 °C for reliable use in special applications
- Input/output terminal LED indicators for quick troubleshooting

# CP2E

## System Configuration

### N□□-type CPU Unit

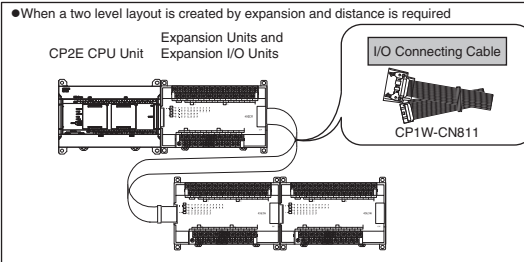
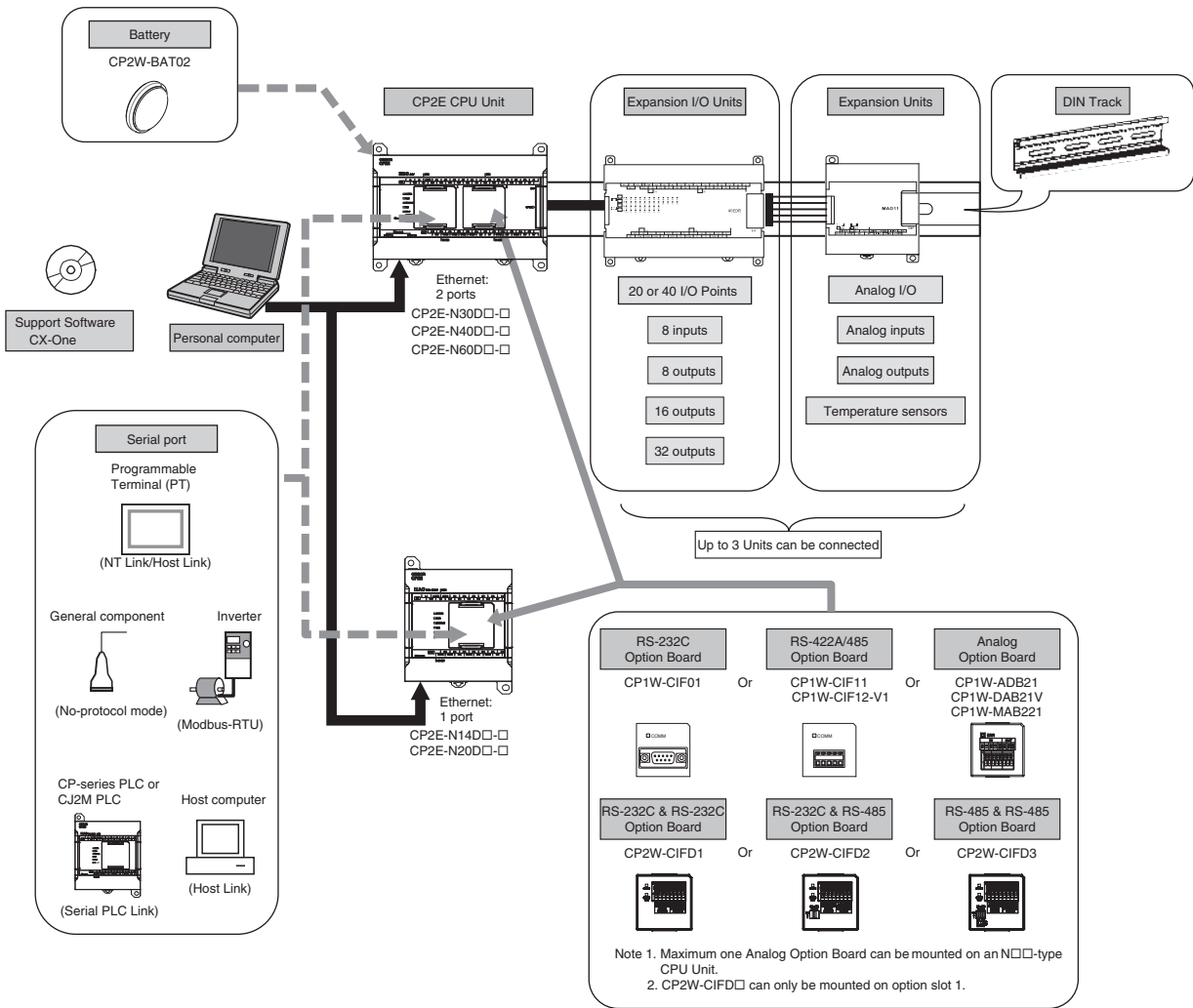

### S□□-type CPU Unit

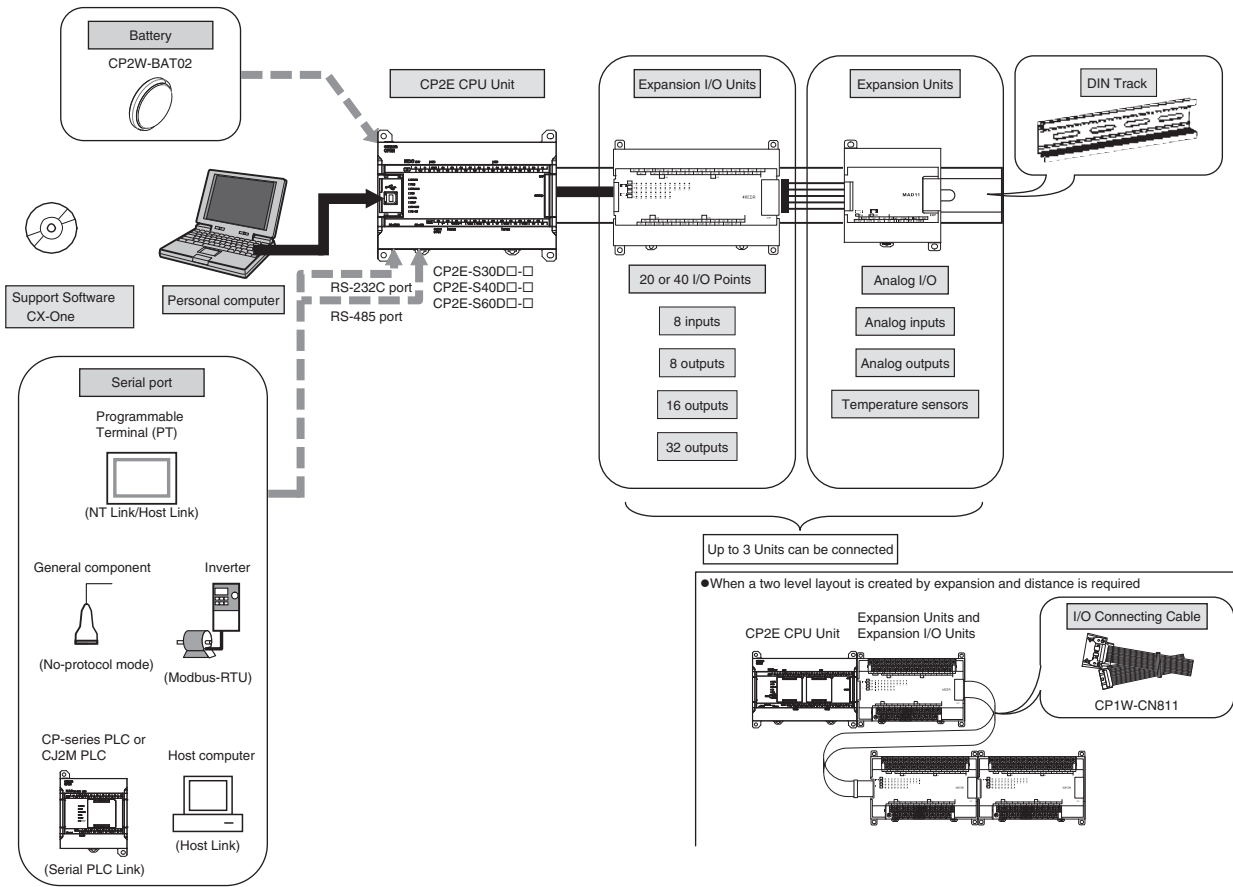

### E□□-type CPU Unit

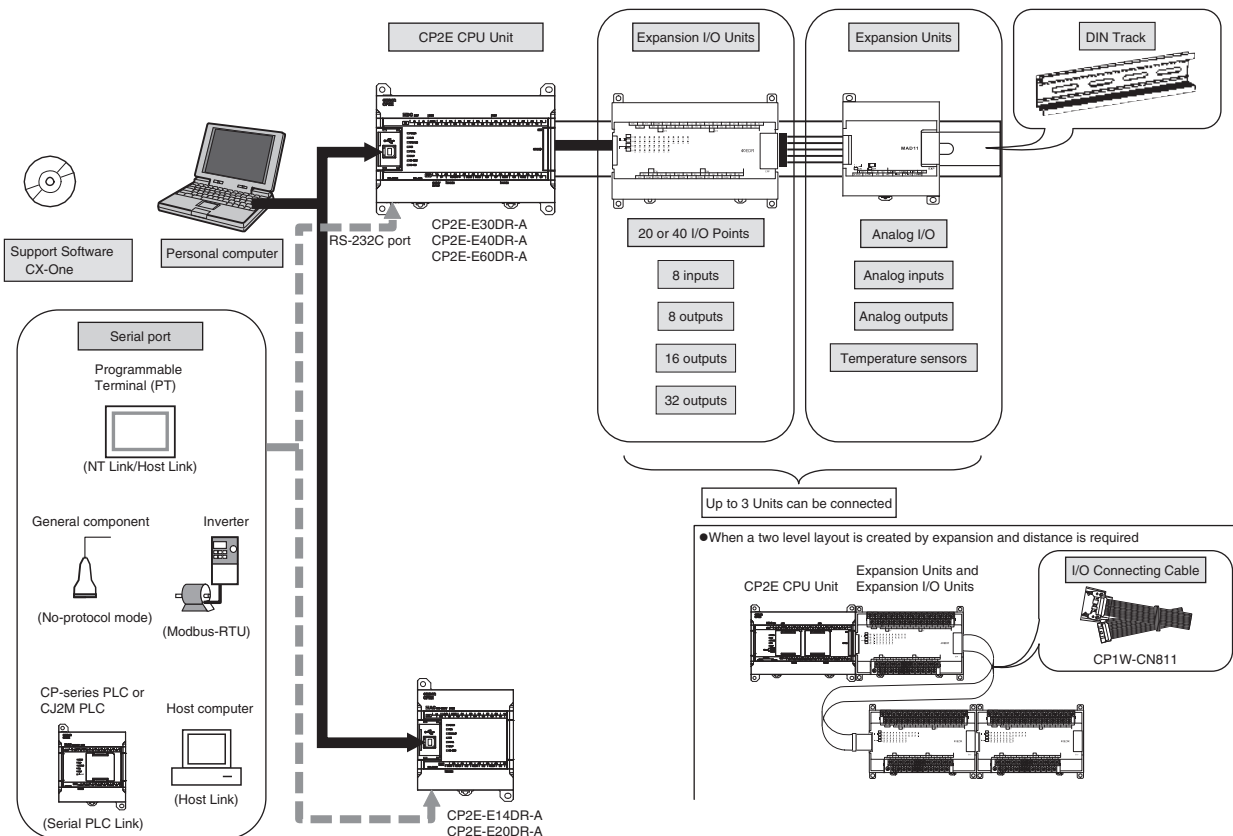

# CP2E

## Model Number Structure

---

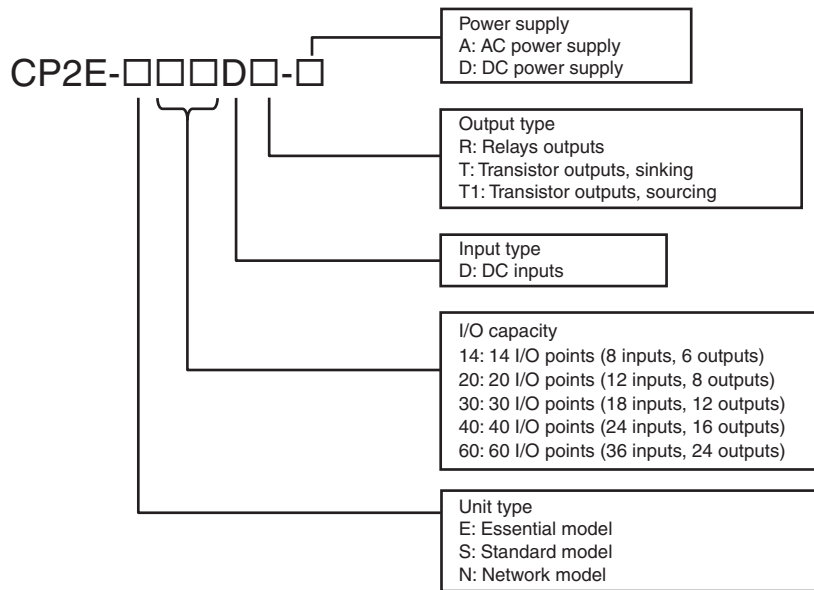





# Ordering Information

## Applicable standards

Refer to the OMRON website ([www.ia.omron.com](http://www.ia.omron.com)) or ask your OMRON representative for the most recent applicable standards for each model.



## CPU Unit

### CP2E-N-type/Network model





| Number of points   | Specifications |           |           |                       |                                    |                      |                                    |           | Model                |        |                      |
|--|----------------|-----------|-----------|-----------------------|------------------------------------|----------------------|------------------------------------|-----------|----------------------|--------|----------------------|
|  | Power Supply   | Inputs    | Outputs   | Output type           | Program capacity                   | Data memory capacity | Current consumption                |           |                      |        |                      |
|  |                |           |           |                       |                                    |                      | 5 VDC                              | 24 VDC    |                      |        |                      |
| <b>CPU Units with 14 points</b><br>   | 100 to 240 VAC | 8 points  | 6 points  | Relay                 | 10K steps (FB capacity: 10K steps) | 16K words            | 0.15 A                             | 0.05 A    | <b>CP2E-N14DR-A</b>  |        |                      |
|  | 24 VDC         |           |           | Transistor (sinking)  |                                    |                      | 0.21 A                             | 0.02 A    | <b>CP2E-N14DT-A</b>  |        |                      |
|  |                |           |           | Relay                 |                                    |                      | 0.15 A                             | 0.05 A    | <b>CP2E-N14DR-D</b>  |        |                      |
|  |                |           |           | Transistor (sinking)  |                                    |                      | 0.21 A                             | 0.02 A    | <b>CP2E-N14DT-D</b>  |        |                      |
|  |                |           |           | Transistor (sourcing) |                                    |                      | 0.22 A                             | 0.02 A    | <b>CP2E-N14DT1-D</b> |        |                      |
| <b>CPU Units with 20 points</b><br>   | 100 to 240 VAC | 12 points | 8 points  | Relay                 |                                    |                      | 10K steps (FB capacity: 10K steps) | 16K words | 0.17 A               | 0.06 A | <b>CP2E-N20DR-A</b>  |
|  | 24 VDC         |           |           | Transistor (sinking)  |                                    |                      |                                    |           | 0.27 A               | 0.02 A | <b>CP2E-N20DT-A</b>  |
|  |                |           |           | Relay                 |                                    |                      |                                    |           | 0.17 A               | 0.06 A | <b>CP2E-N20DR-D</b>  |
|  |                |           |           | Transistor (sinking)  |                                    |                      |                                    |           | 0.27 A               | 0.02 A | <b>CP2E-N20DT-D</b>  |
|  |                |           |           | Transistor (sourcing) |                                    |                      |                                    |           | 0.26 A               | 0.02 A | <b>CP2E-N20DT1-D</b> |
| <b>CPU Units with 30 points</b><br>  | 100 to 240 VAC | 18 points | 12 points | Relay                 | 10K steps (FB capacity: 10K steps) | 16K words            |                                    |           | 0.41 A               | 0.07 A | <b>CP2E-N30DR-A</b>  |
|  | 24 VDC         |           |           | Transistor (sinking)  |                                    |                      |                                    |           | 0.52 A               | 0.03 A | <b>CP2E-N30DT-A</b>  |
|  |                |           |           | Relay                 |                                    |                      |                                    |           | 0.37 A               | 0.07 A | <b>CP2E-N30DR-D</b>  |
|  |                |           |           | Transistor (sinking)  |                                    |                      |                                    |           | 0.51 A               | 0.03 A | <b>CP2E-N30DT-D</b>  |
|  |                |           |           | Transistor (sourcing) |                                    |                      |                                    |           | 0.51 A               | 0.03 A | <b>CP2E-N30DT1-D</b> |
| <b>CPU Units with 40 points</b><br> | 100 to 240 VAC | 24 points | 16 points | Relay                 |                                    |                      | 10K steps (FB capacity: 10K steps) | 16K words | 0.39 A               | 0.09 A | <b>CP2E-N40DR-A</b>  |
|  | 24 VDC         |           |           | Transistor (sinking)  |                                    |                      |                                    |           | 0.59 A               | 0.03 A | <b>CP2E-N40DT-A</b>  |
|  |                |           |           | Relay                 |                                    |                      |                                    |           | 0.39 A               | 0.09 A | <b>CP2E-N40DR-D</b>  |
|  |                |           |           | Transistor (sinking)  |                                    |                      |                                    |           | 0.59 A               | 0.03 A | <b>CP2E-N40DT-D</b>  |
|  |                |           |           | Transistor (sourcing) |                                    |                      |                                    |           | 0.59 A               | 0.03 A | <b>CP2E-N40DT1-D</b> |
| <b>CPU Units with 60 points</b><br> | 100 to 240 VAC | 36 points | 24 points | Relay                 | 10K steps (FB capacity: 10K steps) | 16K words            |                                    |           | 0.44 A               | 0.13 A | <b>CP2E-N60DR-A</b>  |
|  | 24 VDC         |           |           | Transistor (sinking)  |                                    |                      |                                    |           | 0.71 A               | 0.03 A | <b>CP2E-N60DT-A</b>  |
|  |                |           |           | Relay                 |                                    |                      |                                    |           | 0.41 A               | 0.13 A | <b>CP2E-N60DR-D</b>  |
|  |                |           |           | Transistor (sinking)  |                                    |                      |                                    |           | 0.71 A               | 0.03 A | <b>CP2E-N60DT-D</b>  |
|  |                |           |           | Transistor (sourcing) |                                    |                      |                                    |           | 0.71 A               | 0.03 A | <b>CP2E-N60DT1-D</b> |

# CP2E

## CP2E-S-type/Standard model

| Number of points   | Specifications |           |           |                       |                                  |                      |                     |        | Model                |
|--|----------------|-----------|-----------|-----------------------|----------------------------------|----------------------|---------------------|--------|----------------------|
|  | Power Supply   | Inputs    | Outputs   | Output type           | Program capacity                 | Data memory capacity | Current consumption |        |                      |
|  |                |           |           |                       |                                  |                      | 5 VDC               | 24 VDC |                      |
| <b>CPU Units with 30 points</b><br> | 100 to 240 VAC | 18 points | 12 points | Relay                 | 8K steps (FB capacity: 8K steps) | 8K words             | 0.12 A              | 0.07 A | <b>CP2E-S30DR-A</b>  |
|  | 24 VDC         |           |           | Transistor (sinking)  |                                  |                      | 0.28 A              | 0.02 A | <b>CP2E-S30DT-D</b>  |
|  |                |           |           | Transistor (sourcing) |                                  |                      |                     |        | <b>CP2E-S30DT1-D</b> |
| <b>CPU Units with 40 points</b><br> | 100 to 240 VAC | 24 points | 16 points | Relay                 | 8K steps (FB capacity: 8K steps) | 8K words             | 0.13 A              | 0.09 A | <b>CP2E-S40DR-A</b>  |
|  | 24 VDC         |           |           | Transistor (sinking)  |                                  |                      | 0.34 A              | 0.02 A | <b>CP2E-S40DT-D</b>  |
|  |                |           |           | Transistor (sourcing) |                                  |                      |                     |        | <b>CP2E-S40DT1-D</b> |
| <b>CPU Units with 60 points</b><br> | 100 to 240 VAC | 36 points | 24 points | Relay                 | 8K steps (FB capacity: 8K steps) | 8K words             | 0.16 A              | 0.13 A | <b>CP2E-S60DR-A</b>  |
|  | 24 VDC         |           |           | Transistor (sinking)  |                                  |                      | 0.48 A              | 0.02 A | <b>CP2E-S60DT-D</b>  |
|  |                |           |           | Transistor (sourcing) |                                  |                      |                     |        | <b>CP2E-S60DT1-D</b> |

## CP2E-E-type/Essential model









| Number of points   | Specifications |           |           |             |                                  |                      |                     |        | Model               |
|--|----------------|-----------|-----------|-------------|----------------------------------|----------------------|---------------------|--------|---------------------|
|  | Power Supply   | Inputs    | Outputs   | Output type | Program capacity                 | Data memory capacity | Current consumption |        |                     |
|  |                |           |           |             |                                  |                      | 5 VDC               | 24 VDC |                     |
| <b>CPU Units with 14 points</b><br> | 100 to 240 VAC | 8 points  | 6 points  | Relay       | 4K steps (FB capacity: 4K steps) | 4K words             | 0.06 A              | 0.04 A | <b>CP2E-E14DR-A</b> |
| <b>CPU Units with 20 points</b><br> |                | 12 points | 8 points  | Relay       |                                  |                      | 0.08 A              | 0.06 A | <b>CP2E-E20DR-A</b> |
| <b>CPU Units with 30 points</b><br> |                | 18 points | 12 points | Relay       |                                  |                      | 0.12 A              | 0.07 A | <b>CP2E-E30DR-A</b> |
| <b>CPU Units with 40 points</b><br> |                | 24 points | 16 points | Relay       |                                  |                      | 0.13 A              | 0.09 A | <b>CP2E-E40DR-A</b> |
| <b>CPU Units with 60 points</b><br> |                | 36 points | 24 points | Relay       |                                  |                      | 0.16 A              | 0.13 A | <b>CP2E-E60DR-A</b> |

## Optional Products

### Battery

| Product name   | Specifications   | Model      |
|--|--|------------|
| Battery<br> | Mounted in an N/S□□-type CPU Unit.<br>Mount the Battery when using the clock function.<br>A Battery cannot be mounted to an E□□-type CPU Unit. | CP2W-BAT02 |









### Option Board

| Product name   | Specifications  | Current consumption |        | Model         |
|--|---|---------------------|--------|---------------|
|  |   | 5 VDC               | 24 VDC |               |
| RS-232C Option Board<br>                  | Mounted in the option slot of an N□□-type CPU Unit and can be used as an RS-232C port.<br>Maximum transmission distance: 15 m   | 0.04 A              | ---    | CP1W-CIF01    |
| Non-isolated RS-422A/485 Option Board<br> | Mounted in the option slot of an N□□-type CPU Unit and can be used as an RS-422A/485 port.<br>Maximum transmission distance: 50 m   | 0.04 A              | ---    | CP1W-CIF11    |
| Isolated RS-422A/485 Option Board<br>     | Mounted in the option slot of an N□□-type CPU Unit and can be used as an RS-422A/485 port.<br>Maximum transmission distance: 500 m  | 0.04 A              | ---    | CP1W-CIF12-V1 |
| RS-232C&RS-232C Option Board<br>        | Mounted in the option slot of an N□□-type CPU Unit and can be used as two RS-232C ports.<br>Maximum transmission distance: 15 m   | 0.04 A              | ---    | CP2W-CIFD1    |
| RS-232C&RS-485 Option Board<br>         | Mounted in the option slot of an N□□-type CPU Unit and can be used as one RS-232C port and one isolated RS-485 port.<br>Maximum transmission distance:<br>15 m (RS-232C)<br>500 m (RS-485)  | 0.06 A              | ---    | CP2W-CIFD2    |
| RS-485&RS-485 Option Board<br>          | Mounted in the option slot of an N□□-type CPU Unit and can be used as two isolated RS-485 ports.<br>Maximum transmission distance: 500 m  | 0.08 A              | ---    | CP2W-CIFD3    |
| Analog Input Option Board<br>           | Mounted in the option slot of an N□□-type CPU Unit and can be used as an analog input module. <ul style="list-style-type: none"> <li>2 analog inputs               <ul style="list-style-type: none"> <li>0 to 10 V (Resolution: 1/4000)</li> <li>0 to 20 mA (Resolution: 1/2000)</li> </ul> </li> </ul>  | 0.02 A              | ---    | CP1W-ADB21    |
| Analog Output Option Board<br>          | Mounted in the option slot of an N□□-type CPU Unit and can be used as an analog output module. <ul style="list-style-type: none"> <li>2 analog outputs               <ul style="list-style-type: none"> <li>0 to 10 V (Resolution: 1/4000)</li> </ul> </li> </ul>   | 0.06 A              | ---    | CP1W-DAB21V   |
| Analog Input/Output Option Board<br>    | Mounted in the option slot of an N□□-type CPU Unit and can be used as an analog input/output module. <ul style="list-style-type: none"> <li>2 analog inputs               <ul style="list-style-type: none"> <li>0 to 10 V (Resolution: 1/4000)</li> <li>0 to 20 mA (Resolution: 1/2000)</li> </ul> </li> <li>2 analog outputs               <ul style="list-style-type: none"> <li>0 to 10 V (Resolution: 1/4000)</li> </ul> </li> </ul> | 0.08 A              | ---    | CP1W-MAB221   |

- Note:**
- Maximum one Analog Option Board can be mounted on an N□□-type CPU Unit.
  - The CP1W-ME05M Memory Cassette, CP1W-DAM01 LCD Option Board, and CP1W-CIF41 Ethernet Option Board cannot be used with the CP2E CPU Unit.
  - Option Boards cannot be used with the E/S□□-type CPU Unit.

**Expansion I/O Units and Expansion Units (for E30/40/60, S30/40/60, or N30/40/60 CPU Units)**

E14/20 or N14/20 CPU Units do not support Expansion I/O Units and Expansion Units.

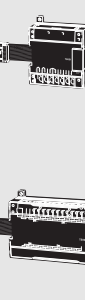
| Unit type                | Product name   | Specifications |         |   | Current consumption (A)  |   | Model               |            |            |
|--------------------------|--|----------------|---------|---|--|---|---------------------|------------|------------|
|                          |  | Inputs         | Outputs | Output type   | 5 V  | 24 V  |                     |            |            |
| CP1W Expansion I/O Units | <br>Input Unit                | 8              | ---     | 24 VDC Input  | 0.018  | ---   | CP1W-8ED            |            |            |
|                          | <br>Output Units              | ---            | 8       | Relay   | 0.026  | 0.044   | CP1W-8ER            |            |            |
|                          |  |                |         | Transistor (sinking)  | 0.075  | ---   | CP1W-8ET            |            |            |
|                          |  |                |         | Transistor (sourcing)   | 0.075  | ---   | CP1W-8ET1           |            |            |
|                          | <br>Output Units              | ---            | 16      | Relay   | 0.042  | 0.090   | CP1W-16ER           |            |            |
|                          |  |                |         | Transistor (sinking)  | 0.076  | ---   | CP1W-16ET           |            |            |
|                          |  |                |         | Transistor (sourcing)   | 0.076  | ---   | CP1W-16ET1          |            |            |
|                          | <br>Output Units              | ---            | 32      | Relay   | 0.049  | 0.131   | CP1W-32ER           |            |            |
|                          |  |                |         | Transistor (sinking)  | 0.113  | ---   | CP1W-32ET           |            |            |
|                          |  |                |         | Transistor (sourcing)   | 0.113  | ---   | CP1W-32ET1          |            |            |
|                          | <br>I/O Units                 | 12             | 8       | Relay   | 0.103  | 0.044   | CP1W-20EDR1         |            |            |
|                          |  |                |         | Transistor (sinking)  | 0.130  | ---   | CP1W-20EDT          |            |            |
|                          |  |                |         | Transistor (sourcing)   | 0.130  | ---   | CP1W-20EDT1         |            |            |
|                          |  | 24             | 16      | Relay   | 0.080  | 0.090   | CP1W-40EDR          |            |            |
| Transistor (sinking)     |  |                |         | 0.160   | ---  | CP1W-40EDT  |                     |            |            |
| Transistor (sourcing)    |  |                |         | 0.160   | ---  | CP1W-40EDT1   |                     |            |            |
| CP1W Expansion Units     | <br>Analog Input Unit       | 4CH            | ---     | Input range: 0 to 5 V, 1 to 5 V, 0 to 10 V, ±10 V, 0 to 20 mA, or 4 to 20 mA. | Resolution: 1/6000   | 0.100   | 0.090               | CP1W-AD041 |            |
|                          |  |                |         |   | Resolution: 1/12000  | 0.100   | 0.050               | CP1W-AD042 |            |
|                          | <br>Analog Output Unit      | ---            | 2CH     | 4CH   | Output range: 1 to 5 V, 0 to 10 V, ±10 V, 0 to 20 mA, or 4 to 20 mA.   | Resolution: 1/6000  | 0.040               | 0.095      | CP1W-DA021 |
|                          |  |                |         |   |  | Resolution: 1/6000  | 0.080               | 0.124      | CP1W-DA041 |
|                          |  |                |         |   |  | Resolution: 1/12000   | 0.070               | 0.160      | CP1W-DA042 |
|                          | <br>Analog I/O Unit         | 4CH            | 4CH     | 4CH   | Input range: 0 to 5 V, 1 to 5 V, 0 to 10 V, ±10 V, 0 to 20 mA, or 4 to 20 mA. Output range: 1 to 5 V, 0 to 10 V, ±10 V, 0 to 20 mA, or 4 to 20 mA. | Resolution: 1/12000   | 0.120               | 0.170      | CP1W-MAD44 |
|                          |  |                |         |   |  | Resolution: 1/12000   | 0.120               | 0.120      | CP1W-MAD42 |
|                          |  |                |         |   |  | Resolution: 1/6000  | 0.083               | 0.110      | CP1W-MAD11 |
|                          | <br>Temperature Sensor Unit | 2CH            | ---     | ---   | Sensor type: Thermocouple (J or K)   | 0.040   | 0.059               | CP1W-TS001 |            |
|                          |  |                |         |   |  | 0.040   | 0.059               | CP1W-TS002 |            |
|                          |  | 2CH            | ---     | ---   | ---  | Sensor type: Platinum resistance thermometer (Pt100 or JPt100)  | 0.054               | 0.073      | CP1W-TS101 |
|                          |  |                |         |   |  |   | 0.054               | 0.073      | CP1W-TS102 |
|                          |  | 4CH            | ---     | ---   | ---  | Sensor type: Thermocouple (J or K)<br>2channels can be used as analog input.<br>Input range: 1 to 5 V, 0 to 10 V, 4-20 mA | Resolution: 1/12000 | 0.070      | 0.030      |
| 0.080                    |  |                |         |   |  |   | 0.050               | CP1W-TS004 |            |



**I/O Connecting Cable**

| Product name         | Specifications   | Model      |
|----------------------|--|------------|
| I/O Connecting Cable | 80 cm (for CP1W Expansion I/O Units and Expansion Units)<br>Only one I/O Connecting Cable can be used in each PLC. | CP1W-CN811 |



### Recommended Ethernet Communications Cables

For the Ethernet communications cable specifications, refer to page 26.

| Item   |   | Recommended manufacturer | Cable length (m) | Model                |
|--|---|--------------------------|------------------|----------------------|
| Wire Gauge and Number of Pairs:<br>AWG26, 4-pair Cable<br>Cable Sheath material: LSZH *2 | Cable with Connectors on Both Ends (RJ45/RJ45)<br>Standard RJ45 plug type *1<br>Cable color: Yellow *3<br> | OMRON                    | 0.3              | XS6W-6LSZH8SS30CM-Y  |
|  |   |                          | 0.5              | XS6W-6LSZH8SS50CM-Y  |
|  |   |                          | 1                | XS6W-6LSZH8SS100CM-Y |
|  |   |                          | 2                | XS6W-6LSZH8SS200CM-Y |
|  |   |                          | 3                | XS6W-6LSZH8SS300CM-Y |
|  |   |                          | 5                | XS6W-6LSZH8SS500CM-Y |
| Wire Gauge and Number of Pairs:<br>AWG22, 2-pair cable                                   | Cable with Connectors on Both Ends (RJ45/RJ45)<br>Rugged RJ45 plug type *1<br>Cable color: Light blue<br>  | OMRON                    | 0.3              | XS5W-T421-AMD-K      |
|  |   |                          | 0.5              | XS5W-T421-BMD-K      |
|  |   |                          | 1                | XS5W-T421-CMD-K      |
|  |   |                          | 2                | XS5W-T421-DMD-K      |
|  |   |                          | 5                | XS5W-T421-GMD-K      |
|  |   |                          | 10               | XS5W-T421-JMD-K      |

- \*1. Cables with standard RJ45 plugs are available in the following lengths: 0.2 m, 0.3 m, 0.5 m, 1 m, 1.5 m, 2 m, 3 m, 5 m, 7.5 m, 10 m, 15 m, 20 m. Cables with rugged RJ45 plugs are available in the following lengths: 0.3 m, 0.5 m, 1 m, 2 m, 3 m, 5 m, 10 m, 15 m.
- \*2. The lineup features Low Smoke Zero Halogen cables for in-cabinet use and PUR cables for out-of-cabinet use. Although the LSZH cable is single shielded, its communications and noise characteristics meet the standards.
- \*3. Cable colors are available in yellow, green, and blue.
- \*4. For details, contact your OMRON representative.

### RS-232C Connecting Cable

| Name                       | Specifications   | Model       |             |
|----------------------------|--|-------------|-------------|
| PT-to-PLC Connecting Cable | Connection cable with programmable terminal NB / NS<br>For CP2E-N+CP1W-CIF01                 | Length: 2 m | XW2Z-200T   |
|                            |  | Length: 5 m | XW2Z-500T   |
|                            | Connection cable with programmable terminal NB / NS<br>For CP2E-S/E, CP2E-N+CP2W-CIFD1/CIFD2 | Length: 2 m | XW2Z-200T-3 |
|                            |  | Length: 5 m | XW2Z-500T-3 |

### DIN Track Accessories

| Name      | Specifications                                  | Model     |
|-----------|---|-----------|
| DIN Track | Length: 0.5 m; Height: 7.3 mm                   | PFP-50N   |
|           | Length: 1 m; Height: 7.3 mm                     | PFP-100N  |
|           | Length: 1 m; Height: 16 mm                      | PFP-100N2 |
| End Plate | A stopper to secure the Units on the DIN Track. | PFP-M     |

### Programming Devices

#### Software

| Product name   | Specifications   |                    |       | Model          |
|--|--|--------------------|-------|----------------|
|  |  | Number of licenses | Media |                |
| FA Integrated Tool Package<br>CX-One Lite<br>Ver.4.□     | CX-One Lite is a subset of the complete CX-One package that provides only the Support Software required for micro PLC applications.<br>CX-One Lite runs on the following OS.<br>OS: Windows 7 (32-bit/64-bit version) / Windows 8 (32-bit/64-bit version) / Windows 8.1 (32-bit/64-bit version) / Windows 10 (32-bit/64-bit version)<br>CX-One Lite Ver. 4.□ includes Micro PLC Edition CX-Programmer Ver.9.□. | 1 license          | DVD   | CXONE-LT01D-V4 |
| FA Integrated Tool Package<br>CX-One<br>Package Ver. 4.□ | CX-One is a comprehensive software package that integrates Support Software for OMRON PLCs and components. CX-One runs on the following OS.<br>OS: Windows 7 (32-bit/64-bit version) / Windows 8 (32-bit/64-bit version) / Windows 8.1 (32-bit/64-bit version) / Windows 10 (32-bit/64-bit version)<br>CX-One Ver. 4.□ includes CX-Programmer Ver. 9.□.  | 1 license *1       | DVD   | CXONE-AL01D-V4 |

- Note:** 1. CP2E CPU Units are supported by CX-One version 4.51 or higher and CX-Programmer version 9.72 or higher.
- 2. The CX-One and CX-One Lite cannot be simultaneously installed on the same computer.
- 3. For details, refer to the CX-One Catalog (Cat. No. R134).

\*1. Multi licenses (3, 10, 30, or 50 licenses) and DVD media without licenses are also available for the CX-One.

# CP2E

## General Specifications

| Item                      | AC power supply  | DC power supply  |   |
|---------------------------|--|--|---|
| Model                     | CP2E-□□□□□-A   | CP2E-□□□□□-D   |   |
| Enclosure                 | Mounted in a panel   |  |   |
| Dimensions (H × D × W)    | CPU Unit with 14 or 20 I/O points (CP2E-□14/20D□-□): 90mm *1 × 80mm *2 × 86mm<br>CPU Unit with 30 I/O points (CP2E-□30D□-□): 90mm *1 × 80mm *2 × 130mm<br>CPU Unit with 40 I/O points (CP2E-□40D□-□): 90mm *1 × 80mm *2 × 150mm<br>CPU Unit with 60 I/O points (CP2E-□60D□-□): 90mm *1 × 80mm *2 × 195mm |  |   |
| Weight                    | CPU Unit with 14 I/O points (CP2E-□14D□-□): 335g max.<br>CPU Unit with 20 I/O points (CP2E-□20D□-□): 340g max.<br>CPU Unit with 30 I/O points (CP2E-□30D□-□): 580g max.<br>CPU Unit with 40 I/O points (CP2E-□40D□-□): 640g max.<br>CPU Unit with 60 I/O points (CP2E-□60D□-□): 780g max.                |  |   |
| Electrical specifications | Supply voltage   | 100 to 240 VAC 50/60 Hz  | 24 VDC  |
|                           | Operating voltage range  | 85 to 264 VAC  | 20.4 to 26.4 VDC  |
|                           | Power consumption  | 15 VA/100 VAC max. (CP2E-□14/20D□-A)<br>25 VA/240 VAC max.   | 13W max. (CP2E-□14/20D□-D)                                    |
|                           |  | 50 VA/100 VAC max. (CP2E-□30/40/60D□-A)<br>70 VA/240 VAC max.  | 20W max. (CP2E-□30/40/60D□-D) *4                              |
|                           | Inrush current   | 120 VAC, 20 A for 8 ms max. for cold start at room temperature<br>240 VAC, 40 A for 8 ms max. for cold start at room temperature   | 24 VDC, 30A for 20 ms max. for cold start at room temperature |
|                           | External power supply *3   | Not provided. (CP2E-□14/20D□-A)<br>24 VDC, 300 mA (CP2E-□30/40/60D□-A)   | Not provided.   |
|                           | Insulation resistance  | 20 MΩ min. (at 500 VDC) between the external AC terminals and GR terminals   | Not isolated between primary and secondary DC power supplies  |
|                           | Dielectric strength  | 2,300 VAC 50/60Hz for 1 min between AC external and GR terminals<br>Leakage current: 5 mA max.   | Not isolated between primary and secondary DC power supplies  |
| Power interrupt time      | 10 ms min.   | 2 ms min.  |   |
| Application environment   | Ambient operating temperature  | -20 to 60°C  |   |
|                           | Ambient humidity   | 10% to 90%   |   |
|                           | Atmosphere   | No corrosive gas.  |   |
|                           | Ambient storage temperature  | -20 to 75°C (excluding battery)  |   |
|                           | Altitude   | 2,000 m max.   |   |
|                           | Pollution degree   | 2 or less: Conforms to IEC61010-2-201.   |   |
|                           | Noise resistance   | 2 kV on power supply line (Conforms to IEC61000-4-4.)  |   |
|                           | Overvoltage category   | Category II: Conforms to IEC61010-2-201.   |   |
|                           | EMC immunity level   | Zone B   |   |
|                           | Vibration resistance   | Conforms to IEC60068-2-6.<br>5 to 8.4 Hz with 3.5-mm amplitude, 8.4 to 150 Hz<br>Acceleration of 9.8 m/s <sup>2</sup> for 100 min in X, Y, and Z directions (10 sweeps of 10 min each = 100 min total) |   |
| Shock resistance          | Conforms to IEC60068-2-27.<br>147 m/s <sup>2</sup> , 3 times in X, Y, and Z directions   |  |   |
| Terminal block            | Fixed (not removable)  |  |   |
| Terminal screw size       | M3   |  |   |
| Applicable standards      | Conforms to EC Directives, KC, UL and EAC.   |  |   |
| Grounding method          | Ground to 100Ω or less.  |  |   |

\*1. Total of 110 mm with mounting brackets.

\*2. Excluding cables.

\*3. Use the external power supply to power input devices. Do not use it to drive output devices.

\*4. This is the rated value for the maximum system configuration. Use the following formula to calculate power consumption for CPU Units with DC power.

Formula: DC power consumption = (5V current consumption × 5 V/70% (internal power efficiency) + 24V current consumption) × 1.1 (current fluctuation factor)

The above calculation results show that a DC power supply with a greater capacity is required.

**Note: 1.** The Expansion I/O Units and Expansion Units work under the same conditions as the CPU Units unless otherwise specified.

## Performance Specifications

| Item  |                             | CP2E-E□□□□□□□   | CP2E-S□□□□□□□  | CP2E-N□□□□□□□  |  |
|---|-----------------------------|---|--|--|--|
| Program capacity  |                             | 4K steps  | 8K steps   | 10K steps  |  |
| FB capacity   |                             | 4K steps  | 8K steps   | 10K steps  |  |
| Control method  |                             | Stored program method   |  |  |  |
| I/O control method  |                             | Cyclic scan with immediate refreshing   |  |  |  |
| Program language  |                             | Ladder diagram  |  |  |  |
| Function blocks   |                             | Maximum number of function block definitions: 64<br>Maximum number of instances: 128<br>Languages usable in function block definitions: Ladder diagrams, structured text (ST)                       |  |  |  |
| Instructions  |                             | Approximately 220   |  |  |  |
| Processing speed  | Overhead processing time    | 0.1 ms  | 0.15 ms  | 0.2 ms   |  |
|   | Instruction execution times | LD 0.23 μs<br>MOV 1.76 μs   |  |  |  |
| Number of CP1W-series Expansion I/O Units and Expansion Units connected |                             | CP2E-□14/20D□□□: None<br>CP2E-□30/40/60D□□□: 3 units  |  |  |  |
| Maximum number of I/O points  |                             | CP2E-□14D□□□: 14<br>CP2E-□20D□□□: 20<br>CP2E-□30D□□□: 150 (30 built in, 40 × 3 expansion)<br>CP2E-□40D□□□: 160 (40 built in, 40 × 3 expansion)<br>CP2E-□60D□□□: 180 (60 built in, 40 × 3 expansion) |  |  |  |
| Built-in input function   | High-speed counters         | High-speed counter mode/maximum frequency   | Incremental Pulse Inputs<br>100 kHz: 2 counters<br>10 kHz: 4 counters<br>Up/Down Inputs<br>100 kHz: 1 counter<br>10 kHz: 1 counter<br>Pulse + Direction Inputs<br>100 kHz: 2 counters<br>Differential Phase Inputs (4x)<br>50 kHz: 1 counter<br>5 kHz: 1 counter | N14/20D□□□<br>Incremental Pulse Inputs<br>100 kHz: 2 counters<br>10 kHz: 4 counters<br>Up/Down Inputs<br>100 kHz: 1 counter<br>10 kHz: 1 counter<br>Pulse + Direction Inputs<br>100 kHz: 2 counters<br>Differential Phase Inputs (4x)<br>50 kHz: 1 counter<br>5 kHz: 1 counter |  |
|   |                             |   |  | Counting mode  | • Linear mode<br>• Ring mode   |
|   |                             |   |  | Count value  | 32 bits  |
|   |                             |   |  | Counter reset modes  | • Phase Z and software reset (excluding increment pulse input)<br>• Software reset |
|   |                             |   |  | Control method   | • Target matching<br>• Range comparison  |
|   | Input interrupts            | 6 inputs  | 8 inputs<br>(6 inputs only for 14 I/O points)  |  |  |
|   | Quick-response inputs       | 6 inputs  | 8 inputs<br>(6 inputs only for 14 I/O points)  |  |  |
|   | Normal input                | Input constants   | Delays can be set in the PLC setup (0 to 32 ms, default: 8 ms).<br>Set values: 0, 1, 2, 4, 8, 16, or 32 ms   |  |  |

| Item                     |  | CP2E-E□□□□□□□  | CP2E-S□□□□□□□                                       | CP2E-N□□□□□□□  |   |
|--------------------------|--|--|---|--|---|
| Built-in output function | Pulse outputs (Models with transistor outputs only)  | Pulse output   | Pulse output function not included                  | Pulse + Direction Mode   |   |
|                          |  | Frequency  |   | 1 Hz to 100kHz : 2 outputs   | N14/20D□□□□<br>1 Hz to 100kHz: 2 outputs<br>N30/40/60D□□□□<br>1 Hz to 100kHz: 4 outputs                                 |
|                          |  | Output mode  |   | <ul style="list-style-type: none"> <li>Continuous mode (for speed control)</li> <li>Independent mode (for position control)</li> </ul>   |   |
|                          |  | Number of output pulses  |   | <ul style="list-style-type: none"> <li>Relative coordinates: 0000 0000 to 7FFF FFFF hex (0 to 2147483647)</li> <li>Absolute coordinates: 8000 0000 to 7FFF FFFF hex (-2147483647 to 2147483647)</li> </ul> |   |
|                          |  | Acceleration/ deceleration curves  |   | Trapezoidal acceleration and deceleration (Cannot perform S-curve acceleration and deceleration).  |   |
|                          |  | Changing SVs during instruction execution  |   | Only target position can be changed.   |   |
|                          |  | Origin searches  |   | Included   |   |
|                          | Linear interpolation   | None   |   | N14/20D□□□□<br>2 axes max.<br>N30/40/60D□□□□<br>4 axes max.  |   |
|                          | PWM output (transistor outputs models only)  | Frequency  |   | PWM output function not included   | 2.0 to 6,553.5 Hz (in increments of 0.1 Hz) with 1 output or 2 Hz to 32,000 Hz (in increments of 1 Hz) with 1 output    |
|                          |  | Duty factor  |   |  | 0.0% to 100.0% (in increments of 0.1%)<br>Accuracy: +1%/-0% at 2 Hz to 10,000 Hz and +5%/-0% at 10,000 Hz to 32,000 kHz |
| Output mode              |  | Continuous Mode  |   |  |   |
| Communications           | Peripheral USB port  | Conforming to USB 2.0 B-type connector   |   | None   |   |
|                          |  | Transmission distance  | 5 m max.  |  |   |
|                          | Built-in RS232C port   | Interface: Conforming to EIA RS-232C   |   | None   |   |
|                          |  | Transmission distance  | 15 m max.   |  |   |
|                          |  | Communications method  | Half duplex   |  |   |
|                          |  | Synchronization  | Start-stop  |  |   |
|                          |  | Baud rate  | 1.2, 2.4, 4.8, 9.6, 19.2, 38.4, 57.6, or 115.2 kbps |  |   |
|                          | Supported protocol   | <ul style="list-style-type: none"> <li>Host Link</li> <li>1:N NT Link</li> <li>No-protocol mode</li> <li>Serial PLC Links (master, slave)</li> <li>Modbus-RTU Easy Master</li> <li>Modbus-RTU Slave</li> </ul> |   |  |   |
|                          | Built-in RS485 port (not isolated)   | Interface: Conforming to EIA RS-485  |   | None   |   |
|                          |  | Transmission distance  | 50 m max.   |  |   |
| Communications method    |  | Half duplex  |   |  |   |
| Synchronization          |  | Start-stop   |   |  |   |
| Baud rate                |  | 1.2, 2.4, 4.8, 9.6, 19.2, 38.4, 57.6, or 115.2 kbps  |   |  |   |
| Supported protocol       | <ul style="list-style-type: none"> <li>Host Link</li> <li>1:N NT Link</li> <li>No-protocol mode</li> <li>Serial PLC Links (master, slave)</li> <li>Modbus-RTU Easy Master</li> <li>Modbus-RTU Slave</li> </ul> |  |   |  |   |

| Item           |                      | CP2E-E□□□□□□□   | CP2E-S□□□□□□□ | CP2E-N□□□□□□□  |
|----------------|----------------------|---|---------------|--|
| Communications | Serial Option port   | Number of Option Boards   | None          | N14/20D□□□<br>1 Option Board<br>N30/40/60D□□□□<br>2 Option Boards  |
|                |                      | Number of serial communications   |               | N14/20D□□□<br>2 ports max.<br>N30/40/60D□□□□<br>3 ports max.   |
|                |                      | Communications method   |               | Depends on Option Board  |
|                |                      | Synchronization   |               | Depends on Option Board  |
|                |                      | Baud rate   |               | 1.2, 2.4, 4.8, 9.6, 19.2, 38.4, 57.6, or 115.2 kbps  |
|                |                      | Mountable Option Boards   |               | Serial Communication Option Board with one port <ul style="list-style-type: none"> <li>• One RS-232C port: CP1W-CIF01 (Start-stop)</li> <li>• One RS-422A/485 port (not isolated): CP1W-CIF11 (Start-stop)</li> <li>• One RS-422A/485 port (isolated): CP1W-CIF12-V1 (Start-stop)</li> </ul> Serial Communication Option Board with two ports *1 <ul style="list-style-type: none"> <li>• Two RS-232C ports: CP2W-CIFD1 (Start-stop)</li> <li>• One RS-232C port and one RS-485 port (isolated): CP2W-CIFD2 (Start-stop)</li> <li>• Two RS-485 ports (isolated): CP2W-CIFD3 (Start-stop)</li> </ul> Analog Option Board *2<br>CP1W-MAB221/ADB21/DAB21V <p>*1. CP2W-CIFD□□ can only be mounted on option slot 1.<br/>*2. Maximum one Analog Option Board can be mounted on an N□□□-type CPU Unit.</p> |
|                | Compatible protocols | <ul style="list-style-type: none"> <li>• Host Link*</li> <li>• 1:N NT Link*</li> <li>• No-protocol mode</li> <li>• Serial PLC Links (master, slave)</li> <li>• Modbus-RTU Easy Master</li> <li>• Modbus-RTU Slave</li> </ul> * PORT1 (EX) is not supported. |               |  |
|                | Ethernet             | Physical layer  | None          | 100/10BASE-TX (Auto-MDIX)  |
|                |                      | Media access method   |               | CSMA/CD  |
|                |                      | Modulation  |               | Baseband   |
|                |                      | Baud rate   |               | 100BASE-TX: 100Mbit/s<br>10BASE-T: 10Mbit/s <ul style="list-style-type: none"> <li>• Half/full auto-negotiation for each port</li> <li>• Link speed auto-sensing for each port</li> </ul>  |
|                |                      | Transmission media  |               | 100BASE-TX <ul style="list-style-type: none"> <li>• Unshielded twisted-pair (UDP) cable Categories: 5, 5e</li> <li>• Shielded twisted-pair (STP) cable Categories: 100Ω at 5, 5e</li> </ul> 10BASE-T <ul style="list-style-type: none"> <li>• Unshielded twisted-pair (UDP) cable Categories: 3, 4, 5, 5e</li> <li>• Shielded twisted-pair (STP) cable Categories: 100Ω at 3, 4, 5, 5e</li> </ul>  |
|                |                      | Transmission distance   |               | 100 m (distance between switch and node)   |
|                |                      | Protocol  |               | TCP, UDP, APR, ICMP (ping only), SNMP, DNS   |
|                |                      | Applications  |               | FINS, Socket, SNMP, DNS (Client)   |
|                |                      | Number of Ethernet ports  |               | N14/20: 1 port<br>N30/40/60: 2 ports   |
|                | Ethernet switch      | Layer 2 switch<br>* N14/20 is not supported.  |               |  |

| Item  | CP2E-E□□□□□□□   | CP2E-S□□□□□□□  | CP2E-N□□□□□□□  |
|---|---|--|--|
| Number of tasks   | 17<br>• 1 cyclic task<br>• 16 interrupt tasks<br>Scheduled interrupt task: Interrupt task 1 (fixed)<br>Built-in input interrupt task: Interrupt task 2 to 9 (IN8 and IN9 can only be used in N20/30/40/60 CPU Units)<br>High-speed counter interrupt task: Interrupt task 1 to 16   |  |  |
| Maximum subroutine number                                   | 128   |  |  |
| Maximum jump number   | 128   |  |  |
| Scheduled interrupt tasks                                   | 1 interrupt task  |  |  |
| Battery service life<br>*With CP2W-BAT02 Battery (optional) | Battery cannot be mounted.  | CP2W-BAT02 can be mounted.<br>Maximum battery service life: 5 years<br>Guaranteed Lifetime<br>Ambient temperature is 60°C: 13,000 hours (approx. 1.5 years)<br>Ambient temperature is 25°C: 43,000 hours (approx. 5 years) |  |
| Clock   | None  | Supported.<br>Accuracy (monthly deviation):<br>-4.5 min to -0.5 min (ambient temperature: 60°C),<br>-2.0 min to +2.0 min (ambient temperature: 25°C),<br>-2.5 min to +1.5 min (ambient temperature: -20°C)                 |  |
| Memory backup   | Built-in Flash Memory   | Ladder programs and parameters are automatically saved to built-in Flash Memory. A section of the Data Memory Area can be saved to the built-in Flash Memory.  |  |
|   | Built-in non-volatile memory  | Data Memory Area (D), Holding Area (H), Counter Area (C) and Auxiliary Area (A) are automatically saved to the built-in non-volatile memory.   |  |
| CIO Area  | Input Bits  | 1,600 bits (100 words): CIO 0.00 to CIO 99.15 (CIO 00 to CIO 99)   |  |
|   | Output Bits   | 1,600 bits (100 words): CIO 100.00 to CIO 199.15 (CIO 100 to CIO 199)  |  |
|   | Serial PLC Link Words   | 1,440 bits (90 words): CIO 200.00 to CIO 289.15 (CIO 200 to CIO 289)   |  |
| Work Area (W)   | 2,048 bits (128 words): W0.00 to W127.15 (W0 to W127)   |  |  |
| Holding Area (H)  | 2,048 bits (128 words): H0.00 to H127.15 (H0 to 127)<br>Words H512 to H1535: These words can be used only for function blocks.  |  |  |
| Auxiliary Area (A)  | Read-only: 7,168 bits (448 words): A0.00 to A447.15 (A0 to A447)<br>Read/write: 8,192 bits (512 words): A448.00 to A959.15 (A448 to A959)   |  |  |
| Temporary Area (TR)   | 16 bits: TR0 to TR15  |  |  |
| Timer Area (T)  | 256 timer numbers (T0 to T255 (separate from counters))<br>Words T256 to T511: These words can be used only for function blocks.  |  |  |
| Counter Area (C)  | 256 counter numbers (C0 to C255 (separate from timers))<br>Words C256 to C511: These words can be used only for function blocks.  |  |  |
| Data Memory Area (D)  | 4 K words: D0 to D4095<br>DM backup: 1,500 words (D0 to D1499)  | 8 K words: D0 to D8191<br>DM backup: 7,000 words (D0 to D6999)   | 16 K words: D0 to D16383<br>DM backup: 15,000 words (D0 to D14999) |
| Index Registers (IR)  | 16 registers: IR0 to IR15   |  |  |
| Data Registers (DR)   | 16 registers: DR0 to DR15   |  |  |
| Operating modes   | PROGRAM Mode: Program execution is stopped.<br>Preparations can be executed prior to program execution in this mode.<br>MONITOR Mode: Programs are executed.<br>Some operations, such as online editing, and changes to present values in I/O memory, are enabled in this mode.<br>RUN Mode: Programs are executed.<br>This is the normal operating mode. |  |  |

# Internal Memory in the CPU Units

## CPU Unit Memory Backup Structure

The internal memory in the CPU Unit consists of built-in RAM and built-in Flash Memory. The built-in RAM is used as execution memory and the built-in Flash Memory is used as backup memory.

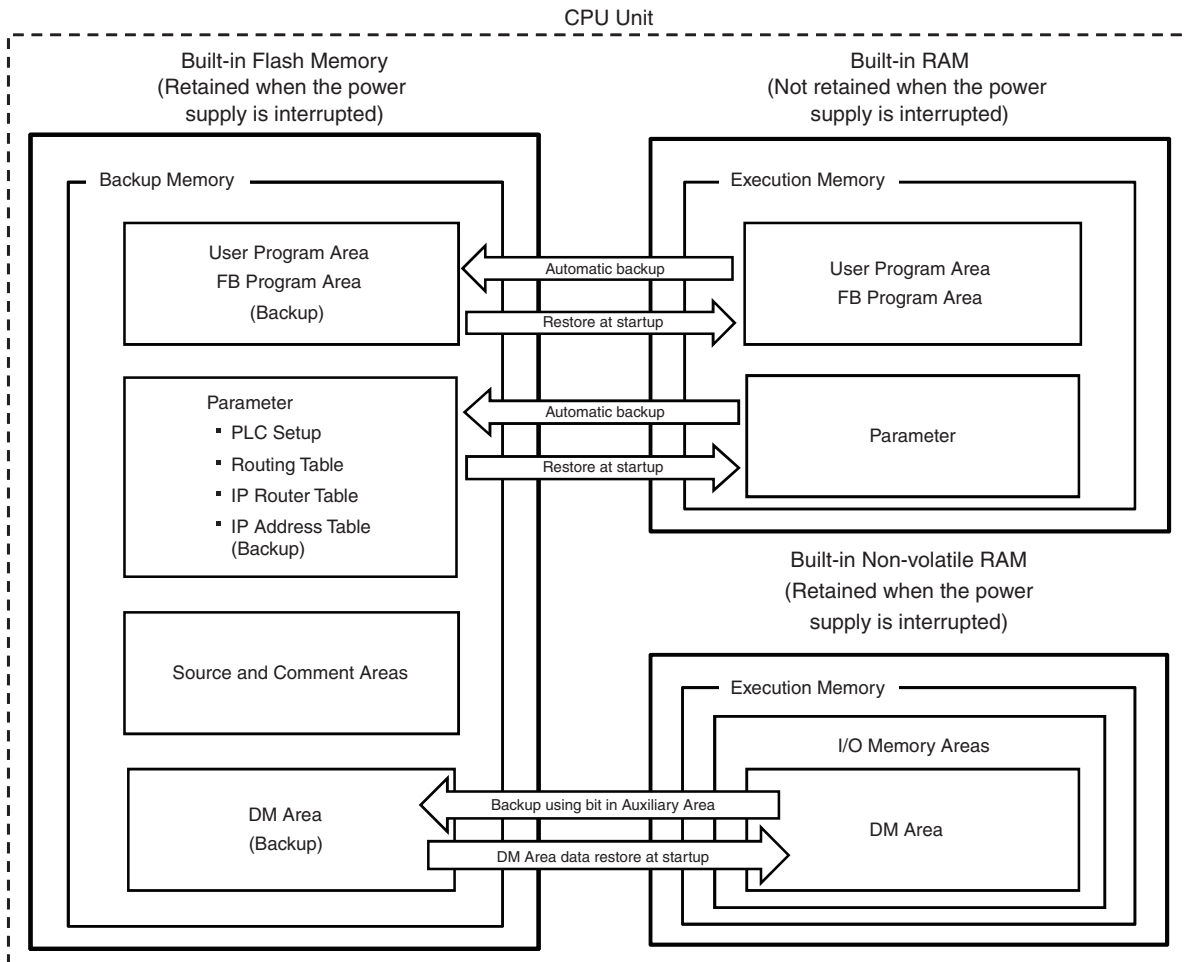

# CP2E

## Part Names and Functions

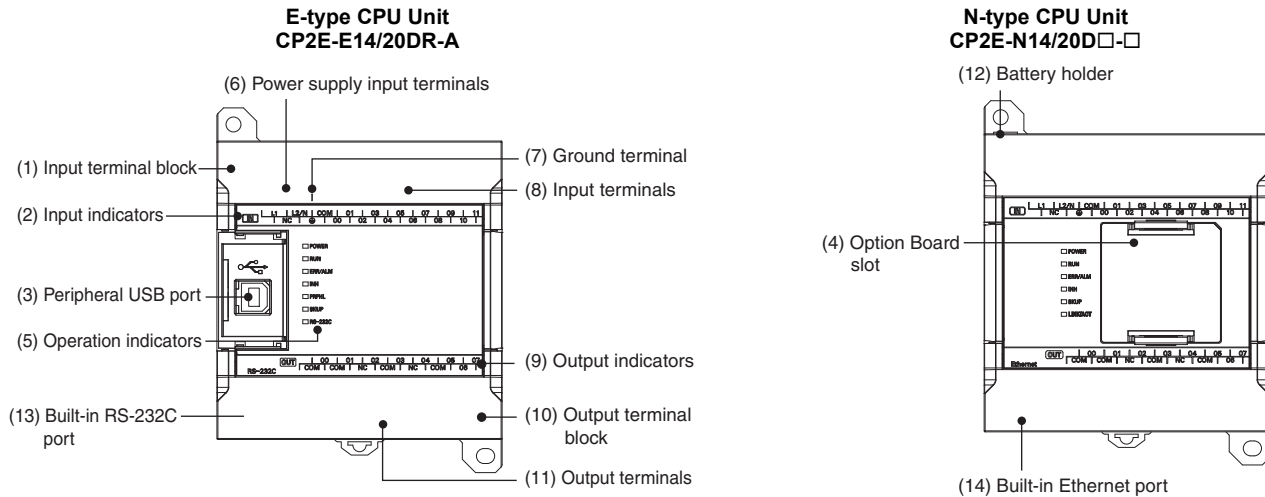

| Number | Name  | Function  |
|--------|---|---|
| (1)    | Input terminal block (not removable)          | This is the terminal block for inputs such as the power supply input and 24 VDC inputs.   |
| (2)    | Input indicators (yellow)                     | Input status is displayed. An indicator will be ON when the input is ON.  |
| (3)    | Peripheral USB port for E□□-type CPU Units    | Used to connect to a personal computer for programming and monitoring by the CX-Programmer for CP2E.  |
| (4)    | Option Board slot for N□□-type CPU Units      | An Option Board can be connected to the slot. <ul style="list-style-type: none"> <li>• CP1W-CIF01 RS-232C Option Board</li> <li>• CP1W-CIF11 RS-422A/485 Option Board (Maximum transmission distance: 50 m)</li> <li>• CP1W-CIF12-V1 RS-422A/485 Option Board (Maximum transmission distance: 500 m)</li> <li>• CP1W-MAB221/ADB21/DAB21V Analog Option Board</li> <li>• CP2W-CIFD1 Option Board with two RS-232C ports</li> <li>• CP2W-CIFD2 Option Board with one RS-232C port and one RS-485 port (isolated)</li> <li>• CP2W-CIFD3 Option Board with two RS-485 ports (isolated)</li> </ul> |
| (5)    | Operation indicators                          | The CPU Unit's operating status can be confirmed with this indicator.   |
| (6)    | Power supply input terminals                  | Power of 100 to 240 VAC or 24 VDC can be supplied.  |
| (7)    | Ground terminal                               | Protective ground (⊕): To prevent electric shock, ground to 100 Ω or less.  |
| (8)    | Input terminals                               | Input devices such as switches and sensors can be connected.  |
| (9)    | Output indicators (yellow)                    | Output status is displayed. An indicator will be ON when the output is ON.  |
| (10)   | Output terminal block (not removable)         | This is the terminal block for outputs such as relay outputs and transistor outputs.  |
| (11)   | Output terminals                              | Loads such as lamps, contactors, and solenoid valves can be connected.  |
| (12)   | Battery holder for N□□-type CPU Units         | A Battery can be installed by opening the cover. (The Battery is optional.)   |
| (13)   | Built-in RS-232C port for E□□-type CPU Units  | By connecting a PT, the controlled system can be monitored and data can be collected.   |
| (14)   | Built-in Ethernet port for N□□-type CPU Units | Used to connect to a personal computer for programming and monitoring by the CX-Programmer for CP2E, or connect to other OMRON PLCs for data exchange.  |



**E/S-type CPU Unit**  
**CP2E-E30/40/60DR-A**  
**CP2E-S30/40/60D□-□**

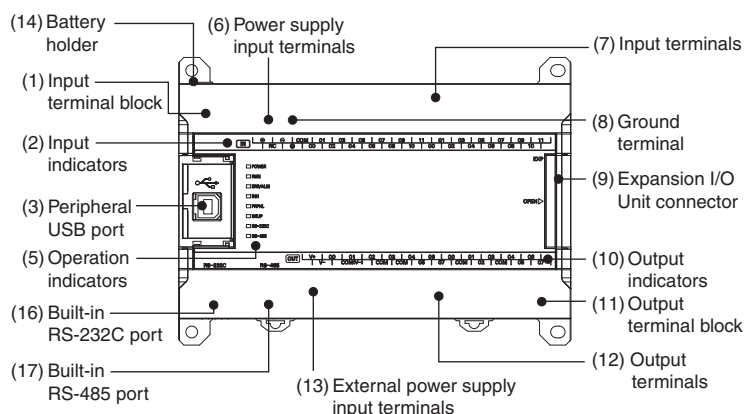

**N-type CPU Unit**  
**CP2E-N30/40/60D□-□**

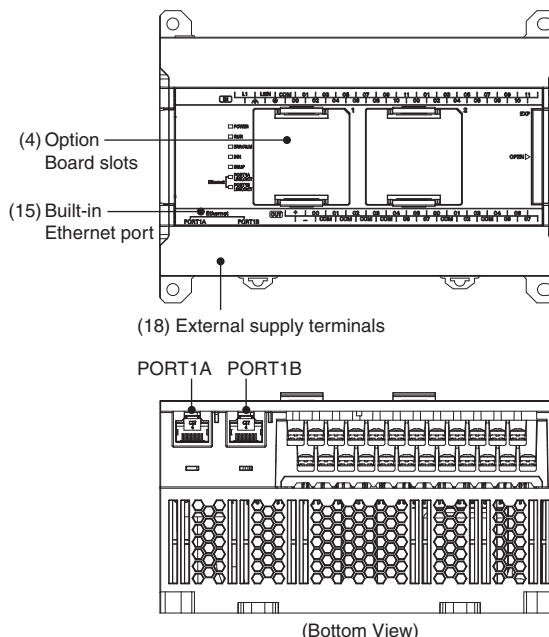

| Number | Name   | Function  |
|--------|--|---|
| (1)    | Input terminal block (not removable)                         | This is the terminal block for inputs such as the power supply input and 24 VDC inputs.   |
| (2)    | Input indicators (yellow)                                    | Input status is displayed. An indicator will be ON when the input is ON.  |
| (3)    | Peripheral USB port for E/S□□-type CPU Units                 | Used to connect to a personal computer for programming and monitoring by the CX-Programmer for CP2E.  |
| (4)    | Option Board slots for N□□-type CPU Units                    | Option Boards can be connected to the slots.<br>• CP1W-CIF01 RS-232C Option Board<br>• CP1W-CIF11 RS-422A/485 Option Board (Maximum transmission distance: 50 m)<br>• CP1W-CIF12-V1 RS-422A/485 Option Board (Maximum transmission distance: 500 m)<br>• CP1W-MAB221/ADB21/DAB21V Analog Option Board<br>• CP2W-CIFD1 Option Board with two RS-232C ports<br>• CP2W-CIFD2 Option Board with one RS-232C port and one RS-485 port (isolated)<br>• CP2W-CIFD3 Option Board with two RS-485 ports (isolated) |
| (5)    | Operation indicators   | The CPU Unit's operating status can be confirmed with this indicator.   |
| (6)    | Power supply input terminals                                 | Power of 100 to 240 VAC or 24 VDC can be supplied.  |
| (7)    | Input terminals  | Input devices such as switches and sensors can be connected.  |
| (8)    | Ground terminal  | Protective ground ( ⊕ ): To prevent electric shock, ground to 100 Ω or less.<br>Functional ground ( ⊕ ): If noise is a significant source of errors or if electrical shock is a problem, connect to the protective ground terminal and ground both with a ground of 100Ω or less (AC power supply only).  |
| (9)    | Expansion I/O Unit connector                                 | CP-series Expansion I/O Units or Expansion Units such as Analog I/O Units, and Temperature Sensor Units can be connected.   |
| (10)   | Output indicators (yellow)                                   | Output status is displayed. An indicator will be ON when the output is ON.  |
| (11)   | Output terminal block (not removable)                        | This is the terminal block for outputs such as relay outputs, transistor outputs, and the external power supply output.   |
| (12)   | Output terminals   | Loads such as lamps, contactors, and solenoid valves can be connected.  |
| (13)   | External power supply input terminals for S□□-type CPU Units | Power of 20.4V to 26.4 VDC can be supplied to CIO 100.00 and CIO 100.01.  |
| (14)   | Battery holder for N/S□□-type CPU Units                      | A Battery can be installed by opening the cover. (Battery is optional.)   |
| (15)   | Built-in Ethernet port for N□□-type CPU Units                | Used to connect to a personal computer for programming and monitoring by the CX-Programmer for CP2E, or connect to other OMRON PLCs for data exchange.  |
| (16)   | Built-in RS-232C port for E/S□□-type CPU Units               | By connecting a PT, the controlled system can be monitored and data can be collected.   |
| (17)   | Built-in RS-485 port for S□□-type CPU Units                  | Communications are possible between an inverter and a PLC by using Modbus-RTU and Serial PLC Links.   |
| (18)   | External supply terminals                                    | The external supply terminals output up to 300 mA max at 24 VDC. They can be used as a service power supply for input devices (AC power supply only).   |

# CP2E

## Built-in Inputs

### Terminal Arrangements

#### ●14 points

##### AC power supply

CP2E-□14D□-A

|       |      |     |    |    |    |    |    |    |  |
|-------|------|-----|----|----|----|----|----|----|--|
| CIO 0 |      |     |    |    |    |    |    |    |  |
| L1    | L2/N | COM | 01 | 03 | 05 | 07 | NC | NC |  |
| NC    | ⊕    | 00  | 02 | 04 | 06 | NC | NC |    |  |

L1,L2/N : Power supply terminal  
 ⊕ : Protective ground terminal  
 COM : Common terminal  
 00 to 07 : Input terminal  
 NC : No connection

##### DC power supply

CP2E-N14D□-D

|       |   |     |    |    |    |    |    |    |  |
|-------|---|-----|----|----|----|----|----|----|--|
| CIO 0 |   |     |    |    |    |    |    |    |  |
| +     | - | COM | 01 | 03 | 05 | 07 | NC | NC |  |
| NC    | ⊕ | 00  | 02 | 04 | 06 | NC | NC |    |  |

+,- : Power supply terminal  
 ⊕ : Protective ground terminal  
 COM : Common terminal  
 00 to 07 : Input terminal  
 NC : No connection

#### ●20 points

##### AC power supply

CP2E-□20D□-A

|       |      |     |    |    |    |    |    |    |  |  |
|-------|------|-----|----|----|----|----|----|----|--|--|
| CIO 0 |      |     |    |    |    |    |    |    |  |  |
| L1    | L2/N | COM | 01 | 03 | 05 | 07 | 09 | 11 |  |  |
| NC    | ⊕    | 00  | 02 | 04 | 06 | 08 | 10 |    |  |  |

L1,L2/N : Power supply terminal  
 ⊕ : Protective ground terminal  
 COM : Common terminal  
 00 to 11 : Input terminal  
 NC : No connection

##### DC power supply

CP2E-N20D□-D

|       |   |     |    |    |    |    |    |    |  |  |
|-------|---|-----|----|----|----|----|----|----|--|--|
| CIO 0 |   |     |    |    |    |    |    |    |  |  |
| +     | - | COM | 01 | 03 | 05 | 07 | 09 | 11 |  |  |
| NC    | ⊕ | 00  | 02 | 04 | 06 | 08 | 10 |    |  |  |

+,- : Power supply terminal  
 ⊕ : Protective ground terminal  
 COM : Common terminal  
 00 to 11 : Input terminal  
 NC : No connection

#### ●30 points

##### AC power supply

CP2E-□30D□-A

|       |      |     |    |    |    |    |    |    |    |       |    |  |  |  |
|-------|------|-----|----|----|----|----|----|----|----|-------|----|--|--|--|
| CIO 0 |      |     |    |    |    |    |    |    |    | CIO 1 |    |  |  |  |
| L1    | L2/N | COM | 01 | 03 | 05 | 07 | 09 | 11 | 01 | 03    | 05 |  |  |  |
| ⊕     | ⊕    | 00  | 02 | 04 | 06 | 08 | 10 | 00 | 02 | 04    | NC |  |  |  |

L1, L2/N : Power supply terminal  
 COM : Common terminal  
 00 to 11 : Input terminal  
 ⊕ : Functional ground terminal  
 ⊕ : Protective ground terminal  
 NC : No connection

##### DC power supply

CP2E-□30D□-D

|       |   |     |    |    |    |    |    |    |    |       |    |  |  |  |
|-------|---|-----|----|----|----|----|----|----|----|-------|----|--|--|--|
| CIO 0 |   |     |    |    |    |    |    |    |    | CIO 1 |    |  |  |  |
| +     | - | COM | 01 | 03 | 05 | 07 | 09 | 11 | 01 | 03    | 05 |  |  |  |
| NC    | ⊕ | 00  | 02 | 04 | 06 | 08 | 10 | 00 | 02 | 04    | NC |  |  |  |

+,- : Power supply terminal  
 COM : Common terminal  
 00 to 11 : Input terminal  
 NC : No connection  
 ⊕ : Protective ground terminal

#### ●40 points

##### AC power supply

CP2E-□40D□-A

|       |      |     |    |    |    |    |    |    |    |       |    |    |    |    |  |  |  |  |  |  |
|-------|------|-----|----|----|----|----|----|----|----|-------|----|----|----|----|--|--|--|--|--|--|
| CIO 0 |      |     |    |    |    |    |    |    |    | CIO 1 |    |    |    |    |  |  |  |  |  |  |
| L1    | L2/N | COM | 01 | 03 | 05 | 07 | 09 | 11 | 01 | 03    | 05 | 07 | 09 | 11 |  |  |  |  |  |  |
| ⊕     | ⊕    | 00  | 02 | 04 | 06 | 08 | 10 | 00 | 02 | 04    | 06 | 08 | 10 |    |  |  |  |  |  |  |

##### DC power supply

CP2E-□40D□-D

|       |   |     |    |    |    |    |    |    |    |       |    |    |    |    |  |  |  |  |  |  |
|-------|---|-----|----|----|----|----|----|----|----|-------|----|----|----|----|--|--|--|--|--|--|
| CIO 0 |   |     |    |    |    |    |    |    |    | CIO 1 |    |    |    |    |  |  |  |  |  |  |
| +     | - | COM | 01 | 03 | 05 | 07 | 09 | 11 | 01 | 03    | 05 | 07 | 09 | 11 |  |  |  |  |  |  |
| NC    | ⊕ | 00  | 02 | 04 | 06 | 08 | 10 | 00 | 02 | 04    | 06 | 08 | 10 |    |  |  |  |  |  |  |

#### ●60 points

##### AC power supply

CP2E-□60D□-A

|       |      |     |    |    |    |    |    |    |    |       |    |    |    |    |    |    |    |    |    |       |  |  |  |  |  |  |  |  |  |  |  |  |  |  |  |  |  |  |  |  |
|-------|------|-----|----|----|----|----|----|----|----|-------|----|----|----|----|----|----|----|----|----|-------|--|--|--|--|--|--|--|--|--|--|--|--|--|--|--|--|--|--|--|--|
| CIO 0 |      |     |    |    |    |    |    |    |    | CIO 1 |    |    |    |    |    |    |    |    |    | CIO 2 |  |  |  |  |  |  |  |  |  |  |  |  |  |  |  |  |  |  |  |  |
| L1    | L2/N | COM | 01 | 03 | 05 | 07 | 09 | 11 | 01 | 03    | 05 | 07 | 09 | 11 | 01 | 03 | 05 | 07 | 09 | 11    |  |  |  |  |  |  |  |  |  |  |  |  |  |  |  |  |  |  |  |  |
| ⊕     | ⊕    | 00  | 02 | 04 | 06 | 08 | 10 | 00 | 02 | 04    | 06 | 08 | 10 | 00 | 02 | 04 | 06 | 08 | 10 |       |  |  |  |  |  |  |  |  |  |  |  |  |  |  |  |  |  |  |  |  |

##### DC power supply

CP2E-□60D□-D

|       |   |     |    |    |    |    |    |    |    |       |    |    |    |    |    |    |    |    |    |       |  |  |  |  |  |  |  |  |  |  |  |  |  |  |  |  |  |  |  |  |
|-------|---|-----|----|----|----|----|----|----|----|-------|----|----|----|----|----|----|----|----|----|-------|--|--|--|--|--|--|--|--|--|--|--|--|--|--|--|--|--|--|--|--|
| CIO 0 |   |     |    |    |    |    |    |    |    | CIO 1 |    |    |    |    |    |    |    |    |    | CIO 2 |  |  |  |  |  |  |  |  |  |  |  |  |  |  |  |  |  |  |  |  |
| +     | - | COM | 01 | 03 | 05 | 07 | 09 | 11 | 01 | 03    | 05 | 07 | 09 | 11 | 01 | 03 | 05 | 07 | 09 | 11    |  |  |  |  |  |  |  |  |  |  |  |  |  |  |  |  |  |  |  |  |
| NC    | ⊕ | 00  | 02 | 04 | 06 | 08 | 10 | 00 | 02 | 04    | 06 | 08 | 10 | 00 | 02 | 04 | 06 | 08 | 10 |       |  |  |  |  |  |  |  |  |  |  |  |  |  |  |  |  |  |  |  |  |

## Allocating Built-in Input Terminals to Functions

Input terminals are allocated functions by setting parameters in the PLC Setup. Set the PLC Setup so that each terminal is used for only one function.

### E20/30/40/60, S30/40/60 or N20/30/40/60 CPU Units

| Terminal block label | Terminal number | PLC Setup   |                      |                           |   |                                   |                        |  |
|----------------------|-----------------|---|----------------------|---------------------------|---|-----------------------------------|------------------------|--|
|                      |                 | Interrupt input settings on Built-in Input Tab Page |                      |                           | High-speed counter 0 to 5 settings on Built-in Input Tab Page |                                   |                        | Origin search settings on Pulse Output 0 to 3 Tab Page |
|                      |                 | Normal  | Interrupt            | Quick                     | Use   |                                   |                        | Use  |
|                      |                 | Normal input  | Interrupt inputs     | Quick-response inputs     | Increment pulse input   | Differential phase ×4 or up/down  | Pulse/direction        | Origin search  |
| CIO 0                | 00              | Normal input 0                                      | ---                  | ---                       | Counter 0, increment input                                    | Counter 0, phase A or up input    | Counter 0, pulse input | ---  |
|                      | 01              | Normal input 1                                      | ---                  | ---                       | Counter 1, increment input                                    | Counter 0, phase B or down input  | Counter 1, pulse input | ---  |
|                      | 02              | Normal input 2                                      | Interrupt input 2    | Quick-response input 2    | Counter 2, increment input                                    | Counter 1, phase A or up input    | Counter 0, direction   | ---  |
|                      | 03              | Normal input 3                                      | Interrupt input 3    | Quick-response input 3    | ---   | Counter 1, phase B or down input  | Counter 1, direction   | ---  |
|                      | 04              | Normal input 4                                      | Interrupt input 4    | Quick-response input 4    | Counter 3, increment input                                    | Counter 0, phase Z or reset input | Counter 0, reset input | ---  |
|                      | 05              | Normal input 5                                      | Interrupt input 5    | Quick-response input 5    | Counter 4, increment input                                    | Counter 1, phase Z or reset input | Counter 1, reset input | ---  |
|                      | 06              | Normal input 6                                      | Interrupt input 6    | Quick-response input 6    | Counter 5, increment input                                    | ---                               | ---                    | Pulse 0, Origin input signal                           |
|                      | 07              | Normal input 7                                      | Interrupt input 7    | Quick-response input 7    | ---   | ---                               | ---                    | Pulse 1, Origin input signal                           |
|                      | 08              | Normal input 8                                      | Interrupt input 8 *1 | Quick-response input 8 *1 | ---   | ---                               | ---                    | Pulse 2, Origin input signal *2                        |
|                      | 09              | Normal input 9                                      | Interrupt input 9 *1 | Quick-response input 9 *1 | ---   | ---                               | ---                    | Pulse 3, Origin input signal *2                        |
|                      | 10              | Normal input 10                                     | ---                  | ---                       | ---   | ---                               | ---                    | Pulse 0, Origin proximity input signal                 |
|                      | 11              | Normal input 11                                     | ---                  | ---                       | ---   | ---                               | ---                    | Pulse 1, Origin proximity input signal                 |
| CIO 1                | 00              | Normal input 12                                     | ---                  | ---                       | ---   | ---                               | ---                    | Pulse 2, Origin proximity input signal *2              |
|                      | 01              | Normal input 13                                     | ---                  | ---                       | ---   | ---                               | ---                    | Pulse 3, Origin proximity input signal *2              |
|                      | 02 to 11        | Normal input 14 to 23                               | ---                  | ---                       | ---   | ---                               | ---                    | ---  |
| CIO 2                | 00 to 11        | Normal input 24 to 35                               | ---                  | ---                       | ---   | ---                               | ---                    | ---  |

\*1. Only supported by N□□-type CPU Units.

\*2. Only supported by N30/40/60 CPU Units.

**Note: 1.** The same pulse inputs must be used for high-speed counter 0 and high-speed counter 1.

**2.** High-speed counter 2 cannot be used if the input setting of high-speed counter 0 or high-speed counter 1 is set for differential phase inputs (4×), pulse + direction inputs, or up/down pulse inputs.

### E14 or N14 CPU Units

| Terminal block label | Terminal number | PLC Setup   |                   |                        |   |                                   |                        |   |
|----------------------|-----------------|---|-------------------|------------------------|---|-----------------------------------|------------------------|---|
|                      |                 | Interrupt input settings on Built-in Input Tab Page |                   |                        | High-speed counter 0 to 5 settings on Built-in Input Tab Page |                                   |                        | Origin search settings on Pulse Output 0/1 Tab Page |
|                      |                 | Normal  | Interrupt         | Quick                  | Use   |                                   |                        | Use   |
|                      |                 | Normal input  | Interrupt inputs  | Quick-response inputs  | Increment pulse input   | Differential phase ×4 or up/down  | Pulse/direction        | Origin search                                       |
| CIO 0                | 00              | Normal input 0                                      | ---               | ---                    | Counter 0, increment input                                    | Counter 0, phase A or up input    | Counter 0, pulse input | ---   |
|                      | 01              | Normal input 1                                      | ---               | ---                    | Counter 1, increment input                                    | Counter 0, phase B or down input  | Counter 1, pulse input | ---   |
|                      | 02              | Normal input 2                                      | Interrupt input 2 | Quick-response input 2 | Counter 2, increment input                                    | Counter 1, phase A or up input    | Counter 0, direction   | ---   |
|                      | 03              | Normal input 3                                      | Interrupt input 3 | Quick-response input 3 | ---   | Counter 1, phase B or down input  | Counter 1, direction   | Pulse 0, Origin proximity input signal              |
|                      | 04              | Normal input 4                                      | Interrupt input 4 | Quick-response input 4 | Counter 3, increment input                                    | Counter 0, Phase Z or reset input | Counter 0, reset input | ---   |
|                      | 05              | Normal input 5                                      | Interrupt input 5 | Quick-response input 5 | Counter 4, increment input                                    | Counter 1, Phase Z or reset input | Counter 1, reset input | Pulse 1, Origin proximity input signal              |
|                      | 06              | Normal input 6                                      | Interrupt input 6 | Quick-response input 6 | Counter 5, increment input                                    | ---                               | ---                    | Pulse 0, Origin input signal                        |
|                      | 07              | Normal input 7                                      | Interrupt input 7 | Quick-response input 7 | ---   | ---                               | ---                    | Pulse 1, Origin input signal                        |

**Note: 1.** The same pulse inputs must be used for high-speed counter 0 and high-speed counter 1.

**2.** High-speed counter 2 cannot be used if the input setting of high-speed counter 0 or high-speed counter 1 is set for differential phase inputs (4×), pulse + direction inputs, or up/down pulse inputs.

# CP2E

## Built-in Outputs

### Terminal Arrangements

#### ●14 points

##### AC/DC power supply

CP2E-□14D□-□

|     |     |    |     |    |     |    |
|-----|-----|----|-----|----|-----|----|
| 00  | 01  | 02 | 03  | 04 | 05  | NC |
| COM | COM | NC | COM | NC | COM | NC |

CIO 100

COM : Common terminal  
00 to 05 : Output terminal  
NC : No connection

#### ●20 points

##### AC/DC power supply

CP2E-□20D□-□

|     |     |    |     |    |     |    |
|-----|-----|----|-----|----|-----|----|
| 00  | 01  | 02 | 03  | 04 | 05  | 07 |
| COM | COM | NC | COM | NC | COM | 06 |

CIO 100

COM : Common terminal  
00 to 07 : Output terminal  
NC : No connection

#### ●30 points

##### AC power supply

CP2E-□30D□-A

|   |     |     |     |    |     |    |     |    |    |
|---|-----|-----|-----|----|-----|----|-----|----|----|
| + | 00  | 01  | 02  | 04 | 05  | 07 | 00  | 02 |    |
| - | COM | COM | COM | 03 | COM | 06 | COM | 01 | 03 |

CIO 100

CIO 101

+, - : External supply terminal  
COM : Common terminal  
00 to 07 : Output terminal

##### DC power supply

CP2E-N30D□-D

|    |     |     |     |    |     |    |     |    |    |
|----|-----|-----|-----|----|-----|----|-----|----|----|
| NC | 00  | 01  | 02  | 04 | 05  | 07 | 00  | 02 |    |
| NC | COM | COM | COM | 03 | COM | 06 | COM | 01 | 03 |

CIO 100

CIO 101

NC : No connection  
COM : Common terminal  
00 to 07 : Output terminal

CP2E-S30DT-D

|    |         |     |    |     |    |     |    |    |
|----|---------|-----|----|-----|----|-----|----|----|
| V+ | 00      | 01  | 02 | 04  | 05 | 07  | 00 | 02 |
| V- | COM(V-) | COM | 03 | COM | 06 | COM | 01 | 03 |

CIO 100

CIO 101

COM : Common terminal  
00-07 : Output terminal  
V+ : External power supply input terminal for CIO 100.00/01 (DC24V)  
V- : External power supply input terminal for CIO 100.00/01 (0V)

**Note:** COM(V-) has been connected with V- in an inner circuit.

CP2E-S30DT1-D

|    |         |     |    |     |    |     |    |    |
|----|---------|-----|----|-----|----|-----|----|----|
| V+ | 00      | 01  | 02 | 04  | 05 | 07  | 00 | 02 |
| V- | COM(V+) | COM | 03 | COM | 06 | COM | 01 | 03 |

CIO 100

CIO 101

**Note:** COM(V+) has been connected with V+ in an inner circuit.

#### ●40 points

##### AC power supply

CP2E-□40D□-A

|   |     |     |     |     |    |    |     |    |     |    |    |
|---|-----|-----|-----|-----|----|----|-----|----|-----|----|----|
| + | 00  | 01  | 02  | 03  | 04 | 06 | 00  | 01 | 03  | 04 | 06 |
| - | COM | COM | COM | COM | 05 | 07 | COM | 02 | COM | 05 | 07 |

CIO 100

CIO 101

##### DC power supply

CP2E-N40D□-D

|    |     |     |     |     |    |    |     |    |     |    |    |
|----|-----|-----|-----|-----|----|----|-----|----|-----|----|----|
| NC | 00  | 01  | 02  | 03  | 04 | 06 | 00  | 01 | 03  | 04 | 06 |
| NC | COM | COM | COM | COM | 05 | 07 | COM | 02 | COM | 05 | 07 |

CIO 100

CIO 101

CP2E-S40DT-D

|    |         |     |     |    |    |     |    |     |    |    |    |
|----|---------|-----|-----|----|----|-----|----|-----|----|----|----|
| V+ | 00      | 01  | 02  | 03 | 04 | 06  | 00 | 01  | 03 | 04 | 06 |
| V- | COM(V-) | COM | COM | 05 | 07 | COM | 02 | COM | 05 | 07 |    |

CIO 100

CIO 101

**Note:** COM(V-) has been connected with V- in an inner circuit.

CP2E-S40DT1-D

|    |         |     |     |    |    |     |    |     |    |    |    |
|----|---------|-----|-----|----|----|-----|----|-----|----|----|----|
| V+ | 00      | 01  | 02  | 03 | 04 | 06  | 00 | 01  | 03 | 04 | 06 |
| V- | COM(V+) | COM | COM | 05 | 07 | COM | 02 | COM | 05 | 07 |    |

CIO 100

CIO 101

**Note:** COM(V+) has been connected with V+ in an inner circuit.

●60 points

AC power supply

CP2E-□60D□-A

|         |     |     |     |         |     |    |     |         |    |     |    |     |    |    |     |    |
|---------|-----|-----|-----|---------|-----|----|-----|---------|----|-----|----|-----|----|----|-----|----|
| +       | 00  | 01  | 02  | 04      | 05  | 07 | 00  | 02      | 04 | 05  | 07 | 00  | 02 | 04 | 05  | 07 |
| -       | COM | COM | COM | 03      | COM | 06 | COM | 01      | 03 | COM | 06 | COM | 01 | 03 | COM | 06 |
| CIO 100 |     |     |     | CIO 101 |     |    |     | CIO 102 |    |     |    |     |    |    |     |    |

DC power supply

CP2E-N60D□-D

|         |     |     |     |         |     |    |     |         |    |     |    |     |    |    |     |    |
|---------|-----|-----|-----|---------|-----|----|-----|---------|----|-----|----|-----|----|----|-----|----|
| NC      | 00  | 01  | 02  | 04      | 05  | 07 | 00  | 02      | 04 | 05  | 07 | 00  | 02 | 04 | 05  | 07 |
| NC      | COM | COM | COM | 03      | COM | 06 | COM | 01      | 03 | COM | 06 | COM | 01 | 03 | COM | 06 |
| CIO 100 |     |     |     | CIO 101 |     |    |     | CIO 102 |    |     |    |     |    |    |     |    |

CP2E-S60DT-D

|         |         |     |    |         |    |     |    |         |     |    |     |    |    |     |    |    |
|---------|---------|-----|----|---------|----|-----|----|---------|-----|----|-----|----|----|-----|----|----|
| V+      | 00      | 01  | 02 | 04      | 05 | 07  | 00 | 02      | 04  | 05 | 07  | 00 | 02 | 04  | 05 | 07 |
| V-      | COM(V-) | COM | 03 | COM     | 06 | COM | 01 | 03      | COM | 06 | COM | 01 | 03 | COM | 06 |    |
| CIO 100 |         |     |    | CIO 101 |    |     |    | CIO 102 |     |    |     |    |    |     |    |    |

Note: COM(V-) has been connected with V- in an inner circuit.

CP2E-S60DT1-D

|         |         |     |    |         |    |     |    |         |     |    |     |    |    |     |    |    |
|---------|---------|-----|----|---------|----|-----|----|---------|-----|----|-----|----|----|-----|----|----|
| V+      | 00      | 01  | 02 | 04      | 05 | 07  | 00 | 02      | 04  | 05 | 07  | 00 | 02 | 04  | 05 | 07 |
| V-      | COM(V+) | COM | 03 | COM     | 06 | COM | 01 | 03      | COM | 06 | COM | 01 | 03 | COM | 06 |    |
| CIO 100 |         |     |    | CIO 101 |    |     |    | CIO 102 |     |    |     |    |    |     |    |    |

Note: COM(V+) has been connected with V+ in an inner circuit.

### Allocating Built-in Output Terminals to Functions

Output terminals are allocated functions by setting parameters in the PLC Setup. Set the PLC Setup so that each terminal is used for only one function.

| Output terminal block |                 | Other than those shown at the right | When a pulse output instruction (ITPL, SPED, ACC, PLS2, or ORG) is executed | PLC Setup                              | When the PWM instruction is executed |
|-----------------------|-----------------|-------------------------------------|---|--|--------------------------------------|
| Terminal block label  | Terminal number |                                     |   | Normal outputs                         |                                      |
|                       |                 | Fixed duty ratio pulse output       |   |  | Variable-duty-factor output          |
|                       |                 | Pulse + Direction Mode              |   | Use                                    | PWM output                           |
| CIO 100               | 00              | Normal output 0                     | Pulse output 0, pulse   | ---                                    | ---                                  |
|                       | 01              | Normal output 1                     | Pulse output 1, pulse   | ---                                    | PWM output 0                         |
|                       | 02              | Normal output 2                     | Pulse output 0, direction   | ---                                    | ---                                  |
|                       | 03              | Normal output 3                     | Pulse output 1, direction   | ---                                    | ---                                  |
|                       | 04              | Normal output 4                     | ---   | Pulse 0, Error counter reset output    | ---                                  |
|                       | 05              | Normal output 5                     | ---   | Pulse 1, Error counter reset output    | ---                                  |
|                       | 06              | Normal output 6                     | ---   | Pulse 2, Error counter reset output *1 | ---                                  |
|                       | 07              | Normal output 7                     | ---   | Pulse 3, Error counter reset output *1 | ---                                  |
| CIO 101               | 00              | Normal output 0                     | Pulse output 2, pulse *1  | ---                                    | ---                                  |
|                       | 01              | Normal output 1                     | Pulse output 3, pulse *1  | ---                                    | ---                                  |
|                       | 02              | Normal output 2                     | Pulse output 2, direction *1  | ---                                    | ---                                  |
|                       | 03              | Normal output 3                     | Pulse output 3, direction *1  | ---                                    | ---                                  |
|                       | 04 to 07        | Normal output 12 to 15              | ---   | ---                                    | ---                                  |
| CIO 102               | 00 to 07        | Normal output 16 to 23              | ---   | ---                                    | ---                                  |

\*1. Only supported by N30/40/60 CPU Units.

Specifications

| Item                  |                              | Specification                              |   |  |
|-----------------------|------------------------------|--|---|--|
| Input type            |                              | High-speed counter inputs or normal inputs | High-speed counter inputs, interrupt inputs, quick-response inputs or normal inputs | Normal inputs  |
| Input bits            | E/S□□-type and N14 CPU Units | CIO 0.00 and CIO 0.01                      | CIO 0.02 to CIO 0.07  | CIO 0.08 to CIO 0.11, CIO 1.00 to CIO 1.11 and CIO 2.00 to CIO 2.11 *1 |
|                       | N20 CPU Units                | CIO 0.00 and CIO 0.01                      | CIO 0.02 to CIO 0.09  | CIO 0.10 to CIO 0.11   |
|                       | N30/40/60 CPU Units          | CIO 0.00 to CIO 0.03                       | CIO 0.04 to CIO 0.09  | CIO 0.10, CIO 0.11, CIO 1.00 to CIO 1.11 and CIO 2.00 to CIO 2.11 *1   |
| Applicable inputs     |                              | 2-wire and 3-wire sensors                  |   |  |
| Input voltage         |                              | 24 VDC, +10% / -15%                        |   |  |
| Input impedance       |                              | 3.3 kΩ                                     | 3.3 kΩ  | 4.8 kΩ   |
| Input current         |                              | 7.5 mA (typical)                           | 7.5 mA (typical)  | 5 mA (typical)   |
| ON voltage/current    |                              | 17.0 VDC min. / 3 mA min.                  | 17.0 VDC min. / 3 mA min.   | 14.4 VDC min. / 3 mA min.  |
| OFF voltage/current   |                              | 5.0 VDC max. / 1 mA max.                   | 5.0 VDC max. / 1 mA max.  | 5.0 VDC max. / 1 mA max.   |
| ON response time *2   |                              | 2.5 μs min.                                | 50 μs max.  | 1 ms max.  |
| OFF response time *2  |                              | 2.5 μs min.                                | 50 μs max.  | 1 ms max.  |
| Circuit configuration |                              |  |   |  |

\*1. The bits that can be used depend on the model of CPU Unit.

\*2. The response time is the delay caused by hardware. The delay set in the PLC Setup (0 to 32 ms, default: 8 ms) for a normal input must be added to this value.

- Interrupt input mode
- Pulse plus direction input mode
- Increment mode
- Up/down input mode

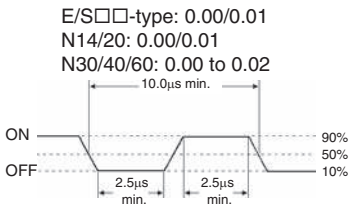

Differential phase mode

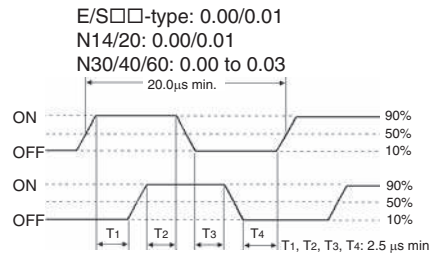

- E/S□□-type: 0.02 to 0.07  
N14: 0.02 to 0.07  
N20: 0.02 to 0.09  
N30/40/60: 0.04 to 0.09

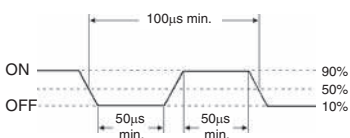

- E/S□□-type: 0.02/0.03  
N14/20: 0.02/0.03

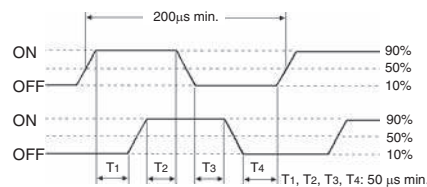

## Output Specifications for Relay Outputs

CP2E-□□□DR-□

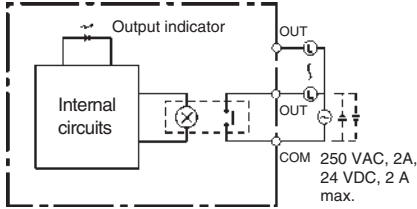
| Item                       |            | Specification  |   |
|----------------------------|------------|--|---|
| Maximum switching capacity |            | 2 A 250 VAC (cosφ= 1)<br>2 A 24 VDC (4 A/common)                                   |   |
| Minimum switching capacity |            | 10 mA 5 VDC  |   |
| Service life of relay      | Electrical | Resistive load   | 200,000 operations (24 VDC)             |
|                            |            | Inductive load   | 70,000 operations (250 VAC, cosφ = 0.4) |
|                            | Mechanical | 20,000,000 operations  |   |
| ON response time           |            | 15 ms max.   |   |
| OFF response time          |            | 15 ms max.   |   |
| Circuit configuration      |            |  |   |

### Estimating the Service Life of Relays

Under normal conditions, the service life of output contacts is as shown above. The service life of relays is as shown in the following diagram as a guideline.

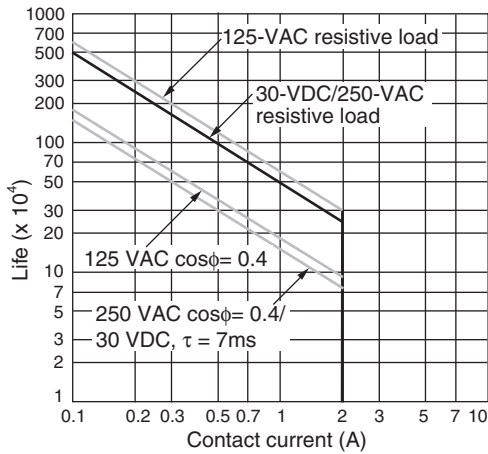

## Output Specifications for Transistor Outputs (Sinking or Sourcing)

CP2E-N14/20/30/40/60DT(1)-□, CP2E-S30/40/60DT(1)-□

### Normal Outputs

| Item                       | Specification  |   |
|----------------------------|--|---|
|                            | S□□-type: CIO 100.00 and CIO 100.01<br>N□□-type: CIO 100.00, CIO 100.01,<br>CIO 101.00 and CIO 101.01  | S□□-type: CIO 100.02 to CIO 102.07 *2<br>N□□-type: CIO 100.02 to CIO 100.07,<br>CIO 101.02 to CIO 102.07 *2 |
| Maximum switching capacity | 0.3 A/output, 0.9 A/common *1<br>4.5 to 30 VDC<br>CP2E-N14D□-□: 1.5 A/Unit      CP2E-S/N40D□-□: 3.6 A/Unit<br>CP2E-N20D□-□: 1.8 A/Unit      CP2E-S/N60D□-□: 5.4 A/Unit<br>CP2E-S/N30D□-□: 2.7 A/Unit |   |
| Minimum switching capacity | 1 mA 4.5 to 30 VDC   |   |
| Leakage current            | 0.1 mA max.  |   |
| Residual voltage           | 0.6 V max.   | 1.5V max.   |
| ON response time           | 0.1 ms max.  | 0.1 ms max.   |
| OFF response time          | 0.1 ms max.  | 1 ms max.   |
| Fuse                       | Not provided.  |   |
| External power supply      | 20.4 to 26.4VDC 30mA max.<br>(N□□-type is not needed)  | Not needed  |
| Circuit configuration      | <p>• S□□-type CPU Unit</p> <p><b>Sinking output model</b></p> <p><b>Sourcing output model</b></p> <p>• N□□-type CPU Unit</p> <p><b>Sinking output model</b></p> <p><b>Sourcing output model</b></p>  |   |

\*1. Also do not exceed 0.9 A for the total of CIO 100.00 to CIO 100.03, which are different common.

\*2. The bits that can be used depend on the model of CPU Unit.

**Note:** 1. Do not connect a load to an output terminal or apply a voltage in excess of the maximum switching capacity.

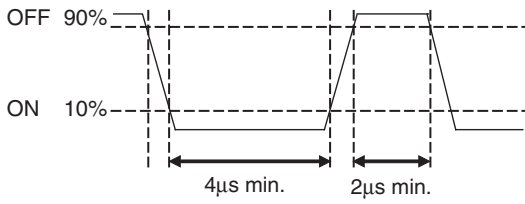

**Pulse Outputs**

| Item                       | Specification  |
|----------------------------|--|
|                            | S□□-type: CIO 100.00 and CIO 100.01<br>N□□-type: CIO 100.00, CIO 100.01, CIO 101.00 and CIO 101.01   |
| Maximum switching capacity | 100 mA 4.5 to 26.4 VDC   |
| Minimum switching capacity | 7 mA 4.5 to 26.4 VDC   |
| Maximum output frequency   | 100 kHz  |
| Output waveform            |  <p>The OFF and ON refer to the output transistor. The output transistor is ON at level "L".</p> |

- Note:**
1. The load for the above values is assumed to be the resistive load, and does not take into account the impedance for the connecting cable to the load.
  2. Due to distortions in pulse waveforms resulting from connecting cable impedance, the pulse widths in actual operation may be smaller than the values shown above.

**PWM Output (CIO 100.01)**

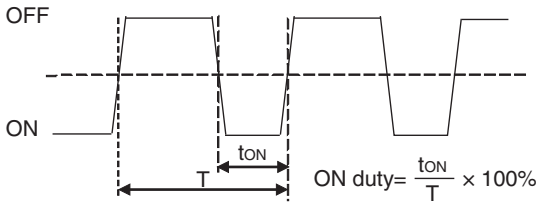
| Item                       | Specification  |
|----------------------------|--|
| Maximum switching capacity | 30 mA 4.5 to 26.4 VDC  |
| Maximum output frequency   | 32 kHz   |
| PWM output accuracy        | For ON duty +1%, -0%: 10 kHz output<br>For ON duty +5%, -0%: 0 to 32 kHz output  |
| Output waveform            |  <p>The OFF and ON refer to the output transistor. The output transistor is ON at level "L".</p> |

# CP2E

## Built-in Ethernet

### General Specifications (Ethernet)

| Item                     |                     | Specifications   |  |
|--------------------------|---------------------|--|--|
| Type                     |                     | 100BASE-TX (Auto-MDIX)   | 10BASE-T (Auto-MDIX)   |
| Number of Ethernet ports |                     | N14/20 CPU Units: 1 port<br>N30/40/60 CPU Units: 2 ports (Switching Hub function is built in.)                                       |  |
| Transfer                 | Media access method | CSMA/CD  |  |
|                          | Modulation method   | Baseband   |  |
|                          | Transmission paths  | Star form  |  |
|                          | Baud rate           | 100 Mbit/s (100Base-TX)<br>Auto-Negotiation<br>• Half/full auto-negotiation for each port<br>• Link speed auto-sensing for each port | 10 Mbit/s (10Base-T)<br>Auto-Negotiation   |
|                          | Transmission media  | • Unshielded twisted-pair (UDP) cable<br>Categories: 5, 5e<br>• Shielded twisted-pair (STP) cable<br>Categories: 100Ω at 5, 5e       | • Unshielded twisted-pair (UDP) cable<br>Categories: 3, 4, 5, 5e<br>• Shielded twisted-pair (STP) cable<br>Categories: 100Ω at 3, 4, 5, 5e |
| Transmission distance    |                     | 100 m (distance between hub and node)  |  |
| Protocols                |                     | TCP, UDP, ARP, ICMP (ping only), SNMP, DNS   |  |

### FINS Communications Service Specifications

| Item   |  | Specification                     |  |
|--|--|-----------------------------------|--|
| Protocol name  |  | FINS/UDP                          | FINS/TCP   |
| Number of nodes  |  | 254                               |  |
| Message Length   |  | 1016 bytes max.                   |  |
| Date Length  |  | 1004 bytes max.                   |  |
| Number of buffer   |  | 16                                |  |
| Protocol used  |  | UDP/IP                            | TCP/IP   |
| The selection of UDP/IP or TCP/IP is made by means of the FINS/UDP or FINS/TCP button in Built-in Ethernet Tab in the CX-Programmer's PLC Setup. |  |                                   |  |
| Number of connections  |  | ---                               | 3 for user, 1 for CX-Programmer auto connection                          |
| Port number  |  | 9600 (default)<br>Can be changed. | 9600 (default)<br>Can be changed.  |
| Protection   |  | No                                | Yes (Specification of client IP addresses when unit is used as a server) |
| Local IP address   |  | 192.168.250.FINS node address     |  |

### Switching Hub for CP2E N□□-type CPU Units

|                              |                      |
|------------------------------|----------------------|
| Ethernet                     | 100Base-TX, 10Base-T |
| Auto MID/MID-X               | Yes                  |
| Auto negotiation             | Yes                  |
| Store-and-forward system     | Yes                  |
| Buffer                       | 32K bytes            |
| MAC address                  | 1000                 |
| Broadcast storm detection    | Yes                  |
| QoS                          | No                   |
| SNMP                         | No                   |
| VLAN                         | No                   |
| IGMP snooping                | No                   |
| STP (Spanning Tree Protocol) | No                   |
| Port mirroring               | No                   |

## Serial Communication

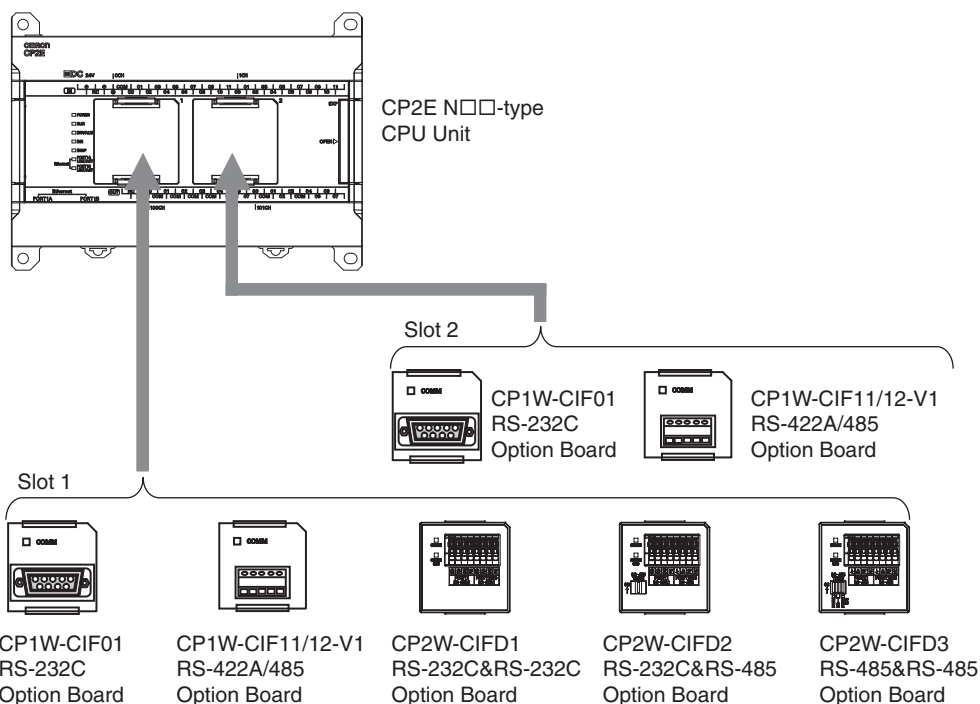

**Note: 1.** CP2W-CIFD□ can only be mounted on option slot 1.

### Serial Communication Option Board

| Model numbers | Port  | Maximum transmission distance  | Connection method               |
|---------------|---|--------------------------------|---------------------------------|
| CP1W-CIF01    | One RS-232C port                                | 15m                            | Connector (D-sub, 9 pin female) |
| CP1W-CIF11    | One RS-422A/485 port (not isolated)             | 50m                            | Terminal block (using ferrules) |
| CP1W-CIF12-V1 | One RS-422A/485 port (isolated)                 | 500m                           | Terminal block (using ferrules) |
| CP2W-CIFD1    | Two RS-232C Ports                               | 15m                            | Terminal block (using ferrules) |
| CP2W-CIFD2    | One RS-232C port and one RS-485 port (isolated) | 15m (RS-232C)<br>500m (RS-485) | Terminal block (using ferrules) |
| CP2W-CIFD3    | Two RS-485 ports (isolated)                     | 500m                           | Terminal block (using ferrules) |

### Built-in RS-232C Port for E/S□□-type CPU Units



| Pin | Abbr.   | Signal Name     | Signal direction |
|-----|---------|-----------------|------------------|
| 1   | SD(TXD) | Send data       | Output           |
| 2   | RD(RXD) | Receive data    | Input            |
| 3   | RS(RTS) | Request to send | Output           |
| 4   | CS(CTS) | Clear to send   | Input            |
| 5   | SG(0V)  | Signal ground   | -                |
| 6   | FG      | Frame ground    | -                |

### Built-in RS-485 Port (2-wire) for S□□-type CPU Units

#### RS-485 Terminal Block



| Pin | Abbr. | Signal Name         | Signal direction |
|-----|-------|---------------------|------------------|
| 1   | A-    | Send/Receive data - | -                |
| 2   | B+    | Send/Receive data + | -                |
| 3   | FG    | Frame ground        | -                |

### DIP Switch for Terminating Resistance Settings

| Setting |     |     | Terminating resistance selection<br>Resistance value: 220 Ω typical |
|---------|-----|-----|---|
| ON↑     | ON  | OFF |   |
|         | OFF | OFF |   |
|         | ON  | OFF |   |

### CP1W-CIF01 RS-232C Option Board

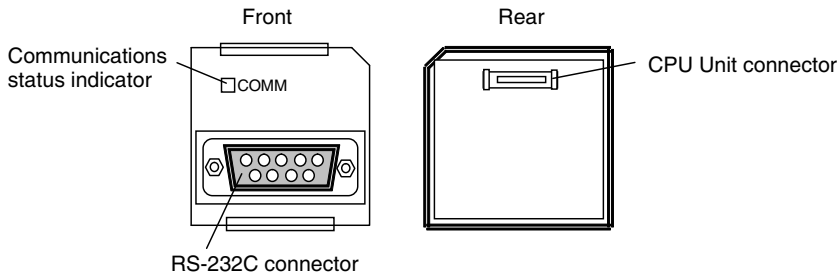

#### RS-232C Connector

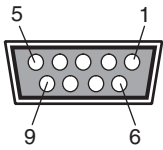

| Pin            | Abbr.   | Signal              | Signal direction |
|----------------|---------|---------------------|------------------|
| 1              | FG      | Frame ground        | -                |
| 2              | SD(TXD) | Send data           | Output           |
| 3              | RD(RXD) | Receive data        | Input            |
| 4              | RS(RTS) | Request to send     | Output           |
| 5              | CS(CTS) | Clear to send       | Input            |
| 6              | 5V      | Power               | -                |
| 7              | DR(DSR) | Data set ready      | Input            |
| 8              | ER(DTR) | Data terminal ready | Output           |
| 9              | SG(0V)  | Signal ground       | -                |
| Connector hood | FG      | Frame ground        | -                |

**Note: 1.** The NV3W-M□20L-V1 Programmable Terminal can be connected to pin 6 (+5V) on the RS-232C Option Board (CP1W-CIF01) mounted to the CPU Unit. Do not connect pin 6 to any other device.

### CP1W-CIF11/CIF12-V1 RS-422A/485 Option Board

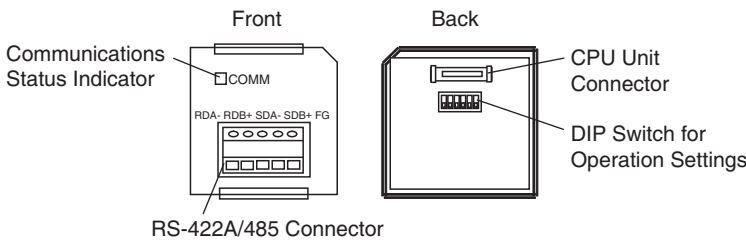

#### RS-422A/485 Terminal Block

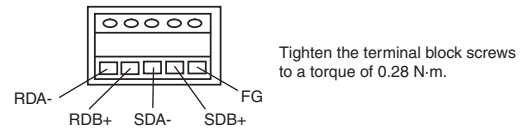

#### DIP Switch for Operation Settings

| CP1W-CIF11 | Pin | CP1W-CIF12-V1 | Pin | Setting                                    |  | Setting  |
|------------|-----|---------------|-----|--|--|--|
|            |     |               |     | ON   | OFF  |  |
|            | 1   | SW1           | 1   | ON   | ON (both ends)                                 | Terminating resistance selection<br>Resistance value: 220Ω typical |
|            |     |               |     | OFF  | OFF  |  |
|            | 2   | 2             | 2   | ON   | 2-wire connections                             | 2-wire or 4-wire selection *1                                      |
|            |     |               |     | OFF  | 4-wire connections                             |  |
|            | 3   | 3             | 3   | ON   | 2-wire connections                             | 2-wire or 4-wire selection *1                                      |
|            |     |               |     | OFF  | 4-wire connections                             |  |
| 4          | 4   | -             | -   | Not used.                                  |  |  |
| 5          | 5   | SW2           | 1   | ON   | RS control enabled                             | RS control selection for RD *2                                     |
|            |     |               |     | OFF  | RS control disabled<br>(Data always received.) |  |
| 6          | 6   | 2             | ON  | RS control enabled                         | RS control selection for SD *3                 |  |
|            |     |               | OFF | RS control disabled<br>(Data always sent.) |  |  |

- \*1. Set both pins 2 and 3 to either ON (2-wire) or OFF (4-wire).
- \*2. To disable the echo-back function, set pin 5 to ON (RS control enabled).
- \*3. When connecting to a device on the N side in a 1: N connection with the 4-wire method, set pin 6 to ON (RS control enabled).  
Also, when connecting by the 2-wire method, set pin 6 to ON (RS control enabled).

## CP2W-CIFD1 RS-232C&RS-232C Option Board

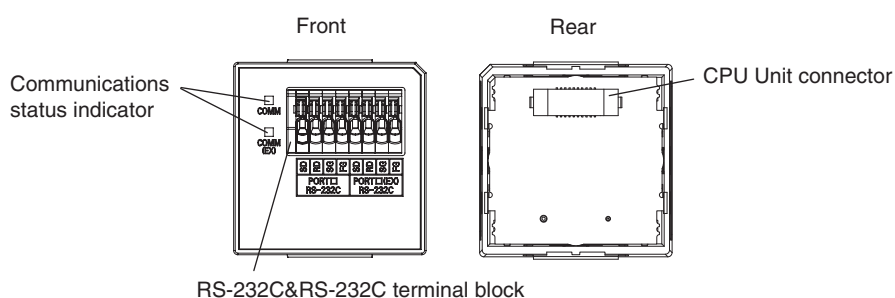

RS-232C&RS-232C terminal block

### RS-232C&RS-232C Terminal Block

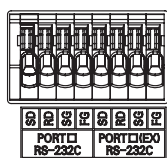

| Port       | Pin | Abbr.   | Signal Name   | Signal direction |
|------------|-----|---------|---------------|------------------|
| PORT□      | 1   | SD(TXD) | Send data     | Output           |
|            | 2   | RD(RXD) | Receive data  | Input            |
|            | 3   | SG(0V)  | Signal ground | ---              |
|            | 4   | FG      | Frame ground  | ---              |
| PORT□ (EX) | 5   | SD(TXD) | Send data     | Output           |
|            | 6   | RD(RXD) | Receive data  | Input            |
|            | 7   | SG(0V)  | Signal ground | ---              |
|            | 8   | FG      | Frame ground  | ---              |

**Note: 1.** CP2W-CIFD1 can only be mounted on option slot 1.  
 PORT□ is supported by serial port 1 and PORT□ (EX) is supported by serial port 1(EX).

## CP2W-CIFD2 RS-232C&RS-485 Option Board

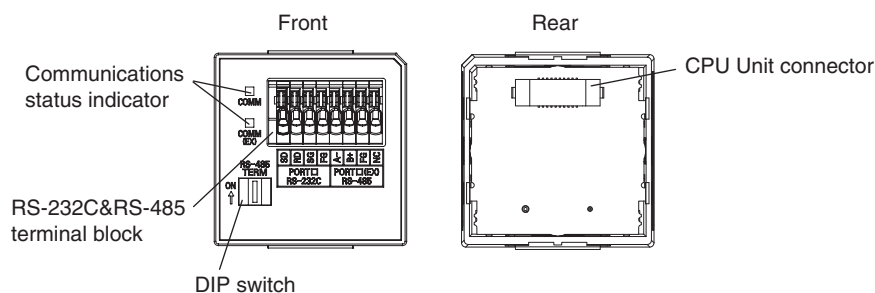

DIP switch

### RS-232C&RS-485 Terminal Block

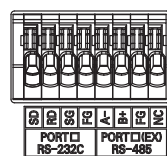

| Port       | Pin | Abbr.   | Signal Name         | Signal direction |
|------------|-----|---------|---------------------|------------------|
| PORT□      | 1   | SD(TXD) | Send data           | Output           |
|            | 2   | RD(RXD) | Receive data        | Input            |
|            | 3   | SG(0V)  | Signal ground       | ---              |
|            | 4   | FG      | Frame ground        | ---              |
| PORT□ (EX) | 5   | A-      | Send/Receive data - | Output           |
|            | 6   | B+      | Send/Receive data + | Input            |
|            | 7   | FG      | Frame ground        | ---              |
|            | 8   | NC      | NC                  | ---              |

**Note:** CP2W-CIFD2 can only be mounted on option slot 1.  
 PORT□ is supported by serial port 1 and PORT□ (EX) is supported by serial port 1(EX).

### DIP switch for terminating resistance settings

| Setting |     |                |  |
|---------|-----|----------------|--|
|         | ON  | ON (both ends) | Terminating resistance selection<br>Resistance value: 220Ω typical |
|         | OFF | OFF            |  |

## CP2W-CIFD3 RS-485&RS-485 Option Board

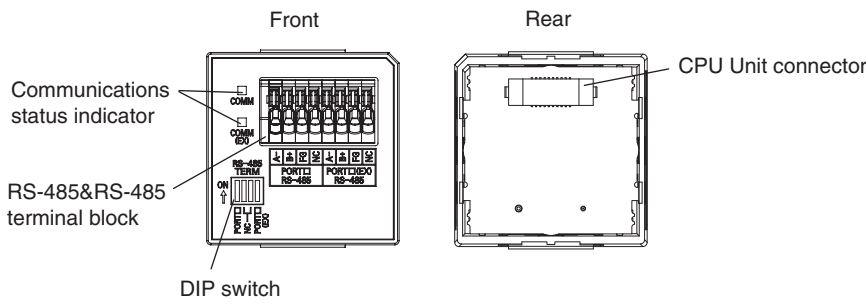

### RS-485&RS-485 Terminal Block

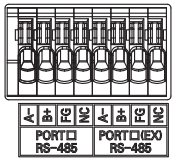

| Port       | Pin | Abbr. | Signal Name         | Signal direction |
|------------|-----|-------|---------------------|------------------|
| PORT□      | 1   | A-    | Send/Receive data - | Output           |
|            | 2   | B+    | Send/Receive data + | Input            |
|            | 3   | FG    | Frame ground        | ---              |
|            | 4   | NC    | NC                  | ---              |
| PORT□ (EX) | 5   | A-    | Send/Receive data - | Output           |
|            | 6   | B+    | Send/Receive data + | Input            |
|            | 7   | FG    | Frame ground        | ---              |
|            | 8   | NC    | NC                  | ---              |

**Note: 1.** CP2W-CIFD3 can only be mounted on option slot 1.  
 PORT□ is supported by serial port 1 and PORT□ (EX) is supported by serial port 1(EX).

### DIP switch for terminating resistance settings

| Pin | Setting |     |                |  |
|-----|---------|-----|----------------|--|
|     | 1       | ON  | ON (both ends) | Terminating resistance selection<br>Resistance value: 220Ω typical |
|     |         | OFF | OFF            |  |
|     | 2       | --- | ---            | Not used.  |
|     | 3       | --- | ---            | Not used.  |
|     | 4       | ON  | ON (both ends) | Terminating resistance selection<br>Resistance value: 220Ω typical |
|     |         | OFF | OFF            |  |

## Analog Option Board

### N□□-type CPU Units

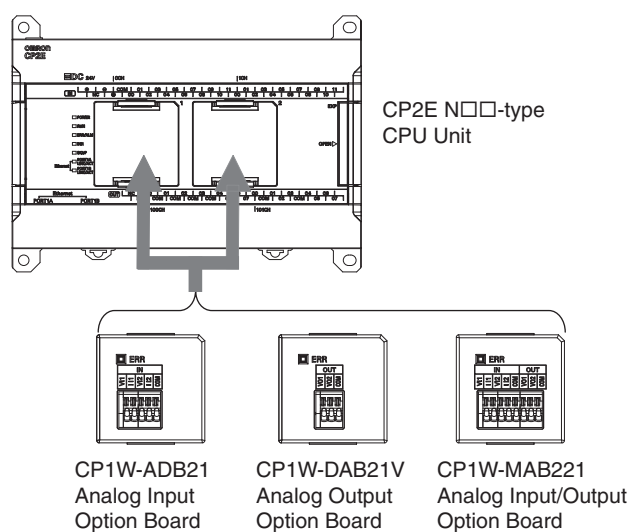

**Note: 1.** Maximum one Analog Option Board can be mounted on an N□□-type CPU Unit.  
If two Analog Option Boards are mounted, an option board error will occur and both Analog Option Boards do not work.

### Analog Option Board

Analog option board units are non-isolated analog units which allow you to easily realize analog input/output function for CP2E N□□-type CPU Unit.

| Analog Option Board        |             | Voltage Input<br>0V~10V<br>(Resolution: 1/4000) | Current Input<br>0mA~20mA<br>(Resolution: 1/2000) | Voltage Output<br>0V~10V<br>(Resolution: 1/4000) |
|----------------------------|-------------|---|---|--|
| Analog I/O Option Board    | CP1W-MAB221 | 2CH   |   | 2CH  |
| Analog Input Option Board  | CP1W-ADB21  | 2CH   |   | ---  |
| Analog Output Option Board | CP1W-DAB21V | ---   |   | 2CH  |

**Specifications of Analog Option Board  
CP1W-ADB21**

| Item                     | Specifications   |                     |
|--------------------------|--|---------------------|
|                          | Voltage Input  | Current Input       |
| Input signal range       | 0 to 10 V  | 0 to 20 mA          |
| Max. rated input         | 0 to 15 V  | 0 to 30 mA          |
| External input impedance | 200 kΩ min.  | Approx. 250 Ω       |
| Resolution               | 1/4000 (full scale)  | 1/2000 (full scale) |
| Overall accuracy         | 25°C   | ±0.5% (full scale)  |
|                          | 0 to 60°C  | ±1.0% (full scale)  |
|                          | -20 to 0°C   | ±1.3% (full scale)  |
| A/D conversion data      | 0000 to 0FA0 Hex   | 0000 to 07D0 Hex    |
| Averaging function       | None   |                     |
| Isolation method         | No isolation between analog I/O terminals and internal circuits. |                     |
| Current consumption      | 5 VDC: 20 mA max.  |                     |

**CP1W-DAB21V**

| Item                                      | Specifications   |                    |
|---|--|--------------------|
|   | Voltage Output   | Current Output     |
| Output signal range                       | 0 to 10 V  | ---                |
| External output allowable load resistance | 2 kΩ min.  | ---                |
| External output impedance                 | 0.5 Ω max.   | ---                |
| Resolution                                | 1/4000 (full scale)  | ---                |
| Overall accuracy                          | 25°C   | ±0.5% (full scale) |
|   | 0 to 60°C  | ±1.0% (full scale) |
|   | -20 to 0°C   | ±1.3% (full scale) |
| Set data (D/A conversion)                 | 0000 to 0FA0 Hex   | ---                |
| Isolation method                          | No isolation between analog I/O terminals and internal circuits. |                    |
| Current consumption                       | 5 VDC: 60 mA max.  |                    |

**CP1W-MAB221**

| Item                      | Specifications   |                     |                    |
|---------------------------|--|---------------------|--------------------|
|                           | Voltage I/O  | Current I/O         |                    |
| Analog Input Section      | Input signal range   | 0 to 10 V           |                    |
|                           | Max. rated input   | 0 to 15 V           |                    |
|                           | External input impedance   | 200 kΩ min.         |                    |
|                           | Resolution   | 1/4000 (full scale) |                    |
|                           | Overall accuracy   | 25°C                | ±0.5% (full scale) |
|                           |  | 0 to 60°C           | ±1.0% (full scale) |
|                           |  | -20 to 0°C          | ±1.3% (full scale) |
| A/D conversion data       | 0000 to 0FA0 Hex   |                     |                    |
| Averaging function        | None   |                     |                    |
| Analog Output Section     | Output signal range  | 0 to 10 VDC         |                    |
|                           | External output allowable load resistance                        | 2 kΩ min.           |                    |
|                           | External output impedance  | 0.5 Ω max.          |                    |
|                           | Resolution   | 1/4000 (full scale) |                    |
|                           | Overall accuracy   | 25°C                | ±0.5% (full scale) |
|                           |  | 0 to 60°C           | ±1.0% (full scale) |
|                           |  | -20 to 0°C          | ±1.3% (full scale) |
| Set data (D/A conversion) | 0000 to 0FA0 Hex   |                     |                    |
| Isolation method          | No isolation between analog I/O terminals and internal circuits. |                     |                    |
| Current consumption       | 5 VDC: 80 mA max.  |                     |                    |

**Analog Option Board Refresh Time (Typical values)**

| Analog Option Board | Cycle time (ms) |        |        |
|---------------------|-----------------|--------|--------|
|                     | 1 ms            | 10 ms  | 20 ms  |
| CP1W-ADB21          | 16~40           | 20~60  | 20~100 |
| CP1W-DAB21V         | 9~37            | 26~58  | 46~86  |
| CP1W-MAB221(AD)     | 14~62           | 18~109 | 20~160 |
| CP1W-MAB221(DA)     | 9~53            | 26~102 | 46~150 |



## Specifications of Expansion I/O Units and Expansion Units

### Expandable CPU Units

- Expansion I/O Units and Expansion Units cannot be connected to E14/20 or N14/20 CPU Units.
- A total of up to three Expansion I/O Units and Expansion Units can be connected to an E30/40/60, S30/40/60 or N30/40/60 CPU Unit.

#### CP2E-E14/20 or N14/20 CPU Unit

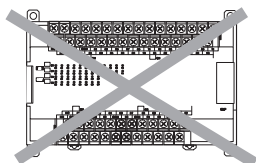
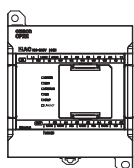

CP-series Expansion Units and Expansion I/O Units cannot be connected.

#### CP2E-E30/40/60, S30/40/60 or N30/40/60 CPU Unit

A total of up to three CP-series Expansion I/O Units and Expansion Units can be connected.

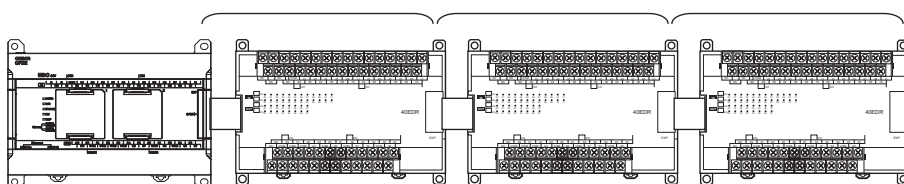

### Connection Methods

Connection cables for the Expansion I/O Units and Expansion Units are used to connect the Units. The length can be extended by using a CP1W-CN811 I/O Connecting Cable (length: 800 mm).

### Maximum Number of I/O Points for an Expansion I/O Unit or Expansion Unit

| CPU Unit     | Built-in I/O on CPU Unit |                  |                   | Total number of Expansion I/O Units and Expansion Units that can be connected | Number of inputs: 24<br>Number of outputs: 16<br>Total number of I/O points when three CP1W-40ED□ Expansion I/O Units are connected |                  |                   |
|--------------|--------------------------|------------------|-------------------|---|---|------------------|-------------------|
|              | Total                    | Number of inputs | Number of outputs |   | Total   | Number of inputs | Number of outputs |
| CP2E-□14D□-□ | 14                       | 8                | 6                 | Not possible.<br><br>3 Units maximum  | 14  | 8                | 6                 |
| CP2E-□20D□-□ | 20                       | 12               | 8                 |   | 20  | 12               | 8                 |
| CP2E-□30D□-□ | 30                       | 18               | 12                |   | 150   | 90               | 60                |
| CP2E-□40D□-□ | 40                       | 24               | 16                |   | 160   | 96               | 64                |
| CP2E-□60D□-□ | 60                       | 36               | 24                |   | 180   | 108              | 72                |

## Specifications of Expansion I/O Units

### Input Specifications (CP1W-8ED/20EDR1/20EDT/20EDT1/40EDR/40EDT/40EDT1)

| Item                  | Specification            |
|-----------------------|--------------------------|
| Input voltage         | 24 VDC, +10% / -15%      |
| Input impedance       | 4.7 kΩ                   |
| Input current         | 5 mA typical             |
| ON voltage / current  | 14.4 VDC min. / 3mA min. |
| OFF voltage / current | 5.0 VDC max. / 1mA max.  |
| ON response time      | 1 ms max. *1             |
| OFF response time     | 1 ms max. *1             |

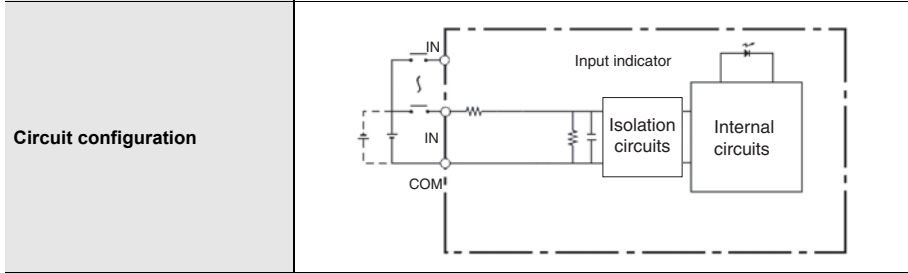

**Note: 1.** Do not apply voltage in excess of the rated voltage to the input terminal.

\*1. The response time is the delay caused by hardware. The delay set in the PLC Setup (0 to 32 ms, default: 8 ms) must be added to this value. For the CP1W-40EDR/EDT/EDT1, a fixed value of 16 ms must be added.

### Output Specifications

#### Relay Outputs (CP1W-8ER/16ER/20EDR1/32ER/40EDR)

| Item                    | Specification  |   |
|-------------------------|--|---|
| Max. switching capacity | 2 A, 250 VAC (cosφ = 1),<br>2 A, 24 VDC (4 A/common) |   |
| Min. switching capacity | 10 mA, 5 VDC   |   |
| Service life of relay   | Electrical   | Resistive load<br>150,000 operations (24 VDC)<br>Inductive load<br>100,000 operations (240 VAC, cosφ = 0.4) |
|                         | Mechanical   | 20,000,000 operations   |
|                         | ON response time                                     | 15 ms max.  |
| OFF response time       | 15 ms max.   |   |

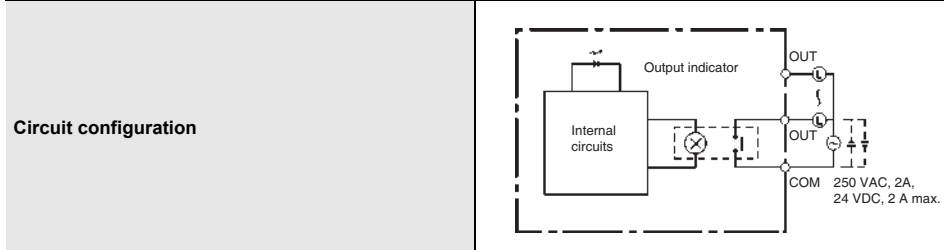

**Note: 1.** Estimating the Service Life of Relays

The service life of output contacts is as shown in the following diagram.

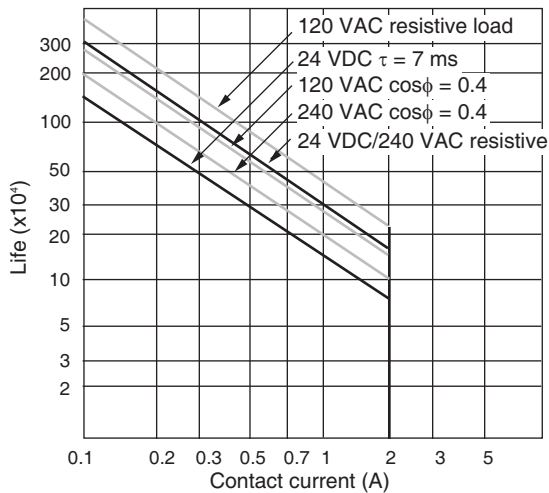

Switching frequency: 1,800 operations/hour

2. Restrictions of CP1W-16ER/32ER  
Limit the output load current to satisfy the following derating curve.

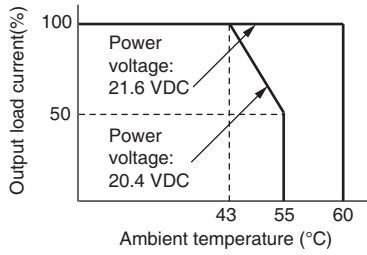

3. CP1W-32ER's maximum number of simultaneously ON output points is 24 (75%).  
Relation between Number of ON Outputs and Ambient Temperature (CP1W-32ER)

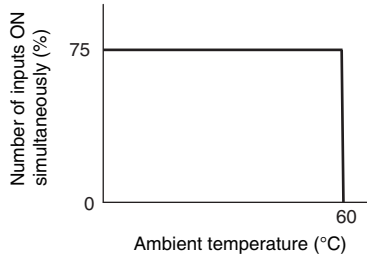

4. According to the ambient temperature, there are restrictions on power supply voltage and output load current for the CPU Units connected with the Expansion I/O Units (CP1W-8ER/16ER/20EDR1/32ER/40EDR). Use the PLC in the range of the power supply voltage and output load current as show below.
- The ambient temperature is restricted for the DC power supply CPU Units.  
Derating curve of the output load current for Expansion I/O Units (CP1W-8ER/16ER/20EDR1/32ER/40EDR).

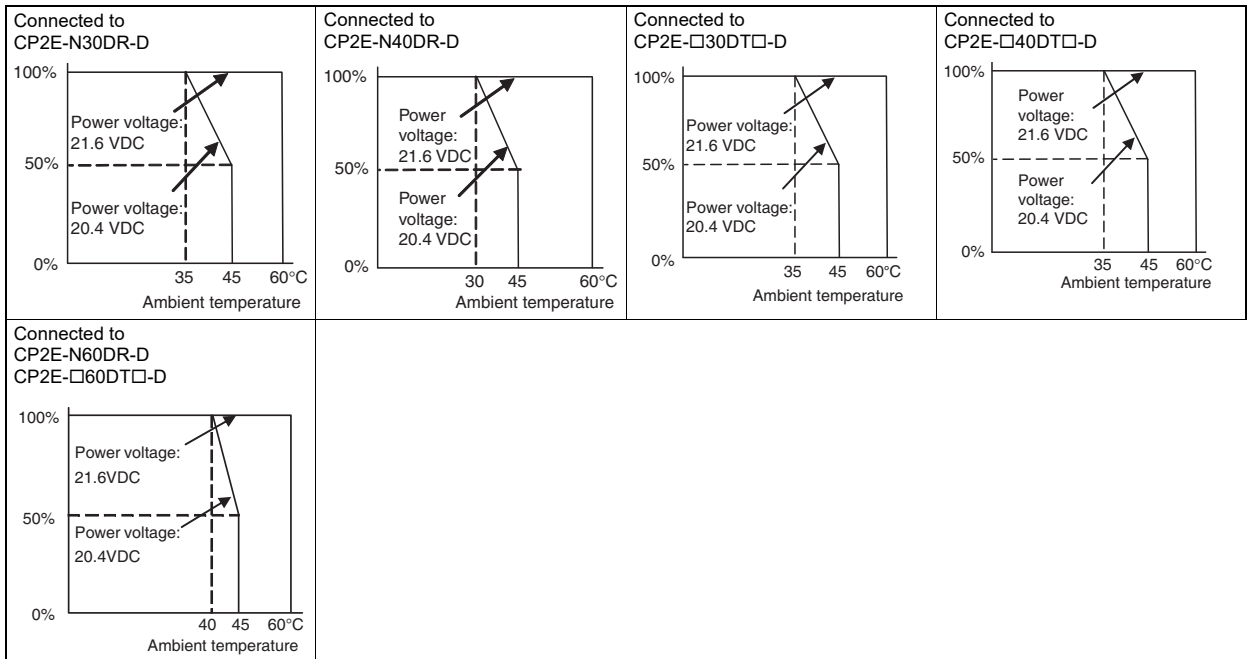

## Transistor Outputs (Sinking or Sourcing)

| Item   | Specification   |   |   |   |   |
|--|---|---|---|---|---|
|  | CP1W-40EDT<br>CP1W-40EDT1                                   | CP1W-32ET<br>CP1W-32ET1                                     | CP1W-20EDT<br>CP1W-20EDT1                                     | CP1W-16ET<br>CP1W-16ET1                                     | CP1W-8ET<br>CP1W-8ET1                                       |
| <b>Max. switching capacity *1</b>                  | 4.5 to 30 VDC<br>0.3 A/output<br>0.9 A/common<br>3.6 A/Unit | 4.5 to 30 VDC<br>0.3 A/output<br>0.9 A/common<br>7.2 A/Unit | 24 VDC +10%/-5%<br>0.3 A/output<br>0.9 A/common<br>1.8 A/Unit | 4.5 to 30 VDC<br>0.3 A/output<br>0.9 A/common<br>3.6 A/Unit | 4.5 to 30 VDC<br>0.3 A/output<br>0.9 A/common<br>1.8 A/Unit |
| <b>Leakage current</b>                             | 0.1 mA max.   | 0.1 mA max.   | 0.1 mA max.   | 0.1 mA max.   | 0.1 mA max.   |
| <b>Residual voltage</b>                            | 1.5 V max.  | 1.5 V max.  | 1.5 V max.  | 1.5 V max.  | 1.5 V max.  |
| <b>ON response time</b>                            | 0.1 ms max.   | 0.1 ms max.   | 0.1 ms.   | 0.1 ms max.   | 0.1 ms max.   |
| <b>OFF response time</b>                           | 1 ms max.<br>At 24 VDC +10%/-5%, 5 to 300 mA                | 1 ms max.<br>At 24 VDC +10%/-5%, 5 to 300 mA                | 1 ms max.<br>At 24 VDC +10%/-5%, 5 to 300 mA                  | 1 ms max.<br>At 24 VDC +10%/-5%, 5 to 300 mA                | 1 ms max.<br>At 24 VDC +10%/-5%, 5 to 300 mA                |
| <b>Maximum number of simultaneously ON outputs</b> | 16 points<br>(100% load)                                    | 24 points<br>(100% load)                                    | 8 points<br>(100% load)                                       | 16 points<br>(100% load)                                    | 8 points<br>(100% load)                                     |
| <b>Fuse *2</b>                                     | 1 fuse/common   |   |   |   |   |

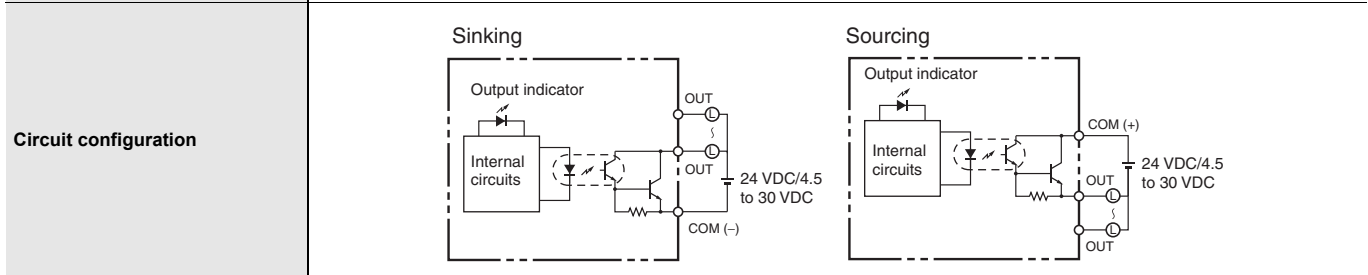

\*1. If the ambient temperature is maintained below 50°C, up to 0.9 A/common can be used.

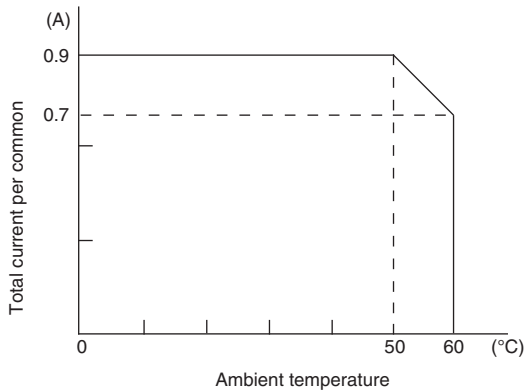

\*2. The fuse cannot be replaced by the user. Replace the Unit if the fuse breaks due to an short-circuit or overcurrent.  
**Note: 1.** Do not connect a load to an output terminal or apply a voltage in excess of the maximum switching capacity.

## Specifications of Expansion Units

### Analog Input Units

| Model                           |            | CP1W-AD041   |                          | CP1W-AD042   |                          |
|---------------------------------|------------|--|--------------------------|--|--------------------------|
| Item                            |            | Voltage input  | Current input            | Voltage input  | Current input            |
| Number of analog inputs         |            | 4 inputs (4 words allocated)   |                          |  |                          |
| Input signal range              |            | 0 to 5 V, 1 to 5 V,<br>0 to 10 V, or -10 to 10 V   | 0 to 20 mA or 4 to 20 mA | 0 to 5 V, 1 to 5 V,<br>0 to 10 V, or -10 to 10 V   | 0 to 20 mA or 4 to 20 mA |
| Max. rated input                |            | ±15 V  | ±30 mA                   | ±15 V  | ±30 mA                   |
| External input impedance        |            | 1 MΩ min.  | Approx. 250 Ω            | 1 MΩ min.  | Approx. 250 Ω            |
| Resolution                      |            | 1/6000 (full scale)  |                          | 1/12000 (full scale)   |                          |
| Overall accuracy                | 25°C       | 0.3% full scale  | 0.4% full scale          | 0.2% full scale  | 0.3% full scale          |
|                                 | 0 to 55°C  | 0.6% full scale  | 0.8% full scale          | 0.5% full scale  | 0.7% full scale          |
|                                 | 55 to 60°C | 0.7% full scale  | 0.8% full scale          | 0.5% full scale  | 0.7% full scale          |
|                                 | -20 to 0°C | 0.8% full scale  | 1% full scale            | 0.7% full scale  | 0.9% full scale          |
| A/D conversion data             |            | 16-bit binary (4-digit hexadecimal)<br>Full scale for -10 to 10 V: F448 to 0BB8 hex<br>Full scale for other ranges: 0000 to 1770 hex |                          | 16-bit binary (4-digit hexadecimal)<br>Full scale for -10 to 10 V: E890 to 1770 hex<br>Full scale for other ranges: 0000 to 2EE0 hex |                          |
| Averaging function              |            | Supported (Set in output words n+1 and n+2.)   |                          |  |                          |
| Open-circuit detection function |            | Supported  |                          |  |                          |
| Conversion time                 |            | 2 ms/point (8 ms/all points)   |                          | 1 ms/point (4 ms/all points)   |                          |
| Isolation method                |            | Photocoupler isolation between analog input terminals and internal circuits. No isolation between analog I/O signals.                |                          |  |                          |
| Current consumption             |            | 5 VDC: 100 mA max.; 24 VDC: 90 mA max.   |                          | 5 VDC: 100 mA max.; 24 VDC: 50 mA max.   |                          |

### Analog Output Units

| Model                                     |            | CP1W-DA021/CP1W-DA041  |                          | CP1W-DA042   |                          |
|---|------------|--|--------------------------|--|--------------------------|
| Item                                      |            | Voltage output   | Current output           | Voltage output   | Current output           |
| Number of analog outputs                  |            | CP1W-DA021: 2 outputs (2 words allocated)<br>CP1W-DA041: 4 outputs (4 words allocated)   |                          | 4 outputs (4 words allocated)  |                          |
| Output signal range                       |            | 1 to 5 V, 0 to 10 V, or<br>-10 to 10 V   | 0 to 20 mA or 4 to 20 mA | 1 to 5 V, 0 to 10 V, or<br>-10 to 10 V   | 0 to 20 mA or 4 to 20 mA |
| External output allowable load resistance |            | 2 kΩ min.  | 350 Ω max.               | 2 kΩ min.  | 350 Ω max.               |
| External output impedance                 |            | 0.5 Ω max.   | ---                      | 0.5 Ω max.   | ---                      |
| Resolution                                |            | 1/6000 (full scale)  |                          | 1/12000 (full scale)   |                          |
| Overall accuracy                          | 25°C       | 0.4% full scale  |                          | 0.3% full scale  |                          |
|   | 0 to 55°C  | 0.8% full scale  |                          | 0.7% full scale  |                          |
|   | -20 to 0°C | 1% full scale  |                          | 0.9% full scale  |                          |
| D/A conversion data                       |            | 16-bit binary (4-digit hexadecimal)<br>Full scale for -10 to 10 V: F448 to 0BB8 hex<br>Full scale for other ranges: 0000 to 1770 hex |                          | 16-bit binary (4-digit hexadecimal)<br>Full scale for -10 to 10 V: E890 to 1770 hex<br>Full scale for other ranges: 0000 to 2EE0 hex |                          |
| Conversion time                           |            | CP1W-DA021: 2 ms/point (4 ms/all points)<br>CP1W-DA041: 2 ms/point (8 ms/all points)   |                          | 1 ms/point (4 ms/all points)   |                          |
| Isolation method                          |            | Photocoupler isolation between analog output terminals and internal circuits. No isolation between analog I/O signals.               |                          |  |                          |
| Current consumption                       |            | CP1W-DA021: 5 VDC: 40 mA max.; 24 VDC: 95 mA max.<br>CP1W-DA041: 5 VDC: 80 mA max.; 24 VDC: 124 mA max.                              |                          | 5 VDC: 70 mA max.; 24 VDC: 160 mA max.   |                          |

Analog I/O Units

| Model                           |  | CP1W-MAD42/CP1W-MAD44  |  | CP1W-MAD11                                    |                          |                 |
|---------------------------------|--|--|--|---|--------------------------|-----------------|
| Item                            |  | Voltage I/O  | Current I/O  | Voltage I/O                                   | Current I/O              |                 |
| Analog Input Section            | Number of inputs   | 4 inputs (4 words allocated)   |  | 2 inputs (2 words allocated)                  |                          |                 |
|                                 | Input signal range   | 0 to 5 V, 1 to 5 V, 0 to 10 V, or -10 to 10 V  | 0 to 20 mA or 4 to 20 mA   | 0 to 5 V, 1 to 5 V, 0 to 10 V, or -10 to 10 V | 0 to 20 mA or 4 to 20 mA |                 |
|                                 | Max. rated input   | ±15 V  | ±30 mA   | ±15 V   | ±30 mA                   |                 |
|                                 | External input impedance   | 1 MΩ min.  | Approx. 250 Ω  | 1 MΩ min.                                     | Approx. 250 Ω            |                 |
|                                 | Resolution   | 1/12000 (full scale)   |  | 1/6000 (full scale)                           |                          |                 |
|                                 | Overall accuracy   | 25°C   | 0.2% full scale  | 0.3% full scale                               | 0.3% full scale          | 0.4% full scale |
|                                 |  | 0 to 55°C  | 0.5% full scale  | 0.7% full scale                               | 0.6% full scale          | 0.8% full scale |
|                                 |  | -20 to 0°C   | 0.7% full scale  | 0.9% full scale                               | 0.8% full scale          | 1% full scale   |
| A/D conversion data             | 16-bit binary (4-digit hexadecimal)<br>Full scale for -10 to 10 V: E890 to 1770 hex<br>Full scale for other ranges: 0000 to 2EE0 hex |  | 16-bit binary (4-digit hexadecimal)<br>Full scale for -10 to 10 V: F448 to 0BB8 hex<br>Full scale for other ranges: 0000 to 1770 hex |   |                          |                 |
| Averaging function              | Supported  |  | Supported (Settable for individual inputs via DIP switch)  |   |                          |                 |
| Open-circuit detection function | Supported  |  |  |   |                          |                 |
| Analog Output Section           | Number of outputs  | CP1W-MAD42: 2 outputs (2 words allocated)<br>CP1W-MAD44: 4 outputs (4 words allocated) |  | 1 output (1 word allocated)                   |                          |                 |
|                                 | Output signal range  | 1 to 5 V, 0 to 10 V, or -10 to 10 V  | 0 to 20 mA or 4 to 20 mA   | 1 to 5 V, 0 to 10 V, or -10 to 10 V           | 0 to 20 mA or 4 to 20 mA |                 |
|                                 | Allowable external output load resistance  | 2 kΩ min.  | 350 Ω max.   | 1 kΩ min.                                     | 600 Ω max.               |                 |
|                                 | External output impedance  | 0.5 Ω max.   | ---  | 0.5 Ω max.                                    | ---                      |                 |
|                                 | Resolution   | 1/12000 (full scale)   |  | 1/6000 (full scale)                           |                          |                 |
|                                 | Overall accuracy   | 25°C   | 0.3% full scale  | 0.4% full scale                               | 0.4% full scale          | 0.8% full scale |
|                                 |  | 0 to 55°C  | 0.7% full scale  | 0.8% full scale                               | 0.8% full scale          | 1% full scale   |
| -20 to 0°C                      |  | 0.9% full scale  | 1% full scale  | 1% full scale                                 | 1% full scale            |                 |
| Set data (D/A conversion)       | 16-bit binary (4-digit hexadecimal)<br>Full scale for -10 to 10 V: E890 to 1770 hex<br>Full scale for other ranges: 0000 to 2EE0 hex |  | 16-bit binary (4-digit hexadecimal)<br>Full scale for -10 to 10 V: F448 to 0BB8 hex<br>Full scale for other ranges: 0000 to 1770 hex |   |                          |                 |
| Conversion time                 | CP1W-MAD42: 1 ms/point (6 ms/all points)<br>CP1W-MAD44: 1 ms/point (8 ms/all points)   |  | 2 ms/point (6 ms/all points)   |   |                          |                 |
| Isolation method                | Photocoupler isolation between analog I/O terminals and internal circuits.<br>No isolation between analog I/O signals.               |  |  |   |                          |                 |
| Current consumption             | CP1W-MAD42:<br>5 VDC: 120 mA max., 24 VDC: 120 mA max.<br>CP1W-MAD44:<br>5 VDC: 120 mA max., 24 VDC: 170 mA max.                     |  | 5 VDC: 83 mA max., 24 VDC: 110 mA max.   |   |                          |                 |

Temperature Sensors Units

| Item                       |            | CP1W-TS001   | CP1W-TS002 | CP1W-TS101  | CP1W-TS102 |
|----------------------------|------------|--|------------|---|------------|
| Temperature sensors        |            | Thermocouples  |            | Platinum resistance thermometer   |            |
|                            |            | Switchable between K and J, but same type must be used for all inputs. |            | Switchable between Pt100 and JPt100, but same type must be used for all inputs. |            |
| Number of inputs           |            | 2  | 4          | 2   | 4          |
| Allocated input words      |            | 2  | 4          | 2   | 4          |
| Accuracy                   | 25°C       | (The larger of ±0.5% of converted value or ±2°C) ±1 digit max.         |            | (The larger of ±0.5% of converted value or ±1°C) ±1 digit max.                  |            |
|                            | 0 to 60°C  | (The larger of ±1% of converted value or ±4°C) ±1 digit max.           |            | (The larger of ±1% of converted value or ±2°C) ±1 digit max.                    |            |
|                            | -20 to 0°C | (The larger of ±1.3% of converted value or ±5°C) ±1 digit max. *1      |            | (The larger of ±1.3% of converted value or ±3°C) ±1 digit max.                  |            |
| Conversion time            |            | 250 ms for 2 or 4 input points   |            |   |            |
| Converted temperature data |            | 16-bit binary data (4-digit hexadecimal)                               |            |   |            |
| Isolation                  |            | Photocouplers between all temperature input signals                    |            |   |            |
| Current consumption        |            | 5 VDC: 40 mA max., 24 VDC: 59 mA max.                                  |            | 5 VDC: 54 mA max., 24 VDC: 73 mA max.   |            |

\*1. Accuracy for a K-type sensor at -100°C or less is ±4°C ±1 digit max.

The rotary switch is used to set the temperature range.

| Setting  | CP1W-TS001/TS002 |                |               | CP1W-TS101/TS102 |            |                 |                   |
|--|------------------|----------------|---------------|------------------|------------|-----------------|-------------------|
|  | Input type       | Range (°C)     | Range (°F)    | Input type       | Range (°C) | Range (°F)      |                   |
|  | 0                | K              | -200 to 1,300 | -300 to 2,300    | Pt100      | -200.0 to 650.0 | -300.0 to 1,200.0 |
|  | 1                |                | 0.0 to 500.0  | 0.0 to 900.0     | JPt100     | -200.0 to 650.0 | -300.0 to 1,200.0 |
|  | 2                | J              | -100 to 850   | -100 to 1,500    | ---        | Cannot be set.  |                   |
|  | 3                | 0.0 to 400.0   | 0.0 to 750.0  | ---              |            |                 |                   |
| 4 to F   | ---              | Cannot be set. |               | ---              |            |                 |                   |

## Main Specifications

| Item                            |             | CP1W-TS003   |  |
|---------------------------------|-------------|--|--|
| Temperature sensors             |             | Thermocouples or analog input *1<br>Switchable between K and J, but same type must be used for all inputs. |  |
| Number of inputs                |             | 4  |  |
| Allocated input words           |             | 4  |  |
| Max. number of Units            |             | 3  |  |
| Accuracy                        | 25°C        | Thermocouple inputs  | (The larger of $\pm 0.5\%$ of converted value or $\pm 2^\circ\text{C}$ ) $\pm 1$ digit max. *2 |
|                                 |             | Analog voltage inputs  | 0.5% full scale  |
|                                 |             | Analog current inputs  | 0.6% full scale  |
|                                 | 0 to 60 °C  | Thermocouple inputs  | (The larger of $\pm 1\%$ of converted value or $\pm 4^\circ\text{C}$ ) $\pm 1$ digit max. *3   |
|                                 |             | Analog voltage inputs  | 1.0% full scale  |
|                                 |             | Analog current inputs  | 1.2% full scale  |
|                                 | -20 to 0 °C | Thermocouple inputs  | (The larger of $\pm 1.3\%$ of converted value or $\pm 5^\circ\text{C}$ ) $\pm 1$ digit max. *3 |
|                                 |             | Analog voltage inputs  | 1.2% full scale  |
|                                 |             | Analog current inputs  | 1.5% full scale  |
| Input signal range              |             | Thermocouple inputs  | K: -200.0 to 1300.0°C or -300.0 to 2300.0°F<br>J: -100.0 to 850.0°C or -100.0 to 1500.0°F      |
|                                 |             | Analog voltage inputs  | 0 to 10V/1 to 5V   |
|                                 |             | Analog current inputs  | 4 to 20mA  |
| Resolution                      |             | Thermocouple inputs  | 0.1°C or 0.1°F   |
|                                 |             | Analog inputs  | 1/12000 (full scale)   |
| Max. rated input                |             | Analog voltage inputs  | $\pm 15\text{V}$   |
|                                 |             | Analog current inputs  | $\pm 30\text{mA}$  |
| External input impedance        |             | Analog voltage inputs  | 1M $\Omega$ min.   |
|                                 |             | Analog current inputs  | 250 $\Omega$   |
| Open-circuit detection function |             | Supported  |  |
| Averaging function              |             | Unsupported  |  |
| Conversion time                 |             | 250 ms for 4 input points  |  |
| Converted temperature data      |             | 16-bit binary data (4-digit hexadecimal)<br>2-decimal-place mode is not supported                          |  |
| Converted AD data               |             | 16-bit binary data (4-digit hexadecimal)   |  |
| Isolation                       |             | Photocouplers between any two input signals  |  |
| Current consumption             |             | 5 VDC: 70 mA max., 24 VDC: 30 mA max.  |  |

\*1. Only last two channels can be used as analog input.

\*2. Accuracy for a K-type sensor at  $-100^\circ\text{C}$  or less is  $\pm 4^\circ\text{C} \pm 1$  digit max.

\*3. Accuracy for a K-type sensor at  $-100^\circ\text{C}$  or less is  $\pm 10^\circ\text{C} \pm 1$  digit max.

### DIP Switch Settings

With the Temperature Sensor Unit's DIP switch, set the input type (temperature or analog input), the input thermocouple type (K or J) and the temperature unit ( $^\circ\text{C}$  or  $^\circ\text{F}$ ).

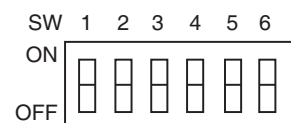

| SW | Setting   |                      |
|----|---|----------------------|
| 1  | Thermocouple type of temperature sensor             | ON J                 |
|    |   | OFF K                |
| 2  | Temperature unit                                    | ON $^\circ\text{F}$  |
|    |   | OFF $^\circ\text{C}$ |
| 3  | NC  |                      |
| 4  | Input type selection for the third input (Input 2)  | ON Analog input      |
|    |   | OFF Thermocouple     |
| 5  | Input type selection for the fourth input (Input 3) | ON Analog input      |
|    |   | OFF Thermocouple     |
| 6  | Analog input signal range                           | ON 1 to 5V/4 to 20mA |
|    |   | OFF 0 to 10V         |

| Temperature input |                            |                            | Analog input |                  |
|-------------------|----------------------------|----------------------------|--------------|------------------|
| Input type        | Range ( $^\circ\text{C}$ ) | Range ( $^\circ\text{F}$ ) | Input type   | Range            |
| K                 | -200.0 to 1300.0           | -300.0 to 2300.0           | Voltage      | 0 to 10V/1 to 5V |
| J                 | -100.0 to 850.0            | -100.0 to 1500.0           | Current      | 4 to 20mA        |

## Main Specifications

| Item                       |            | CP1W-TS004  |
|----------------------------|------------|---|
| Temperature sensors        |            | Thermocouples<br>Switchable between K and J, but same type must be used for all inputs. |
| Number of inputs           |            | 12  |
| Allocated input words      |            | 2   |
| Allocated output words     |            | 1   |
| Accuracy                   | 25°C       | (The larger of ±0.5% of converted value or ±2°C) ±1 digit max. *1                       |
|                            | 0 to 60°C  | (The larger of ±1% of converted value or ±4°C) ±1 digit max. *2                         |
|                            | -20 to 0°C | (The larger of ±1.3% of converted value or ±5°C) ±1 digit max. *2                       |
| Conversion time            |            | 500 ms for 12 input points  |
| Converted temperature data |            | 16-bit binary data (4-digit hexadecimal)<br>2-decimal-place mode is not supported       |
| Isolation                  |            | Photocouplers between any two input signals   |
| Current consumption        |            | 5 VDC: 80 mA max., 24 VDC: 50 mA max.   |

\* 1 Accuracy for a K-type sensor at -100°C or less is ±4°C ±1 digit max.

\* 2 Accuracy for a K-type sensor at -100°C or less is ±10°C ±1 digit max.

## DIP Switch Settings

With the Temperature Sensor Unit's DIP switch, set the temperature unit and the temperature input range.

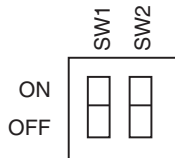

| SW | Setting          | ON | OFF |
|----|------------------|----|-----|
| 1  | Input type       | J  | K   |
|    |                  | K  | J   |
| 2  | Temperature unit | °F | °C  |
|    |                  | °C | °F  |

| Temperature input |                  |                  |
|-------------------|------------------|------------------|
| Input type        | Range (°C)       | Range (°F)       |
| K                 | -200.0 to 1300.0 | -300.0 to 2300.0 |
| J                 | -100.0 to 850.0  | -100.0 to 1500.0 |



## Dimensions

### CPU Units with 14 or 20 I/O Points

#### CP2E-N14/20D□-□

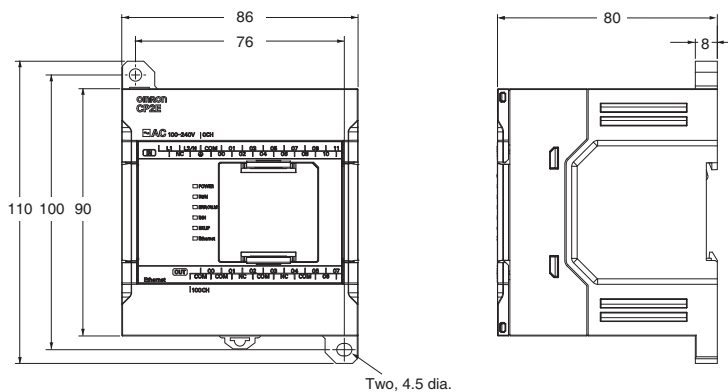

#### CP2E-E14/20D□-□

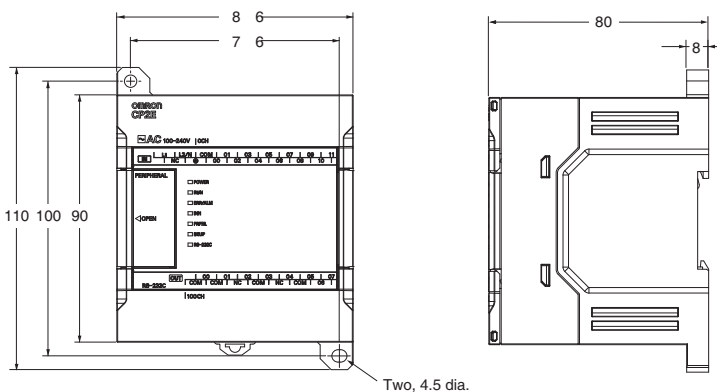

### CPU Units with 30 I/O Points

#### CP2E-N30D□-□

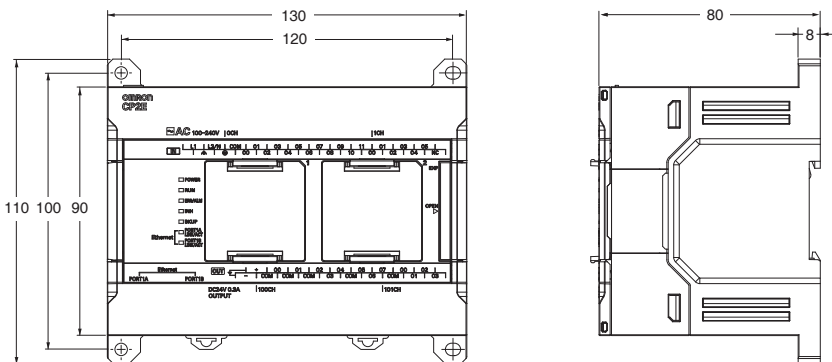

#### CP2E-E30D□-□, CP2E-S30D□-□

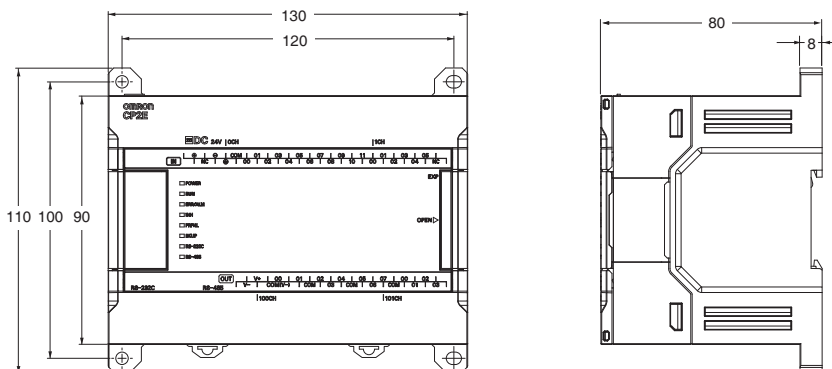

# CP2E

## CPU Units with 40 I/O Points

### CP2E-N40D□-□

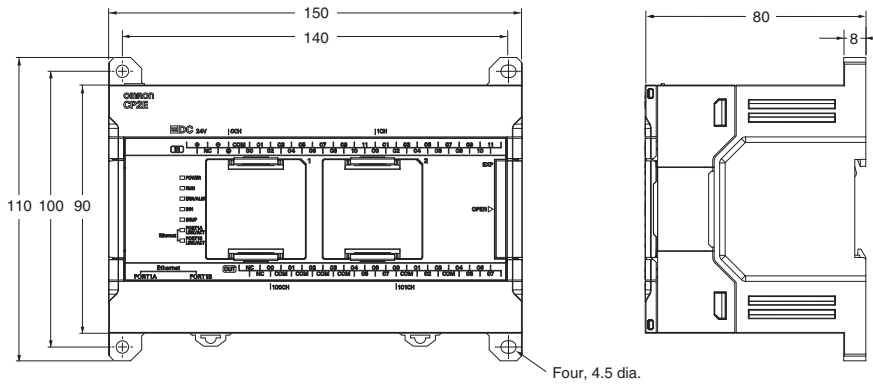

### CP2E-E40D□-□, CP2E-S40D□-□

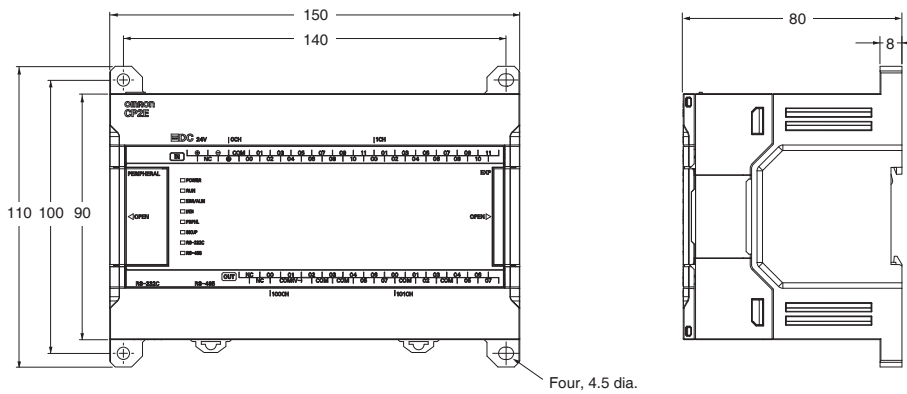

## CPU Units with 60 I/O Points

### CP2E-N60D□-□

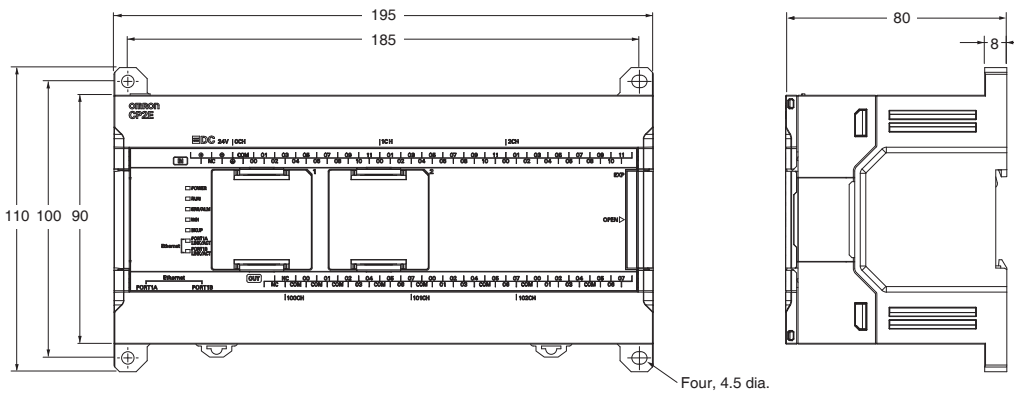

### CP2E-E60D□-□, CP2E-S60D□-□

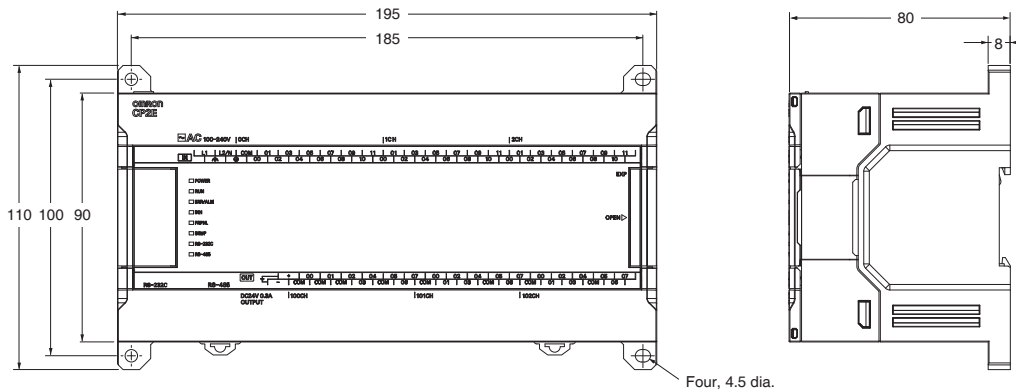

Expansion I/O Units and Expansion Units

CP1W-8E□□

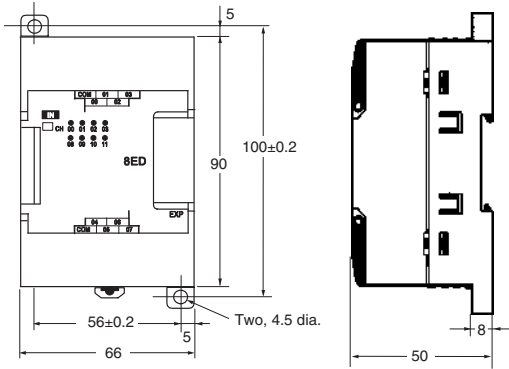

CP1W-20ED□/CP1W-16E□□/CP1W-AD04□/CP1W-DA021/CP1W-DA04□/CP1W-MAD□□/  
CP1W-TS□□1/□□2/□□3

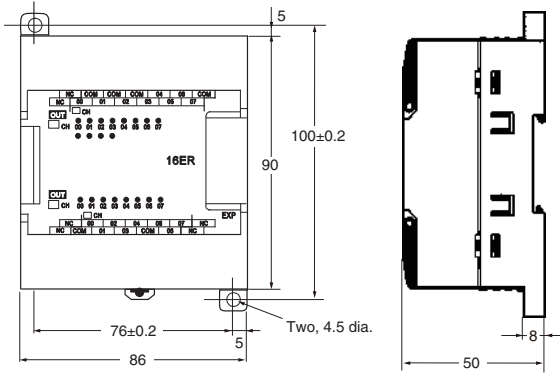

CP1W-40ED□/CP1W-32E□□/CP1W-TS004

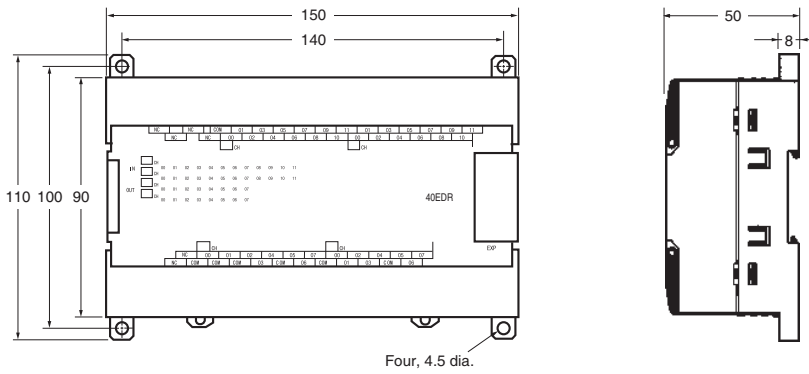

Comparison of specifications of CP2E and CP1E

| Specifications                           | CP2E   |   |  | CP1E   |   |  |   |
|--|--|---|--|--|---|--|---|
|  | CP2E-N□□   | CP2E-S□□  | CP2E-E□□   | CP1E-N□□   | CP1E-N□□S□  | CP1E-E□□<br>CP1E-E□□S  | CP1E-NA20   |
| Number of built-in I/O points            | 14/20/30/40/60   | 30/40/60  | 14/20/30/40/60   | 14/20/30/40/60   | 30/40/60  | 10/14/20/30/40/60  | 20  |
| Total number of Expansion units          | 14/20 points None<br>30/40/60 points 3 units   |   |  | 14/20 points None<br>30/40/60 points 3 units   |   |  |   |
| Lineup Output/power supply type          | <ul style="list-style-type: none"> <li>Relay/AC</li> <li>Relay/DC</li> <li>Transistor (sinking)/AC</li> <li>Transistor (sinking)/DC</li> <li>Transistor (sourcing)/DC</li> </ul> | <ul style="list-style-type: none"> <li>Relay/AC</li> <li>Transistor (sinking)/DC</li> <li>Transistor (sourcing)/DC</li> </ul> | <ul style="list-style-type: none"> <li>Relay/AC</li> </ul> | <ul style="list-style-type: none"> <li>Relay/AC</li> <li>Relay/DC</li> <li>Transistor (sinking)/AC</li> <li>Transistor (sourcing)/AC</li> <li>Transistor (sinking)/DC</li> <li>Transistor (sourcing)/DC</li> </ul> | <ul style="list-style-type: none"> <li>Relay/AC</li> <li>Transistor (sinking)/DC</li> <li>Transistor (sourcing)/DC</li> </ul> | <ul style="list-style-type: none"> <li>Relay/AC</li> <li>Relay/DC</li> <li>Transistor (sinking)/AC</li> <li>Transistor (sourcing)/AC</li> <li>Transistor (sinking)/DC</li> <li>Transistor (sourcing)/DC</li> </ul> | <ul style="list-style-type: none"> <li>Relay/AC</li> <li>Transistor (sinking)/DC</li> <li>Transistor (sourcing)/DC</li> </ul> |
| Program capacity                         | 10K steps  | 8K steps  | 4K steps   | 8K steps   | 8K steps  | 2K steps   | 8K steps  |
| FB capacity                              | 10K steps  | 8K steps  | 4K steps   | None   |   |  |   |
| Function block steps                     | Yes<br>Languages usable in function block definitions:<br>Ladder diagrams, structured text (ST)  |   |  | None   |   |  |   |
| Overhead processing time                 | 0.2 ms   | 0.15 ms   | 0.1 ms   | 0.4 ms   |   |  |   |
| Instruction execution times              | LD 0.23 μs<br>MOV 1.76 μs  |   |  | LD 1.19 μs<br>MOV 7.9 μs   |   |  |   |
| Data memory capacity                     | 16K words  | 8K words  | 4K words   | 8K words   | 8K words  | 2K words   | 8K words  |
| IO Memory backup                         | Built-in non-volatile memory (Batteryless backup)  |   |  | Built-in SRAM (Battery backup)   |   |  |   |
| Pulse outputs                            | N14/20:<br>2 outputs 100 kHz<br>N30/40/60:<br>4 outputs 100 kHz<br>(Linear interpolation possible)   | 2 outputs<br>100 kHz  | None   | 2 outputs<br>100kHz  | 2 outputs<br>100kHz   | None   | 2 outputs<br>100kHz   |
| High-speed counters (Differential Phase) | N14/20:<br>2 counters (50 kHz, 5 kHz)<br>N30/40/60:<br>2 counters (50 kHz x2)  | 2 counters (50 kHz, 5 kHz)  |  | 2 counters (50 kHz, 5 kHz)   |   | 2 counters (5 kHz x2)  | 2 counters (50 kHz, 5 kHz)  |
| Quick-response Interrupt inputs          | 8 inputs<br>(6 inputs only for 14 points)  | 6 inputs  |  | 6 inputs<br>(4 inputs only for 10 points)  |   |  |   |
| Ethernet port                            | Included<br>N14/20: 1 port<br>N30/40/60: 2 port  | None  | None   | None<br>N30/40/60 only:<br>1 port<br>(CP1W-CIF41 use)  | None  | None   | 1 port<br>(CP1W-CIF41 use)  |
| USB port                                 | None   | Included  | Included   | Included   |   |  |   |
| Serial port                              | N14/20:<br>Max 2 port<br>(Option boards use)<br>N30/40/60:<br>Max 3 port<br>(Option boards use)  | 2 port<br>RS-232C<br>RS-485   | 1 port<br>RS-232C  | N14/20:<br>1 port<br>RS-232C<br>N30/40/60:<br>Max 2 port<br>RS-232C<br>Option board  | 1 port<br>RS-232C<br>N30/40/60<br>S1 Type only:<br>Max 2 port<br>RS-232C<br>RS-485  | None   | Max 2 port<br>RS-232C<br>Option board   |
| Serial communication protocols           | Host Link<br>1: N NT Link (1: N)<br>No-protocol mode<br>Serial PLC Link (master, slave)<br>Modbus-RTU easy master<br>Modbus-RTU Slave  |   |  | Host Link<br>1: N NT Link (1: N)<br>No-protocol mode<br>Serial PLC Link (master, slave)<br>Modbus-RTU easy master  |   |  |   |
| Option Boards                            | N14/20: 1 unit<br>N30/40/60: 2 units   | None  | None   | N14/20: None<br>N30/40/60: 1 unit  | None  | None   | 1 unit  |
| Clock function                           | Yes  | Yes   | None   | Yes  | Yes   | None   | Yes   |
| Corresponding battery                    | CP2W-BAT02<br>(for clock function)   |   | None   | CP1W-BAT01<br>(for clock function, IO memory backup)   |   | None   | CP1W-BAT01  |
| Built-in analog                          | None   |   |  | None   |   |  | Analog input<br>2channels<br>Analog output<br>1channel  |
| Analog adjusters                         | None   | None  | None   | Yes  | None  | E□□: Yes<br>E□□S: None   | Yes   |
| Ambient operating temperature            | -20 to 60 °C   |   |  | 0 to 55 °C   |   |  |   |

## Easy to convert CP1E code into CP2E code

Uploaded CP1E code can be converted into CP2E code with just one click.



Cx-One Ver 4.51 or higher  
Cp-programmer Ver 9.72 or higher

### Examples of replacement of CP1E with CP2E

| CP1E-E□□/E□□S         | CP2E-E□□               |
|-----------------------|------------------------|
| CP1E-E10D□-□          | CP2E-E14DR-A or others |
| CP1E-E14SDR-A/E14DR-A | CP2E-E14DR-A           |
| CP1E-E20SDR-A/E20DR-A | CP2E-E20DR-A           |
| CP1E-E30SDR-A/E30DR-A | CP2E-E30DR-A           |
| CP1E-E40SDR-A/E40DR-A | CP2E-E40DR-A           |
| CP1E-E60SDR-A         | CP2E-E60DR-A           |

| CP1E-N□□S               | CP2E-S□□     |
|-------------------------|--------------|
| CP1E-N30SD□-□/N30S1D□-□ | CP2E-S30D□-□ |
| CP1E-N40SD□-□/N40S1D□-□ | CP2E-S40D□-□ |
| CP1E-N60SD□-□/N60S1D□-□ | CP2E-S60D□-□ |

| CP1E-N□□     | CP2E-S□□ *1  | CP2E-N□□ *1                          |
|--------------|--------------|--------------------------------------|
| CP1E-N14D□-□ | -            | CP2E-N14D□-□                         |
| CP1E-N20D□-□ | -            | CP2E-N20D□-□                         |
| CP1E-N30D□-□ | CP2E-S30D□-□ | CP2E-N30D□-□                         |
| CP1E-N40D□-□ | CP2E-S40D□-□ | CP2E-N40D□-□                         |
| CP1E-N60D□-□ | CP2E-S60D□-□ | CP2E-N60D□-□                         |
| CP1E-NA20□-□ | -            | CP2E-N30D□-□ + CP1W-MAB221 or others |

\*1. When the AC powered N30/40/60 CPU Unit with relay outputs, or the DC powered N30/40/60 CPU Unit with transistor outputs is used without an option board or with the CP1W-CIF11 Option Board, it is recommended to replace with the CP2E-S□□.

When any of the other CPU units is used with an option board, it is recommended to replace with the CP2E-N□□.  
For details, refer to the *Replacement Guide from CP1E to CP2E* (Cat. No. P150).

# CP2E

## Related Manuals

| Manual name  | Cat. No. | Model numbers   | Application   | Contents   |
|--|----------|---|---|--|
| SYSMAC CP Series<br>CP2E CPU Unit<br>Hardware User's<br>Manual             | W613     | CP2E-E□□D□-□<br>CP2E-S□□D□-□<br>CP2E-N□□D□-□  | To learn the hardware specifications of the CP2E PLCs   | Describes the following information for CP2E PLCs. <ul style="list-style-type: none"> <li>• Overview and features</li> <li>• Basic system configuration</li> <li>• Part names and functions</li> <li>• Installation and settings</li> <li>• Troubleshooting</li> </ul>   |
| SYSMAC CP Series<br>CP2E CPU Unit<br>Software User's<br>Manual             | W614     | CP2E-E□□D□-□<br>CP2E-S□□D□-□<br>CP2E-N□□D□-□  | To learn the software specifications of the CP2E PLCs   | Describes the following information for CP2E PLCs. <ul style="list-style-type: none"> <li>• CPU Unit operation</li> <li>• Internal memory</li> <li>• Programming</li> <li>• Settings</li> <li>• CPU Unit built-in functions <ul style="list-style-type: none"> <li>• Interrupts</li> <li>• High-speed counter inputs</li> <li>• Pulse outputs</li> <li>• Serial communications</li> <li>• Ethernet</li> <li>• Other functions</li> </ul> </li> </ul> |
| SYSMAC CP Series<br>CP1E/CP2E CPU Unit<br>Instructions<br>Reference Manual | W483     | CP1E-E□□D□-□<br>CP1E-N□□D□-□<br>CP1E-NA□□D□-□<br>CP2E-E□□D□-□<br>CP2E-S□□D□-□<br>CP2E-N□□D□-□   | To learn programming instructions in detail   | Describes each programming instruction in detail.  |
| CS/CJ/CP/NSJ Series<br>Communications<br>Commands<br>Reference Manual      | W342     | CS1G/H-CPU□□H<br>CS1G/H-CPU□□-V1<br>CS1D-CPU□□H<br>CS1D-CPU□□S<br>CS1W-SCU□□-V1<br>CS1W-SCB□□-V1<br>CJ1G/H-CPU□□H<br>CJ1G-CPU□□P<br>CJ1M-CPU□□<br>CJ1G-CPU□□<br>CJ1W-SCU□□-V1 | To learn communications commands for CS/CJ/CP/NSJ-series Controllers in detail                        | Describes <ol style="list-style-type: none"> <li>1) C-mode commands and</li> <li>2) FINS commands in detail.</li> </ol> Read this manual for details on C-mode and FINS commands addressed to CPU Units.   |
| CX-One FA Integrated<br>Tool Package Setup<br>Manual                       | W463     | CXONE-AL□□D-V4  | To install the software provided in the CX-One  | Describes the overview of the CX-One FA Integrated Tool Package, and how to install and uninstall the CX-One.  |
| CX-Programmer<br>Operation Manual  | W446     |   | To learn the operation procedures for the CX-Programmer, the Programming Device for Windows computers | Describes the operation procedures for the CX-Programmer.  |
| CX-Programmer<br>Operation Manual<br>(Function Blocks/<br>Structured Text) | W447     |   |   |  |
| CX-Simulator<br>Operation Manual   | W366     |   | To learn the operation procedures for the CX-Simulator, the Simulation Device for Windows computers   | Describes the operation procedures for the CX-Simulator.   |
| CX-Integrator<br>Operation Manual  | W464     |   | To set up and monitor networks  | Describes the operation procedures for the CX-Integrator.  |

Microsoft, Windows are either registered trademarks or trademarks of Microsoft Corporation in the United States and other countries. Other company names and product names in this document are the trademarks or registered trademarks of their respective companies. The product photographs and figures that are used in this catalog may vary somewhat from the actual products.

# Terms and Conditions Agreement

## **Read and understand this catalog.**

Please read and understand this catalog before purchasing the products. Please consult your OMRON representative if you have any questions or comments.

## **Warranties.**

- (a) Exclusive Warranty. Omron's exclusive warranty is that the Products will be free from defects in materials and workmanship for a period of twelve months from the date of sale by Omron (or such other period expressed in writing by Omron). Omron disclaims all other warranties, express or implied.
- (b) Limitations. OMRON MAKES NO WARRANTY OR REPRESENTATION, EXPRESS OR IMPLIED, ABOUT NON-INFRINGEMENT, MERCHANTABILITY OR FITNESS FOR A PARTICULAR PURPOSE OF THE PRODUCTS. BUYER ACKNOWLEDGES THAT IT ALONE HAS DETERMINED THAT THE PRODUCTS WILL SUITABLY MEET THE REQUIREMENTS OF THEIR INTENDED USE.

Omron further disclaims all warranties and responsibility of any type for claims or expenses based on infringement by the Products or otherwise of any intellectual property right. (c) Buyer Remedy. Omron's sole obligation hereunder shall be, at Omron's election, to (i) replace (in the form originally shipped with Buyer responsible for labor charges for removal or replacement thereof) the non-complying Product, (ii) repair the non-complying Product, or (iii) repay or credit Buyer an amount equal to the purchase price of the non-complying Product; provided that in no event shall Omron be responsible for warranty, repair, indemnity or any other claims or expenses regarding the Products unless Omron's analysis confirms that the Products were properly handled, stored, installed and maintained and not subject to contamination, abuse, misuse or inappropriate modification. Return of any Products by Buyer must be approved in writing by Omron before shipment. Omron Companies shall not be liable for the suitability or unsuitability or the results from the use of Products in combination with any electrical or electronic components, circuits, system assemblies or any other materials or substances or environments. Any advice, recommendations or information given orally or in writing, are not to be construed as an amendment or addition to the above warranty.

See <http://www.omron.com/global/> or contact your Omron representative for published information.

## **Limitation on Liability; Etc.**

OMRON COMPANIES SHALL NOT BE LIABLE FOR SPECIAL, INDIRECT, INCIDENTAL, OR CONSEQUENTIAL DAMAGES, LOSS OF PROFITS OR PRODUCTION OR COMMERCIAL LOSS IN ANY WAY CONNECTED WITH THE PRODUCTS, WHETHER SUCH CLAIM IS BASED IN CONTRACT, WARRANTY, NEGLIGENCE OR STRICT LIABILITY.

Further, in no event shall liability of Omron Companies exceed the individual price of the Product on which liability is asserted.

## **Suitability of Use.**

Omron Companies shall not be responsible for conformity with any standards, codes or regulations which apply to the combination of the Product in the Buyer's application or use of the Product. At Buyer's request, Omron will provide applicable third party certification documents identifying ratings and limitations of use which apply to the Product. This information by itself is not sufficient for a complete determination of the suitability of the Product in combination with the end product, machine, system, or other application or use. Buyer shall be solely responsible for determining appropriateness of the particular Product with respect to Buyer's application, product or system. Buyer shall take application responsibility in all cases.

NEVER USE THE PRODUCT FOR AN APPLICATION INVOLVING SERIOUS RISK TO LIFE OR PROPERTY OR IN LARGE QUANTITIES WITHOUT ENSURING THAT THE SYSTEM AS A WHOLE HAS BEEN DESIGNED TO ADDRESS THE RISKS, AND THAT THE OMRON PRODUCT(S) IS PROPERLY RATED AND INSTALLED FOR THE INTENDED USE WITHIN THE OVERALL EQUIPMENT OR SYSTEM.

## **Programmable Products.**

Omron Companies shall not be responsible for the user's programming of a programmable Product, or any consequence thereof.

## **Performance Data.**

Data presented in Omron Company websites, catalogs and other materials is provided as a guide for the user in determining suitability and does not constitute a warranty. It may represent the result of Omron's test conditions, and the user must correlate it to actual application requirements. Actual performance is subject to the Omron's Warranty and Limitations of Liability.

## **Change in Specifications.**

Product specifications and accessories may be changed at any time based on improvements and other reasons. It is our practice to change part numbers when published ratings or features are changed, or when significant construction changes are made. However, some specifications of the Product may be changed without any notice. When in doubt, special part numbers may be assigned to fix or establish key specifications for your application. Please consult with your Omron's representative at any time to confirm actual specifications of purchased Product.

## **Errors and Omissions.**

Information presented by Omron Companies has been checked and is believed to be accurate; however, no responsibility is assumed for clerical, typographical or proofreading errors or omissions.

**Note: Do not use this document to operate the Unit.**

**OMRON Corporation Industrial Automation Company**

**Kyoto, JAPAN**

**Contact : [www.ia.omron.com](http://www.ia.omron.com)**

**Regional Headquarters**

**OMRON EUROPE B.V.**

Wegalaan 67-69, 2132 JD Hoofddorp  
The Netherlands  
Tel: (31) 2356-81-300 Fax: (31) 2356-81-388

**OMRON ELECTRONICS LLC**

2895 Greenspoint Parkway, Suite 200  
Hoffman Estates, IL 60169 U.S.A.  
Tel: (1) 847-843-7900 Fax: (1) 847-843-7787

**OMRON ASIA PACIFIC PTE. LTD.**

438B Alexandra Road, #08-01/02 Alexandra  
Technopark, Singapore 119968  
Tel: (65) 6835-3011 Fax: (65) 6835-2711

**OMRON (CHINA) CO., LTD.**

Room 2211, Bank of China Tower,  
200 Yin Cheng Zhong Road,  
PuDong New Area, Shanghai, 200120, China  
Tel: (86) 21-5037-2222 Fax: (86) 21-5037-2200

**Authorized Distributor:**

©OMRON Corporation 2019-2022 All Rights Reserved.  
In the interest of product improvement,  
specifications are subject to change without notice.

**CSM\_2\_4**

**Cat. No. P145-E1-03** 0922 (0919)