



AV20LHX30U-GB215

- left-hand model
- Thermoplastic enclosure
- Fail-safe locking system
- for 1-leaf doors
- authorised for use in passenger elevators
- Manual release by means of M5 triangular key

Data

Ordering data

Product type description	AV20LHX30U-GB215
Article number (order number)	103016447
EAN (European Article Number)	4030661508511
eCl@ss number, version 12.0	27-27-26-03
eCl@ss number, version 11.0	27-27-26-03
eCl@ss number, version 9.0	27-27-26-03
ETIM number, version 7.0	EC002593
ETIM number, version 6.0	EC002593

Approvals - Standards

Certificates	TÜV CCC
--------------	------------

General data

Standards	EN 81-20 EN 81-50
Housing material	Plastic, glass-fibre reinforced thermoplastic, self-extinguishing
Material of the latching bolt	Brass
Gross weight	751 g

General data - Features

Manual release	Yes
With fail-safe locking system (Y/N)	Yes
Safety functions	Yes
Number of auxiliary contacts	1
Number of door leafs	1
Number of safety contacts	1

Mechanical data

Actuating element	Roller lever H65
Orientation / Alignment	left-hand model
Mounting	rear-side mounting holes
Permanent magnet	Ceramic oxide magnets with high coercive field strength

Mechanical data - Connection technique

Cable entry	without cable gland
-------------	---------------------

Mechanical data - Dimensions

Width	165 mm
Height	80 mm

Depth	37 mm
Diameter of the latching bolt	18 mm
X-dimension of the latching bolt	30 mm
Note (X-dimension of the latching bolt)	The entire locking bolt length results from the prescribed insertion depth of the locking bolt into the door leaf of 21 mm and dimension X. Dimension X represents the distance between the bottom of the enclosure of the door closing device and the top of the door.
Latching bolt bevelling, bottom	45 °

Ambient conditions

Degree of protection	IP54
Ambient temperature	-15 ... +70 °C

Ambient conditions - Insulation values

Rated insulation voltage U_i	500 VAC
Rated impulse withstand voltage U_{imp}	6 kV

Electrical data

Thermal test current	10 A
Utilisation category AC-15	230 VAC
Utilisation category AC-15	2 A
Utilisation category DC-13	200 VDC
Utilisation category DC-13	2 A
Switching element	NC contact, NO contact
Switching principle	Slow action

Material of the contacts, electrical Silver

Note

Note (Manual release) For manual release using M5 triangular key, available as accessory

Ordering code

Product type description:
AV 20(1)(2)(3)U-GB215

(1)

L	left-hand model
R	right-hand model

(2)

without	Pull strap
H	Lever H65
H92	Lever H92
H105	Lever H105
B	Bearing block B
B2	Bearing block B2

(3)

X11,5	X-dimension of the latching bolt = 11,5 mm
X20	X-dimension of the latching bolt = 20 mm
X30	X-dimension of the latching bolt = 30 mm
X40	X-dimension of the latching bolt = 40 mm
X45	X-dimension of the latching bolt = 45 mm

Note:

U = interlock bevel on the underside
GB215 = additional, front-side M8 mounting holes

Variants that differ from this are special versions.
Availability on request.

Pictures

Product picture (catalogue individual photo)



ID: kav20f04

| 448.5 kB | .jpg | 352.778 x 305.153 mm - 1000 x 865 px - 72 dpi

| 34.5 kB | .png | 74.083 x 64.206 mm - 210 x 182 px - 72 dpi

| 55.0 kB | .jpg | 123.472 x 106.892 mm - 350 x 303 px - 72 dpi

Images (miscellaneous)

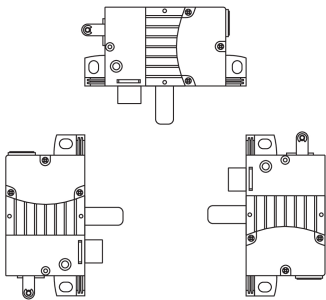

ID: kav20m02

| 123.2 kB | .jpg | 352.778 x 323.85 mm - 1000 x 918 px - 72 dpi

Assembly example



ID: kav--m03

| 23.5 kB | .cdr |

Schmersal India Pvt. Ltd., Plot No - G-7/1, Ranjangaon MIDC, Tal. - Shirur, Dist.- Pune 412 220

The details and data referred to have been carefully checked. Images may diverge from original. Further technical data can be found in the manual. Technical amendments and errors possible.

Generated on: 16/09/2024, 6:41 am