



ZQ315AR-11

- Metal enclosure
- wire pull and breakage detection
- Design to EN 50041
- Quick connection technology as connection terminals rotated by 45°
- cable entry 1 x M20 x 1,5

Data

Ordering data

Product type description	ZQ315AR-11
Article number (order number)	103044924
EAN (European Article Number)	4030661616841
eCl@ss number, version 12.0	27-37-12-01
eCl@ss number, version 11.0	27-37-12-01
eCl@ss number, version 9.0	27-37-12-01
ETIM number, version 7.0	EC002033
ETIM number, version 6.0	EC002033

Approvals - Standards

Certificates	cULus CCC
--------------	--------------

General data

Standards	EN ISO 13850 EN IEC 60947-5-1 EN IEC 60947-5-5
Housing construction form	Norm construction design

Actuator type to EN 50041	B
Housing material	Metal, zinc die-cast
Housing coating material	painted
Length of the wire, maximum	25 m
Gross weight	467 g

Safety classification

Standards	EN ISO 13849-1
Mission time	20 Year(s)

Safety classification - Safety outputs

B _{10D} Normally-closed contact (NC)	100,000 Operations
---	--------------------

Mechanical data

Mechanical life, minimum	10,000,000 Operations
Actuation direction	right
Positive break force, minimum	50 N
Tightening torque of the fixing screws	2 Nm
Tightening torque of the fastening screws for the housing cover	2.6 Nm

Mechanical data - Connection technique

Termination	Screw terminals M20 x 1.5
Cable section, minimum	0.34 mm ²
Cable section, maximum	1.5 mm ²
Tightening torque of electrical connection, minimum	0.6 Nm
Tightening torque of electrical connection, maximum	0.8 Nm

Mechanical data - Dimensions

Length	32.4 mm
Width	40 mm
Height	93.4 mm
Width of the actuator	91 mm
Height of the actuator	21.4 mm

Ambient conditions

Degree of protection	IP66 IP67
Ambient temperature	-30 ... +80 °C
Protection class	I

Ambient conditions - Insulation values

Rated insulation voltage U_i	300 VAC
Rated impulse withstand voltage U_{imp}	4 kV
Degree of pollution	3

Electrical data

Thermal test current	10 A
Required rated short-circuit current	400 A
Utilisation category AC-15	240 VAC
Utilisation category AC-15	3 A
Utilisation category DC-13	24 VDC
Utilisation category DC-13	3 A
Switching element	1 NO contact, 1 NC contacts
Material of the contacts, electrical	Silver

Note

Note (General)

Recommended cable lengths for pull-wire Emergency-Stop switches in relation to the range of ambient temperature.

As the thimbles are subject to deformation in case of wire pull, the wire should be pulled several times after fitting. After that, the wire must be re-tensioned using the eyebolt or the tensioner.

At 2 m ... 5 m distance intermediate wire supports are required, see accessories

Ordering code

Product type description:

ZQ(1)(2)-(3)(4)-(5)-(6)

(1)

215 Metal enclosure, design to EN 50047

215L like 215 with elongated hole

315 Metal enclosure, design to EN 50041

(2)

without Pulling direction of the towing eye upwards

AL Pulling direction of the towing eye to the left

AR Pulling direction of the towing eye to the right

(3)

11 1 NO contacts/1 NC contact

02 2 NC contact

12 1 NO contact/2 NC contacts

(4)

without Contacts silver plated (Standard)

A1 Gold contacts 0,3 µm

A2 Gold contacts 1,0 µm

A3 Gold contacts 3,0 µm

(5)

without

without LED

G

Status LED

(6)

without

Cable entry M20

ST

Connector plug M12, 4-pole or 8-pole

STM

Connector plug M12, metal, 4-pole or 8-pole

Pictures

Product picture (catalogue individual photo)



ID: kzq315f01

| 540.7 kB | .jpg | 352.778 x 533.047 mm - 1000 x 1511 px - 72 dpi

| 58.9 kB | .png | 74.083 x 111.831 mm - 210 x 317 px - 72 dpi

| 43.0 kB | .jpg | 81.844 x 123.472 mm - 232 x 350 px - 72 dpi

Dimensional drawing basic component

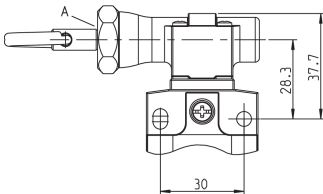

ID: kq315g02

| 83.0 kB | .jpg | 352.778 x 215.9 mm - 1000 x 612 px - 72 dpi

Dimensional drawing basic component

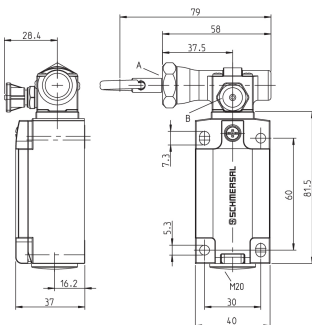

ID: kq315g03

| 163.6 kB | .jpg | 352.778 x 365.125 mm - 1000 x 1035 px - 72 dpi

Schmersal India Pvt. Ltd., Plot No - G-7/1, Ranjangaon MIDC, Tal. - Shirur, Dist.- Pune 412 220

The details and data referred to have been carefully checked. Images may diverge from original. Further technical data can be found in the manual. Technical amendments and errors possible.

Generated on: 30/08/2024, 11:27 am