



## SLB440-ER-3-LST

- Compact design With integral evaluation
- Height range 75 m (Reserve up to 90 m)
- Safe OSSD outputs to PLe
- Automatic start or restart interlock
- Sturdy metal enclosure with M12 connector or cable
- Version with heater for outdoor applications down to -30°C
- Set-up tool and diagnostic indication

## Data

### Ordering data

Product type description	SLB440-ER-3-LST
Article number (order number)	103013527
EAN (European Article Number)	4030661492391
eCl@ss number, version 12.0	27-27-27-01
eCl@ss number, version 11.0	27-27-27-01
eCl@ss number, version 9.0	27-27-27-01
ETIM number, version 7.0	EC001831
ETIM number, version 6.0	EC001831

### Approvals - Standards

Certificates	cULus
--------------	-------

### General data

Standards	EN IEC 61496-2 EN IEC 61496-1
-----------	----------------------------------

Coding, light barrier beam	3
Housing material	Aluminium
Reaction time, maximum	22 ms
Reaction time, minimum	7 ms
Gross weight	180 g

### General data - Features

Restart interlock (manual reset)	Yes
Beam coding available	Yes
Integral system diagnostics, status	Yes
Integral system diagnostics	Yes
Number of fail-safe digital outputs	2
Number of beams	1

### Safety classification

Standards	EN ISO 13849-1 EN IEC 62061
Performance Level, up to	e
Category	4
PFH value	$1.50 \times 10^{-8}$ /h
Safety Integrity Level (SIL), suitable for applications in	3
Mission time	20 Year(s)
Safety type in accordance with IEC 61496-1	4

### Mechanical data

Detection ability for test bodies at $v = 1.6$ m/s	40 mm
Range, protection field, minimum	0.3 m
Range, protection field, maximum	15 m
Wave length of the laserdiode	880 nm

## Mechanical data - Connection technique

Terminal connector, Recipient	Cable with connector plug M12, 5-pole
Terminal, Connector, Transmitter	Cable with connector plug M12, 4-pole

## Mechanical data - Dimensions

Length	33 mm
Width	27.8 mm
Height	72 mm

## Ambient conditions

Degree of protection	IP67
Ambient temperature	-30 ... +50 °C
Storage and transport temperature	-30 ... +70 °C
Protection class	III

## Electrical data

Switching voltage OSSD, HIGH signal	24 V
Electrical power consumption of the receiver, maximum	5 W
Electrical power consumption of the transmitter, maximum	5 W
Length of cable, maximum	100 m

## Electrical data - Safety digital outputs

Output current, (fail-safe output), maximum	0.2 A
Design of control elements	p-type

## Accessory

Recommended safety switchgear	PROTECT PSC1 SRB-E-204ST
-------------------------------	-----------------------------

## Ordering code

Product type description:

SLB440-ER-(1)-(2)-(3)-(4)

(1)

<b>1</b>	Beam coding 1
<b>2</b>	Beam coding 2
<b>3</b>	Beam coding 3
<b>4</b>	Beam coding 4

(2)

<b>ST</b>	Termination male connector
<b>LST</b>	Cable with connector

(3)

<b>H</b>	Alternative range
----------	-------------------

(4)

<b>EH</b>	Electric heater
-----------	-----------------

## Pictures

### Product picture (catalogue individual photo)



ID: kslb2f06

| 274.6 kB | .jpg | 352.778 x 278.342 mm - 1000 x 789 px - 72 dpi

| 19.1 kB | .png | 74.083 x 58.561 mm - 210 x 166 px - 72 dpi

| 33.7 kB | .jpg | 123.472 x 97.367 mm - 350 x 276 px - 72 dpi

### Dimensional drawing basic component

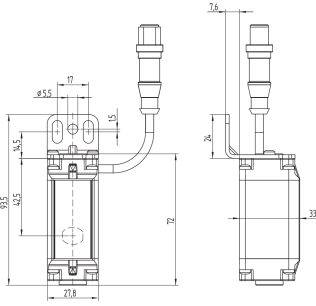

ID: kslb4g04

| 93.0 kB | .ai | 210.002 x 297 mm - 595 x 841 px - 72 dpi

| 4.4 kB | .png | 74.083 x 69.497 mm - 210 x 197 px - 72 dpi

| 129.3 kB | .jpg | 352.778 x 331.611 mm - 1000 x 940 px - 72 dpi

Schmersal India Pvt. Ltd., Plot No - G-7/1, Ranjangaon MIDC, Tal. - Shirur, Dist.- Pune 412 220

The details and data referred to have been carefully checked. Images may diverge from original. Further technical data can be found in the manual. Technical amendments and errors possible.

Generated on: 31/08/2024, 3:42 pm