



# OD2000-7002T15

OD2000

DISPLACEMENT MEASUREMENT SENSORS

**SICK**  
Sensor Intelligence.



### Ordering information

Type	Part no.
OD2000-7002T15	6074385

Other models and accessories → [www.sick.com/OD2000](http://www.sick.com/OD2000)



### Detailed technical data

#### Mechanics/electronics

<b>Supply voltage <math>V_s</math></b>	DC 18 V ... 24 V, $\pm 10\%$ , including residual ripple <sup>1)</sup>
<b>Power consumption</b>	1.5 W, At 24 V DC <sup>2)</sup>
<b>Warm-up time</b>	< 30 min
<b>Housing material</b>	Plastic (PBT)
<b>Window material</b>	Plastic (PMMA)
<b>Connection type</b>	Cable with male connector, M12, 5-pin, A-coded, 30 cm
<b>Indication</b>	OLED display, status LEDs
<b>Control elements</b>	4 buttons
<b>Weight</b>	90 g
<b>Dimensions (W x H x D)</b>	27 mm x 60 mm x 50 mm
<b>Enclosure rating</b>	IP67
<b>Protection class</b>	III (EN 50178)
<b>Electrical safety</b>	IEC 61010-1 AMD 1:2016-12

<sup>1)</sup> Limit values, reverse-polarity protected.

<sup>2)</sup> Without load, at +20 °C.

#### Safety-related parameters

<b>MTTF<sub>D</sub></b>	107 years
<b>DC<sub>avg</sub></b>	0%

## Performance

<b>Measurement range min ... max:</b>	200 mm ... 1,200 mm <sup>1)</sup>
<b>Target</b>	Natural objects
<b>Repeatability</b>	100 µm <sup>2) 3) 4)</sup>
<b>Linearity</b>	± 1 mm, 200 mm ... 700 mm <sup>2) 4) 5)</sup> ± 3 mm, 700 mm ... 1,200 mm <sup>2) 4) 5)</sup>
<b>Response time</b>	≥ 0.533 ms <sup>6)</sup>
<b>Measuring frequency</b>	≤ 7.5 kHz
<b>Output time</b>	≥ 0.1333 ms
<b>Light source</b>	Laser, red visible red light
<b>Laser class</b>	2 (IEC 60825-1:2014, EN 60825-1:2014) <sup>7)</sup>
<b>Typ. light spot size (distance)</b>	Ø 1 mm (700 mm)
<b>Additional function</b>	Adjustable average value or media filter, Switching mode: Distance to Object (DtO) / switching window / object between sensor and background (ObSB), teach-in of digital output, invertable digital output, teach-in of analog output, Invertable analog output, Switchable analog output (mA / V), Multifunctional input: sender off/hold functions/deactivated, switch-off display, lock user interface, Display can be rotated by 180°, Alarm function, Edge height jump, Time functions (ON/OFF delay, 1 shot), region of interest

<sup>1)</sup> 6 % ... 90 % remission; at default settings.

<sup>2)</sup> Measurement on 60 % remission (ceramic, white).

<sup>3)</sup> Average value setting: 512, median: 31, measuring frequency: 7.5 kHz, at T = 25 °C, in the middle of the measuring range, at constant basic conditions.

<sup>4)</sup> At T = +25 °C, under constant general conditions.

<sup>5)</sup> Observe min. warm-up time of 30 minutes.

<sup>6)</sup> Dependent on the set average or sensitivity.

<sup>7)</sup> Visible, wavelength: 655 nm, max. average power: 1 mW, max. pulse power: 1 mW, max. pulse duration: 5 ms.

## Interfaces

<b>IO-Link</b>	✓, IO-Link V1.1
Function	Process data, parameterization, diagnosis, data storage
Data transmission rate	230,4 kbit/s (COM3), Process data length 6 bytes, min. cycle time 0.7 ms
<b>Digital input</b>	In <sub>1</sub> Can be used as sender off, trigger for hold functions, or deactivated
<b>Digital output</b>	Number 2 <sup>1)</sup> Type PNP/NPN, selectable
<b>Analog output</b>	Number 1 Type Current output / voltage output Function Selectable Current 4 mA ... 20 mA, ≤ 300 Ω Voltage 0 V ... 10 V, > 10,000 Ω Resolution 16 bit

<sup>1)</sup> PNP/PP: HIGH = UV > 13.5 V/LOW = UV < 8 V; NPN: HIGH = UV < 8 V/LOW = UV > 13.5 V.

## Ambient data

<b>Ambient temperature, operation</b>	-10 °C ... +50 °C, Operating temperature at $V_S = 24\text{ V}$
<b>Ambient temperature, storage</b>	-20 °C ... +60 °C
<b>Relative air humidity (non-condensing)</b>	35 % ... 85 %
<b>Temperature drift</b>	600 $\mu\text{m/K}$
<b>Typ. Ambient light immunity</b>	Artificial light: $\leq 3,000\text{ lx}$ <sup>1)</sup> Sunlight: $\leq 10,000\text{ lx}$
<b>Vibration resistance</b>	EN 60068-2-6, EN 60068-2-64
<b>Shock resistance</b>	EN 60068-2-27

<sup>1)</sup> With constant object movement in the measuring range.

## Classifications

<b>eCl@ss 5.0</b>	27270801
<b>eCl@ss 5.1.4</b>	27270801
<b>eCl@ss 6.0</b>	27270801
<b>eCl@ss 6.2</b>	27270801
<b>eCl@ss 7.0</b>	27270801
<b>eCl@ss 8.0</b>	27270801
<b>eCl@ss 8.1</b>	27270801
<b>eCl@ss 9.0</b>	27270801
<b>eCl@ss 10.0</b>	27270801
<b>eCl@ss 11.0</b>	27270801
<b>eCl@ss 12.0</b>	27270916
<b>ETIM 5.0</b>	EC001825
<b>ETIM 6.0</b>	EC001825
<b>ETIM 7.0</b>	EC001825
<b>ETIM 8.0</b>	EC001825
<b>UNSPSC 16.0901</b>	41111613

**Dimensional drawing** (Dimensions in mm (inch))

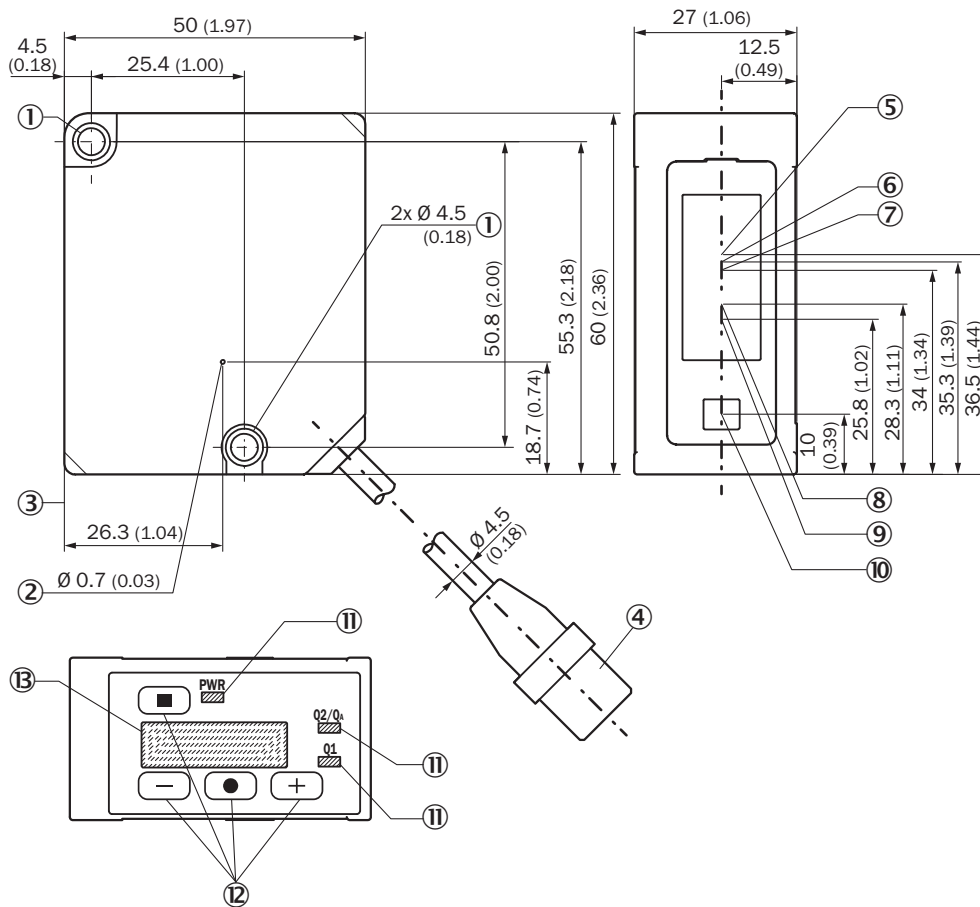

Structure and device dimensions, unit: mm (inch), decimal separator: period

- ① M4 fixing holes
- ② Ventilation opening (do not cover)
- ③ Device zero point (distance = 0 mm)
- ④ Device cable (length: 300 mm) with male connector, M12, 5-pin, A-coded
- ⑤ Center of optical axis, receiver (device type OD2000-350, OD2000-700)
- ⑥ Center of optical axis, receiver (device type OD2000-245)
- ⑦ Center of optical axis, receiver (device type OD2000-130)
- ⑧ Center of optical axis, receiver (device type OD2000-050)
- ⑨ Center of optical axis, receiver (device type OD2000-030)
- ⑩ Center of optical axis, sender
- ⑪ Status LEDs
- ⑫ Control elements
- ⑬ Display

### Interference diagram

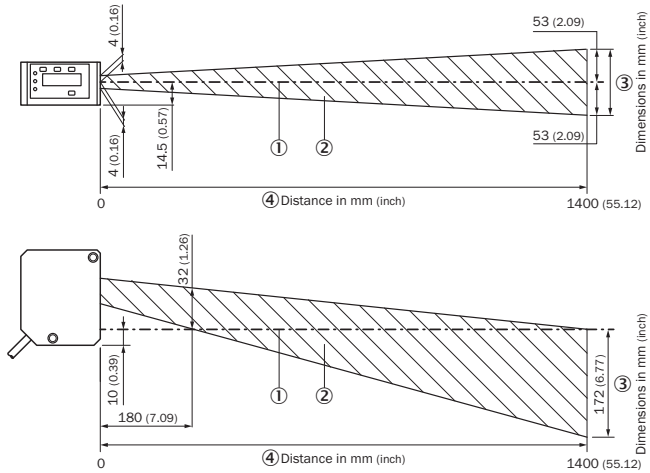

### Connection diagram

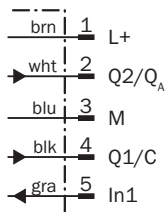

- ① Brown
- ② White
- ③ Blue
- ④ Black
- ⑤ Gray

### Light spot size

Typical light spot size OD2000-700xxx

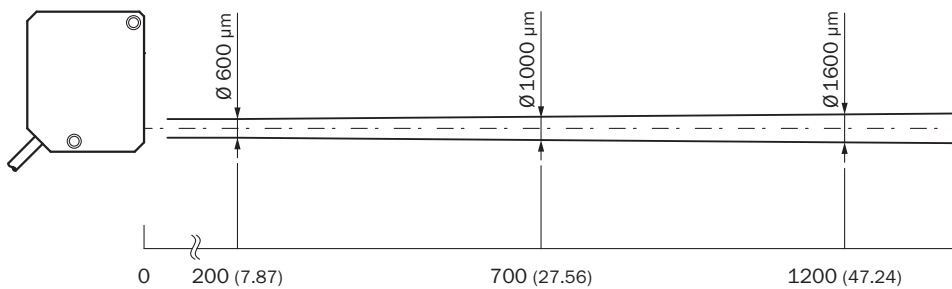

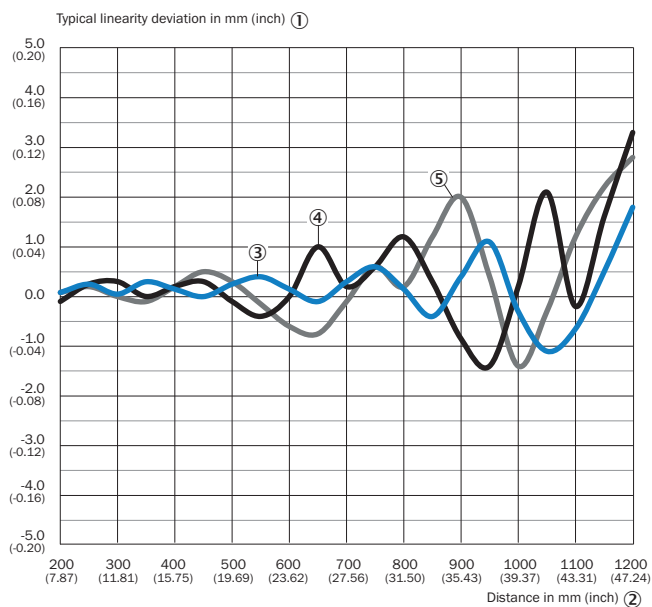

## Linearity



- ① Typical linearity deviation in mm (inch)
- ② Distance in mm (inch)
- ③ White 60% remission factor
- ④ Black 9.5% remission factor
- ⑤ Stainless steel

## Recommended accessories

Other models and accessories → [www.sick.com/OD2000](http://www.sick.com/OD2000)

	Brief description	Type	Part no.
<b>Connection modules</b>			
	IO-Link V1.1 Class A port, USB2.0 port, optional external power supply 24V / 1A	IOLA2US-01101 (SiLink2 Master)	1061790
<b>Mounting brackets and plates</b>			
	Stainless-steel mounting bracket, stainless steel	BEF-WN-OD2000	4112929
<b>Plug connectors and cables</b>			
	Head A: female connector, M12, 5-pin, straight, A-coded Head B: Flying leads Cable: Sensor/actuator cable, PVC, unshielded, 2 m	YF2A15-020VB5XLEAX	2096239

### Recommended services

Additional services → [www.sick.com/OD2000](http://www.sick.com/OD2000)

	Type	Part no.
Extended warranty		
<ul style="list-style-type: none"><li>• <b>Product area:</b> Identification solutions, machine vision, Distance sensors, Detection and ranging solutions</li><li>• <b>Range of services:</b> The services correspond to the scope of the statutory manufacturer warranty (SICK general terms of delivery).</li><li>• <b>Duration:</b> Five-year warranty from delivery date.</li></ul>	Extended warranty for a total of five years from delivery date	1680671



## SICK AT A GLANCE

SICK is one of the leading manufacturers of intelligent sensors and sensor solutions for industrial applications. A unique range of products and services creates the perfect basis for controlling processes securely and efficiently, protecting individuals from accidents and preventing damage to the environment.

We have extensive experience in a wide range of industries and understand their processes and requirements. With intelligent sensors, we can deliver exactly what our customers need. In application centers in Europe, Asia and North America, system solutions are tested and optimized in accordance with customer specifications. All this makes us a reliable supplier and development partner.

Comprehensive services complete our offering: SICK LifeTime Services provide support throughout the machine life cycle and ensure safety and productivity.

For us, that is “Sensor Intelligence.”

## WORLDWIDE PRESENCE:

Contacts and other locations –[www.sick.com](http://www.sick.com)