



# LMS100-10000

LMS1xx

2D LIDAR SENSORS

**SICK**  
Sensor Intelligence.



### Ordering information

Type	Part no.
LMS100-10000	1041113

Other models and accessories → [www.sick.com/LMS1xx](http://www.sick.com/LMS1xx)



### Detailed technical data

#### Features

<b>Task</b>	Measuring - Level Protecting objects - Buildings and grounds Protecting objects - Valuable items Protecting objects - Vehicles Protecting objects - Infrastructure Localizing, navigating and guiding - Localizing Determining position - 2D position determination
<b>Application</b>	Indoor
<b>Light source</b>	Infrared (905 nm)
<b>Laser class</b>	1 (IEC 60825-1:2014, EN 60825-1:2014)
<b>Aperture angle</b>	Horizontal 270°
<b>Scanning frequency</b>	25 Hz 50 Hz
<b>Angular resolution</b>	0.25° 0.5°
<b>Heating</b>	No
<b>Working range</b>	0.5 m ... 20 m
<b>Scanning range</b>	At 10% remission factor 18 m At 90% remission factor 20 m
<b>Amount of evaluated echoes</b>	2
<b>Fog correction</b>	Yes

#### Mechanics/electronics

<b>Connection type</b>	1 x system plug with screw terminal block
<b>Supply voltage</b>	10.8 V DC ... 30 V DC
<b>Power consumption</b>	Typ. 8 W
<b>Housing color</b>	Light blue (RAL 5012)
<b>Enclosure rating</b>	IP65 (EN 60529, Section 14.2.5)

<b>Protection class</b>	III (EN 50178 (1997;10))
<b>Weight</b>	1.1 kg
<b>Dimensions (L x W x H)</b>	105 mm x 102 mm x 152 mm
<b>MTBF</b>	> 100 years

#### Safety-related parameters

<b>MTTF<sub>D</sub></b>	> 100 years
-------------------------	-------------

#### Performance

<b>Response time</b>	≥ 20 ms
<b>Detectable object shape</b>	Almost any
<b>Systematic error</b>	± 30 mm <sup>1)</sup>
<b>Statistical error</b>	12 mm <sup>1)</sup>
<b>Integrated application</b>	Field evaluation
<b>Number of field sets</b>	10 fields
<b>Simultaneous evaluation cases</b>	10

<sup>1)</sup> Typical value; actual value depends on environmental conditions.

#### Interfaces

<b>Ethernet</b>	✓, TCP/IP
Function	Data interface (read result output)
Data transmission rate	10/100 MBit/s
<b>Serial</b>	✓, RS-232
Function	Data interface (read result output), Service interface
Data transmission rate	9.6 kBaud ... 115.2 kBaud
<b>CAN</b>	✓
Function	Extension of outputs
<b>Digital inputs</b>	2 digital and 2 encoder inputs
<b>Digital outputs</b>	3
<b>Optical indicators</b>	7-segment display (plus 5 LEDs showing device status, contamination warning and initial condition)

#### Ambient data

<b>Object remission</b>	2 % ... > 1,000 % (reflectors)
<b>Electromagnetic compatibility (EMC)</b>	EN 61000-6-2:2005 / EN 61000-6-3:2007+A1:2011
<b>Vibration resistance</b>	EN 60068-2-6 (1995-04)
<b>Shock resistance</b>	EN 60068-2-27 (1993-03)
<b>Ambient operating temperature</b>	0 °C ... +50 °C
<b>Storage temperature</b>	-30 °C ... +70 °C
<b>Ambient light immunity</b>	40,000 lx

#### General notes

<b>Note on use</b>	The sensor does not constitute a safety component as defined by relevant legislation on machine safety.
--------------------	---

#### Classifications

<b>ECLASS 5.0</b>	27270990
-------------------	----------

<b>ECLASS 5.1.4</b>	27270990
<b>ECLASS 6.0</b>	27270913
<b>ECLASS 6.2</b>	27270913
<b>ECLASS 7.0</b>	27270913
<b>ECLASS 8.0</b>	27270913
<b>ECLASS 8.1</b>	27270913
<b>ECLASS 9.0</b>	27270913
<b>ECLASS 10.0</b>	27270913
<b>ECLASS 11.0</b>	27270913
<b>ECLASS 12.0</b>	27270913
<b>ETIM 5.0</b>	EC002550
<b>ETIM 6.0</b>	EC002550
<b>ETIM 7.0</b>	EC002550
<b>ETIM 8.0</b>	EC002550
<b>UNSPSC 16.0901</b>	41111615

### Dimensional drawing (Dimensions in mm (inch))

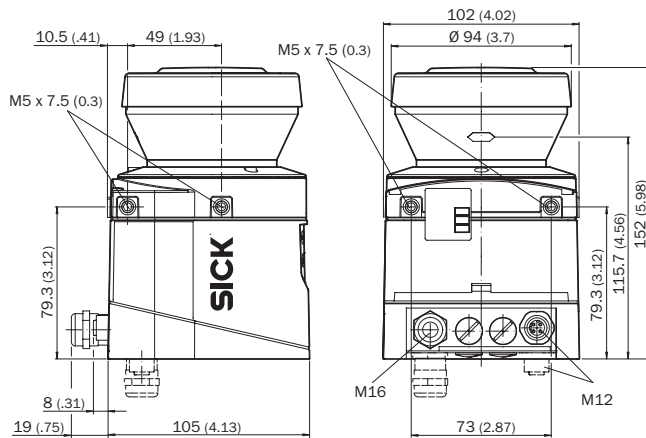

### Working range diagram

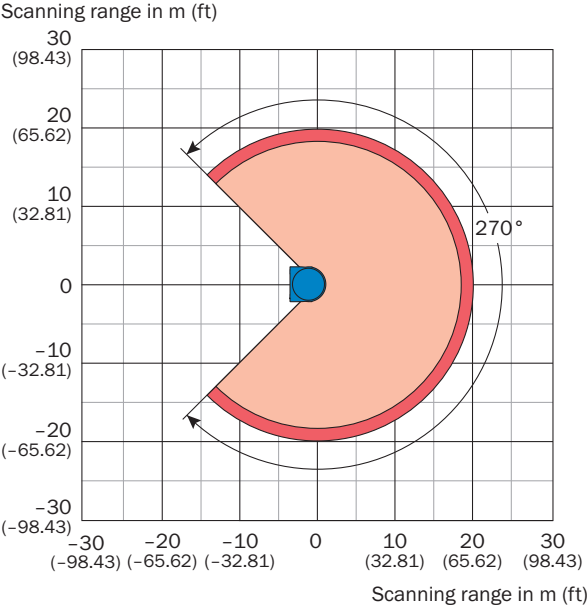

- Scanning range max. 20 m (65.62 ft)
- Scanning range for objects up to 10 % remission 18 m (59.06 ft)

### Connection type

Ethernet

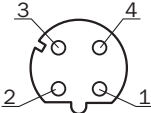

M12 female connector, 4-pin, D-coded

- ① TX+
- ② RX+
- ③ TX-
- ④ RX-

### PIN assignment

Service interface







Female connector M8, 4-pin

- ① Reserved
- ② RxD AUX
- ③ GND RS
- ④ TxD AUX

### Recommended accessories

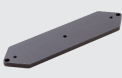
Other models and accessories → [www.sick.com/LMS1xx](http://www.sick.com/LMS1xx)

	Brief description	Type	Part no.
Mounting brackets and plates			
	1 piece, mounting bracket for rear mounting on wall or machine	Mounting kit 1a	2034324
	1 piece, mounting bracket for rear mounting on wall or machine with protection of optics hood	Mounting kit 1b	2034325
	1 piece, mounting bracket, adjustable lateral axis, only in conjunction with mounting kit 1a (2034324) or 1b (2034325)	Mounting kit 2	2039302
	1 piece, mounting plate, adjustable longitudinal axis, only in conjunction with mounting kit 2 (2039302)	Mounting kit 3	2039303
Plug connectors and cables			
	<ul style="list-style-type: none"> <li>• <b>Connection type head A:</b> Male connector, M12, 4-pin, straight, D-coded</li> <li>• <b>Connection type head B:</b> Male connector, RJ45, 4-pin, straight</li> <li>• <b>Signal type:</b> Ethernet, PROFINET</li> <li>• <b>Cable:</b> 5 m, 4-wire, PUR, halogen-free</li> <li>• <b>Description:</b> Ethernet, PROFINET, shielded</li> <li>• <b>Application:</b> Drag chain operation, Zones with oils and lubricants</li> </ul>	YM2D24-050PN1MRJA4	2106184
Others			
	<ul style="list-style-type: none"> <li>• <b>Connection type head A:</b> Flying leads</li> <li>• <b>Connection type head B:</b> Flying leads</li> <li>• <b>Cable:</b> 15-wire, AWG20, PVC</li> <li>• <b>Description:</b> Unshielded</li> <li>• <b>Note:</b> On 100 m reel</li> <li>• <b>Items supplied:</b> By the meter</li> </ul>	Connecting cable	6030795

### Recommended services

Additional services → [www.sick.com/LMS1xx](http://www.sick.com/LMS1xx)

	Type	Part no.
Maintenance		
<ul style="list-style-type: none"> <li>• <b>Product area:</b> 2D LiDAR sensors, 3D LiDAR sensors</li> <li>• <b>Range of services:</b> Inspection, analysis and restoring of defined functions, Inspection and adaptation of basic settings, parameters of field application, filters for raw data output, and product-specific configuration</li> <li>• <b>Duration:</b> Additional work will be invoiced separately</li> </ul>	Maintenance of LiDAR sensors	1682593
Commissioning		
<ul style="list-style-type: none"> <li>• <b>Product area:</b> 2D LiDAR sensors, 3D LiDAR sensors</li> <li>• <b>Range of services:</b> Inspection of connection, fine adjustment, configuration of monitored areas, configuration and optimization of parameters as well as tests, Setup of previously defined functions of basic settings, parameters of field application, filters for raw data output and product-specific configuration</li> <li>• <b>Duration:</b> Additional work will be invoiced separately</li> </ul>	Commissioning LiDAR sensors	1680672

	Type	Part no.
Extended warranty		
<ul style="list-style-type: none"><li>• <b>Product area:</b> Identification solutions, machine vision, Detection and ranging solutions, safety camera sensors, Safety laser scanners, Safety radar sensors</li><li>• <b>Range of services:</b> The services correspond to the scope of the statutory manufacturer warranty (SICK general terms of delivery).</li><li>• <b>Duration:</b> Five-year warranty from delivery date.</li></ul>	Extended warranty for a total of five years from delivery date	1680671

## SICK AT A GLANCE

SICK is one of the leading manufacturers of intelligent sensors and sensor solutions for industrial applications. A unique range of products and services creates the perfect basis for controlling processes securely and efficiently, protecting individuals from accidents and preventing damage to the environment.

We have extensive experience in a wide range of industries and understand their processes and requirements. With intelligent sensors, we can deliver exactly what our customers need. In application centers in Europe, Asia and North America, system solutions are tested and optimized in accordance with customer specifications. All this makes us a reliable supplier and development partner.

Comprehensive services complete our offering: SICK LifeTime Services provide support throughout the machine life cycle and ensure safety and productivity.

For us, that is “Sensor Intelligence.”

## WORLDWIDE PRESENCE:

Contacts and other locations –[www.sick.com](http://www.sick.com)