



CQ4-08EPSKT1
CQ

CAPACITIVE PROXIMITY SENSORS

SICK
Sensor Intelligence.



Illustration may differ

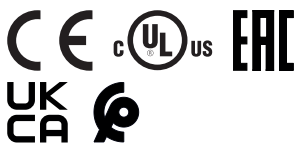

Ordering information

Type	Part no.
CQ4-08EPSKT1	6051004

Other models and accessories → www.sick.com/CQ

Detailed technical data

Features

Housing	Rectangular
Dimensions (W x H x D)	16 mm x 39.5 mm x 12 mm
Sensing range S_n	1 mm ... 8 mm ¹⁾ 1 mm ... 6 mm ²⁾
Safe sensing range S_a	5.76 mm
Installation type	Non-flush Flush
Switching frequency	100 Hz
Connection type	Connector M8, 3-pin
Switching output	PNP
Output function	NO
Electrical wiring	DC 3-wire
Adjustment	Potentiometer, 5 turns (Sensitivity)
Enclosure rating	IP67 ³⁾
Items supplied	Screwdriver for potentiometer adjustment (1 x)

¹⁾ For non-flush installation.

²⁾ For flush mounting.

³⁾ According to EN 60529.

Mechanics/electronics

Supply voltage	10 V DC ... 30 V DC
-----------------------	---------------------

¹⁾ At I_a max.

²⁾ Without load.

³⁾ Depending on installation and environmental conditions and sensitivity adjustment, hysteresis may vary.

⁴⁾ Of S_r .

⁵⁾ Supply voltage U_b and constant ambient temperature T_a .

Ripple	≤ 10 %
Voltage drop	≤ 2.5 V DC ¹⁾
Current consumption	12 mA ²⁾
Time delay before availability	≤ 200 ms
Hysteresis	4 % ... 20 % ³⁾
Reproducibility	≤ 5 % ^{4) 5)}
Temperature drift (of S_r)	± 20 %
EMC	According to EN 60947-5-2
Continuous current I_a	≤ 150 mA
Short-circuit protection	✓
Reverse polarity protection	✓
Power-up pulse protection	✓
Shock and vibration resistance	30 g, 11 ms / 10 ... 55 Hz, 1 mm
Ambient operating temperature	-20 °C ... +75 °C
Ambient temperature, storage	-40 °C ... +85 °C
Housing material	Plastic, ABS
Sensing face material	Plastic
UL File No.	NRKH.E191603

1) At I_a max.

2) Without load.

3) Depending on installation and environmental conditions and sensitivity adjustment, hysteresis may vary.

4) Of S_r.

5) Supply voltage U_b and constant ambient temperature T_a.

Safety-related parameters

MTTF_D	1,344 years
DC_{avg}	0 %
T_M (mission time)	20 years

Reduction factors

Note	The values are reference values which may vary
Metal	1
Water	1
PVC	Approx. 0.4
Oil	Approx. 0.25
Glass	0.6
Ceramics	0.5
Alcohol	0.7
Wood	0.2 ... 0.7

Installation note

Remark	Associated graphic see "Installation"
A	16 mm
B	16 mm

F	48 mm
----------	-------

Classifications

eCl@ss 5.0	27270102
eCl@ss 5.1.4	27270102
eCl@ss 6.0	27270102
eCl@ss 6.2	27270102
eCl@ss 7.0	27270102
eCl@ss 8.0	27270102
eCl@ss 8.1	27270102
eCl@ss 9.0	27270102
eCl@ss 10.0	27270102
eCl@ss 11.0	27270102
eCl@ss 12.0	27274201
ETIM 5.0	EC002715
ETIM 6.0	EC002715
ETIM 7.0	EC002715
ETIM 8.0	EC002715
UNSPSC 16.0901	39122230

Installation note

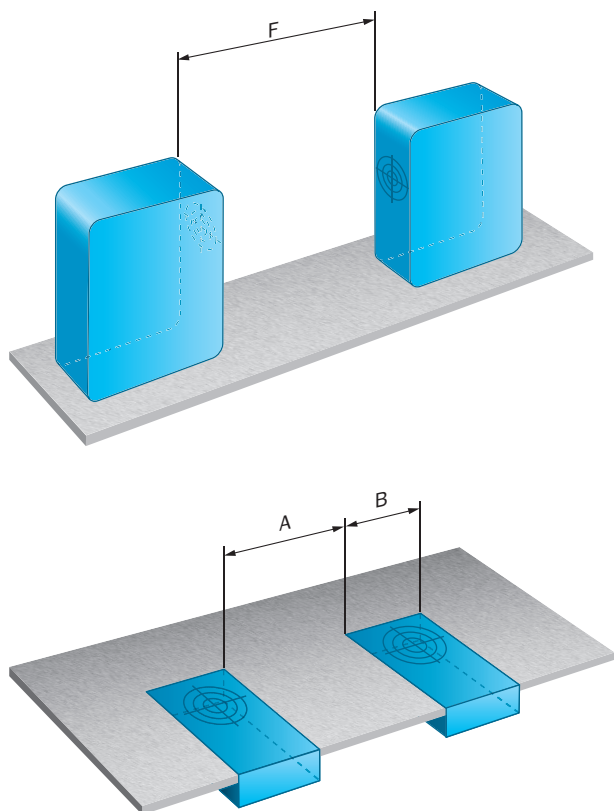

Connection diagram

Cd-045

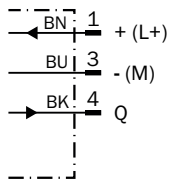

Response diagram

CQ4, Non-flush installation

Distance in mm (inch)

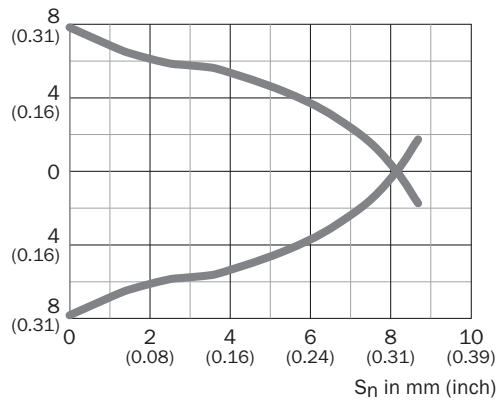

CQ4, Flush installation

Distance in mm (inch)

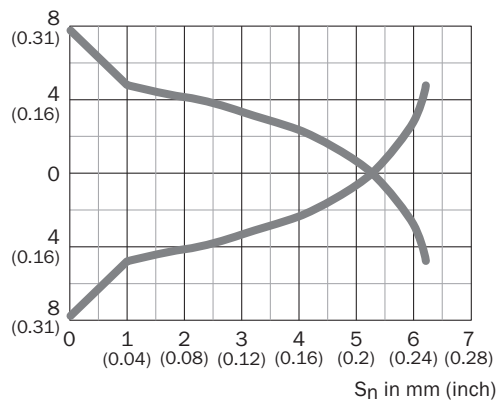

Dimensional drawing (Dimensions in mm (inch))

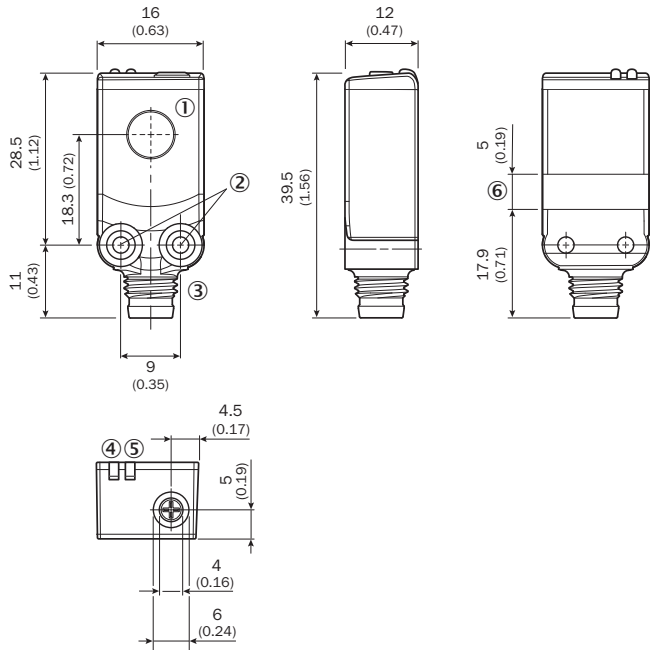

CQ4, connector







- ① Sensing face
- ② Threaded hole M3 (2 x)
- ③ Connector M8, 3-pin
- ④ Yellow LED: status detection of object/medium
- ⑤ LED green: operating indicator
- ⑥ Line for cable tie

Recommended accessories

Other models and accessories → www.sick.com/CQ

	Brief description	Type	Part no.
Mounting brackets and plates			
	Mounting bracket for wall mounting, Stainless steel 1.4571, mounting hardware included	BEF-W4-A	2051628
	Mounting bracket for floor mounting, Stainless steel 1.4571, mounting hardware included	BEF-W4-B	2051630
Plug connectors and cables			
	Head A: female connector, M8, 3-pin, straight, A-coded Head B: Flying leads Cable: Sensor/actuator cable, PVC, unshielded, 2 m	YF8U13-020VA1XLEAX	2095860
	Head A: female connector, M8, 3-pin, straight, A-coded Head B: Flying leads Cable: Sensor/actuator cable, PVC, unshielded, 5 m	YF8U13-050VA1XLEAX	2095884

	Brief description	Type	Part no.
	Head A: female connector, M8, 3-pin, angled, A-coded Head B: Flying leads Cable: Sensor/actuator cable, PVC, unshielded, 2 m	YG8U13-020VA1XLEAX	2096165
	Head A: female connector, M8, 3-pin, angled, A-coded Head B: Flying leads Cable: Sensor/actuator cable, PVC, unshielded, 5 m	YG8U13-050VA1XLEAX	2096166
	Head A: female connector, M8, 3-pin, straight Cable: unshielded	DOS-0803-G	7902077
	Head A: female connector, M8, 3-pin, angled Cable: unshielded	DOS-0803-W	7902078
Terminal and alignment brackets			
	Ball clamp bracket, plastic, mounting hardware included	BEF-GH-MINI01	2023160

SICK AT A GLANCE

SICK is one of the leading manufacturers of intelligent sensors and sensor solutions for industrial applications. A unique range of products and services creates the perfect basis for controlling processes securely and efficiently, protecting individuals from accidents and preventing damage to the environment.

We have extensive experience in a wide range of industries and understand their processes and requirements. With intelligent sensors, we can deliver exactly what our customers need. In application centers in Europe, Asia and North America, system solutions are tested and optimized in accordance with customer specifications. All this makes us a reliable supplier and development partner.

Comprehensive services complete our offering: SICK LifeTime Services provide support throughout the machine life cycle and ensure safety and productivity.

For us, that is “Sensor Intelligence.”

WORLDWIDE PRESENCE:

Contacts and other locations –www.sick.com