



# IMM04-0B6POVU2S

IMM

INDUCTIVE PROXIMITY SENSORS

**SICK**  
Sensor Intelligence.



### Ordering information

Type	Part no.
IMM04-0B6POVU2S	1111252

Other models and accessories → [www.sick.com/IMM](http://www.sick.com/IMM)

Illustration may differ



### Detailed technical data

#### Features

<b>Housing</b>	Cylindrical thread design
<b>Housing</b>	Standard design
<b>Thread size</b>	M4 x 0.5
<b>Diameter</b>	Ø 4 mm
<b>Sensing range <math>S_n</math></b>	0.6 mm
<b>Safe sensing range <math>S_a</math></b>	0.486 mm
<b>Installation type</b>	Flush
<b>Switching frequency</b>	5,000 Hz
<b>Connection type</b>	Cable, 3-wire, 2 m
<b>Switching output</b>	PNP
<b>Output function</b>	NC
<b>Electrical wiring</b>	DC 3-wire
<b>Enclosure rating</b>	IP67 <sup>1)</sup>
<b>Special features</b>	Visual adjustment indicator
<b>Items supplied</b>	Mounting nut, V2A stainless steel (2x) Washer, V2A stainless steel, with locking teeth (2x) Cable flag, Polymatic 50 (1 x)

<sup>1)</sup> According to EN 60529.

#### Mechanics/electronics

<b>Supply voltage</b>	10 V DC ... 30 V DC
<b>Ripple</b>	≤ 20 % <sup>1)</sup>
<b>Voltage drop</b>	≤ 2 V <sup>2)</sup>
<b>Time delay before availability</b>	≤ 10 ms

<sup>1)</sup> Of  $V_S$ .

<sup>2)</sup> With  $I_a = 200$  mA.

<sup>3)</sup> Supply voltage  $U_B$  and constant ambient temperature  $T_a$ .

<b>Hysteresis</b>	1 % ... 15 %
<b>Reproducibility</b>	≤ 2.5 % <sup>3)</sup>
<b>Temperature drift (of S<sub>r</sub>)</b>	≤ 10 %
<b>EMC</b>	EN 60947-5-2
<b>Continuous current I<sub>a</sub></b>	≤ 100 mA
<b>Cable material</b>	PUR
<b>Conductor size</b>	0.08 mm <sup>2</sup>
<b>Cable diameter</b>	Ø 2.5 mm
<b>Short-circuit protection</b>	✓
<b>Reverse polarity protection</b>	✓
<b>Power-up pulse protection</b>	✓
<b>Shock and vibration resistance</b>	30 g, 11 ms / 10 ... 55 Hz, 1 mm
<b>Ambient operating temperature</b>	-25 °C ... +70 °C
<b>Housing material</b>	Stainless steel V2A, DIN 1.4305 / AISI 303
<b>Sensing face material</b>	Plastic, LCP
<b>Housing length</b>	22 mm
<b>Thread length</b>	20 mm
<b>Tightening torque, max.</b>	≤ 0.8 Nm
<b>UL File No.</b>	NRKH.E348498

<sup>1)</sup> Of V<sub>S</sub>.

<sup>2)</sup> With I<sub>a</sub> = 200 mA.

<sup>3)</sup> Supply voltage U<sub>B</sub> and constant ambient temperature T<sub>a</sub>.

### Safety-related parameters

<b>MTTF<sub>D</sub></b>	1,638 years
<b>DC<sub>avg</sub></b>	0 %

### Reduction factors

<b>Note</b>	The values are reference values which may vary
<b>St37 steel (Fe)</b>	1
<b>Stainless steel (V2A, 304)</b>	Approx. 0.68
<b>Aluminum (Al)</b>	Approx. 0.51
<b>Copper (Cu)</b>	Approx. 0.38
<b>Brass (Br)</b>	Approx. 0.64

### Installation note

<b>Remark</b>	Associated graphic see "Installation"
<b>B</b>	0 mm
<b>C</b>	4 mm
<b>D</b>	1.8 mm
<b>F</b>	3 mm

### Classifications

<b>ECLASS 5.0</b>	27270101
-------------------	----------

<b>ECLASS 5.1.4</b>	27270101
<b>ECLASS 6.0</b>	27270101
<b>ECLASS 6.2</b>	27270101
<b>ECLASS 7.0</b>	27270101
<b>ECLASS 8.0</b>	27270101
<b>ECLASS 8.1</b>	27270101
<b>ECLASS 9.0</b>	27270101
<b>ECLASS 10.0</b>	27270101
<b>ECLASS 11.0</b>	27270101
<b>ECLASS 12.0</b>	27274001
<b>ETIM 5.0</b>	EC002714
<b>ETIM 6.0</b>	EC002714
<b>ETIM 7.0</b>	EC002714
<b>ETIM 8.0</b>	EC002714
<b>UNSPSC 16.0901</b>	39122230

### Adjustments

Installation aid

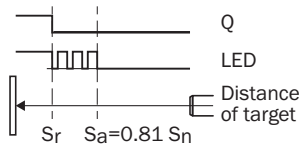

### Installation note

Fixing with setscrew

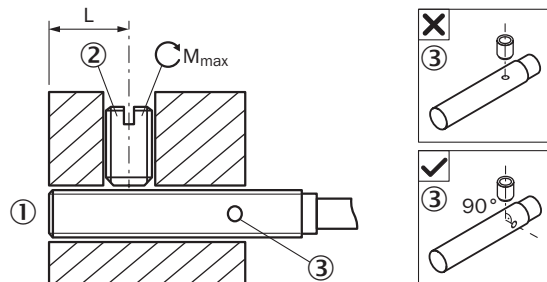

- ① Sensing face
- ② Recommended setscrew: M3, flat point
- ③ Display LED

Sensor type	Mounting area (L)	Max. tightening torque ( $M_{max}$ )
IMM04-01B*****K	5.5 mm ... 9 mm	≤ 0.2 Nm
IMM04-0B6*****S IMM04-01B*****S	5.5 mm ... 19 mm	≤ 0.2 Nm

Mounting using BEF-KH-M04 bracket

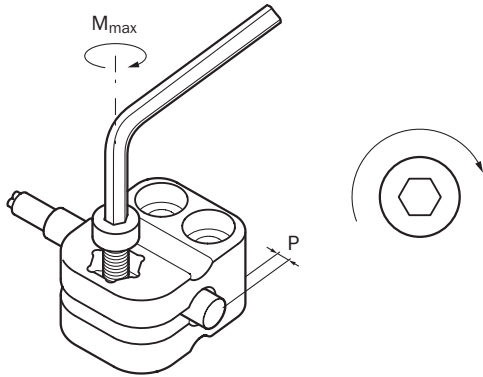

Sensor type	Mounting adapter	Overrun (P)	Max. tightening torque ( $M_{max}$ )
IMM04-0B6***** IMM04-01B*****	BEF-KH-M04, part no. 2101065	$\geq 0$ mm	$\leq 0.6$ Nm

Flush installation

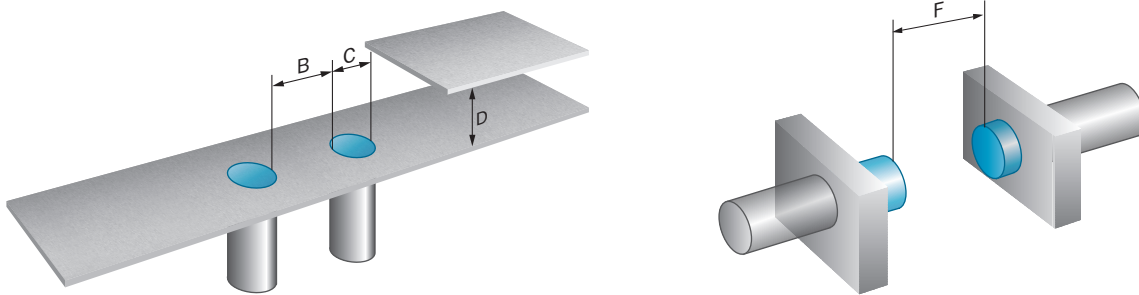

Connection diagram

Cd-003

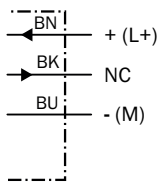

## Response diagram

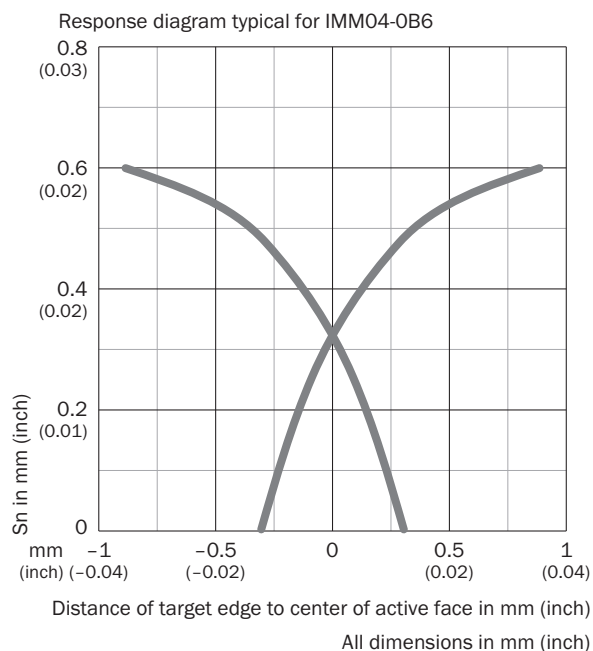

## Dimensional drawing (Dimensions in mm (inch))

IMM04, standard variant, flush, cable

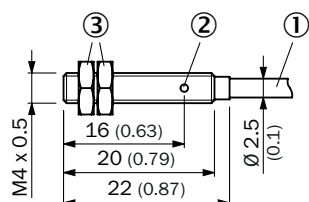







- ① Connection
- ② Function indicator
- ③ Fastening nuts (2 x); 6 mm hex, stainless steel

## Recommended accessories

Other models and accessories → [www.sick.com/IMM](http://www.sick.com/IMM)

	Brief description	Type	Part no.
Distributors			
	<ul style="list-style-type: none"> <li>• <b>Connection type head A:</b> 3-pin</li> <li>• <b>Slot connection type:</b> M8, 3-pin, A-coded, female connector</li> <li>• <b>Description:</b> Unshielded</li> </ul>	Y8A34A2-C2A8000XXX	2115733

	Brief description	Type	Part no.
	<ul style="list-style-type: none"> <li>• <b>Connection type head A:</b> 3-pin</li> <li>• <b>Slot connection type:</b> M8, 3-pin, A-coded, female connector</li> <li>• <b>Cable:</b> 5 m, 6-wire, PUR, halogen-free</li> <li>• <b>Description:</b> Unshielded</li> <li>• <b>Application:</b> Drag chain operation</li> </ul>	Y8A34A2-LXXXUAA050	2115727
	<ul style="list-style-type: none"> <li>• <b>Connection type head A:</b> 3-pin</li> <li>• <b>Slot connection type:</b> M8, 3-pin, A-coded, female connector</li> <li>• <b>Description:</b> Unshielded</li> </ul>	Y8A36A2-C2A8000XXX	2115734
	<ul style="list-style-type: none"> <li>• <b>Connection type head A:</b> 3-pin</li> <li>• <b>Slot connection type:</b> M8, 3-pin, A-coded, female connector</li> <li>• <b>Cable:</b> 5 m, 8-wire, PUR, halogen-free</li> <li>• <b>Description:</b> Unshielded</li> <li>• <b>Application:</b> Drag chain operation</li> </ul>	Y8A36A2-LXXXUBA050	2115728
Plug connectors and cables			
	<ul style="list-style-type: none"> <li>• <b>Connection type head A:</b> Male connector, M8, 3-pin, straight</li> <li>• <b>Description:</b> Unshielded</li> <li>• <b>Connection systems:</b> Screw-type terminals</li> <li>• <b>Permitted cross-section:</b> 0.14 mm<sup>2</sup> ... 0.5 mm<sup>2</sup></li> </ul>	STE-0803-G	6037322
	<ul style="list-style-type: none"> <li>• <b>Connection type head A:</b> Male connector, M8, 3-pin, angled</li> <li>• <b>Description:</b> Unshielded</li> <li>• <b>Connection systems:</b> Screw-type terminals</li> <li>• <b>Permitted cross-section:</b> 0.14 mm<sup>2</sup> ... 0.5 mm<sup>2</sup></li> </ul>	STE-0803-WSK	6053170
Terminal and alignment brackets			
	Plastic (PA6), without mounting hardware	BEF-KH-M04	2101065

## SICK AT A GLANCE

SICK is one of the leading manufacturers of intelligent sensors and sensor solutions for industrial applications. A unique range of products and services creates the perfect basis for controlling processes securely and efficiently, protecting individuals from accidents and preventing damage to the environment.

We have extensive experience in a wide range of industries and understand their processes and requirements. With intelligent sensors, we can deliver exactly what our customers need. In application centers in Europe, Asia and North America, system solutions are tested and optimized in accordance with customer specifications. All this makes us a reliable supplier and development partner.

Comprehensive services complete our offering: SICK LifeTime Services provide support throughout the machine life cycle and ensure safety and productivity.

For us, that is “Sensor Intelligence.”

## WORLDWIDE PRESENCE:

Contacts and other locations –[www.sick.com](http://www.sick.com)