



UM18-212126111

UM18

ULTRASONIC SENSORS

SICK
Sensor Intelligence.



Ordering information

Type	Part no.
UM18-212126111	6048398

Other models and accessories → www.sick.com/UM18



Detailed technical data

Mechanics/electronics

Supply voltage V_s	DC 10 V ... 30 V ¹⁾
Power consumption	≤ 1.2 W ²⁾
Initialization time	< 300 ms
Design	Cylindrical
Housing material	Metal (nickel-plated brass, ultrasonic transducer: polyurethane foam, glass epoxy resin)
Thread size	M18 x 1
Connection type	Male connector, M12, 5-pin
Indication	2 x LED
Weight	25 g
Sending axis	Straight
Dimensions (W x H x D)	18 mm x 18 mm x 52.7 mm
Enclosure rating	IP65 / IP67
Protection class	III

¹⁾ Limit values, reverse-polarity protected Operation in short-circuit protected network: max. 8 A, class 2.

²⁾ Without load.

Safety-related parameters

MTTF_D	101 years
DC_{avg}	0%

Performance

Operating range, limiting range	65 mm ... 350 mm, 600 mm
Target	Natural objects
Resolution	≥ 0.069 mm
Repeatability	± 0.15 % ¹⁾

¹⁾ In relation to the current measured value, minimum value ≥ resolution.

²⁾ Referring to current measurement value.

³⁾ Temperature compensation can be switched off, without temperature compensation: 0.17 % / K.

⁴⁾ Subsequent smoothing of the analog output, depending on the application, may increase the response time by up to 200 %.

Accuracy	$\pm 1\%$ ^{2) 3)}
Temperature compensation	✓
Response time	64 ms ⁴⁾
Output time	16 ms
Ultrasonic frequency (typical)	400 kHz
Additional function	Teach-in of analog output Invertable analog output Multifunctional input: external teach / synchronization / multiplexing Synchronization of up to 20 sensors Multiplexing: no cross talk of up to 20 sensors Reset to factory default

1) In relation to the current measured value, minimum value \geq resolution.

2) Referring to current measurement value.

3) Temperature compensation can be switched off, without temperature compensation: 0.17 % / K.

4) Subsequent smoothing of the analog output, depending on the application, may increase the response time by up to 200 %.

Interfaces

Analog output		
	Number	1
	Type	Current output
	Current	4 mA ... 20 mA, $\leq 500\ \Omega$ ¹⁾
	Resolution	12 bit
Multifunctional input (MF)		1 x MF

1) For 4 mA ... 20 mA and $V_s \leq 20\text{ V}$ max. load $\leq 100\ \Omega$.

Ambient data

Ambient temperature, operation	-25 °C ... +70 °C
Ambient temperature, storage	-40 °C ... +85 °C

Classifications

ECLASS 5.0	27270804
ECLASS 5.1.4	27270804
ECLASS 6.0	27270804
ECLASS 6.2	27270804
ECLASS 7.0	27270804
ECLASS 8.0	27270804
ECLASS 8.1	27270804
ECLASS 9.0	27270804
ECLASS 10.0	27270804
ECLASS 11.0	27270804
ECLASS 12.0	27272806
ETIM 5.0	EC001846
ETIM 6.0	EC001846
ETIM 7.0	EC001846
ETIM 8.0	EC001846
UNSPSC 16.0901	41111960

Dimensional drawing (Dimensions in mm (inch))

UM18-2xxxxx1

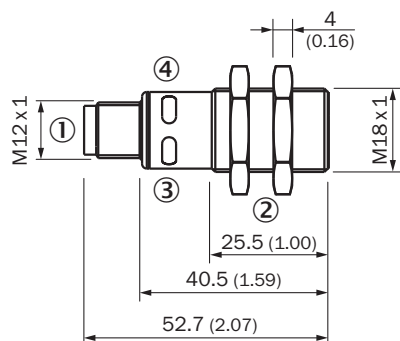

- ① Connection
- ② Fixing nuts, width 24 mm
- ③ Status display for supply voltage active (green)
- ④ Status indicator switching/analog output (orange)

Connection type

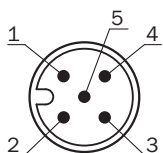

Connection diagram

UM18-21xxx6xxx UM18-21xxx7xxx Connector M12, 5-pin

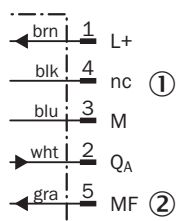

- ① Not assigned
- ② Multifunctional input/synchronization and multiplex operation/communication Connect+

Detection area

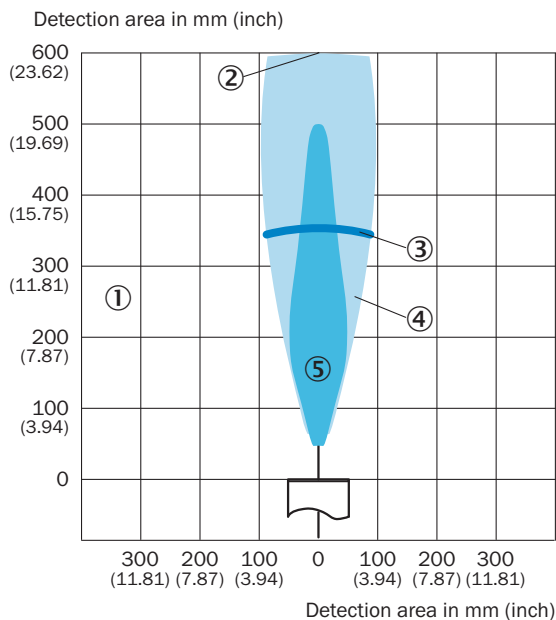

UM18-212



- ① Detection range dependent on reflection properties, size, and alignment of the object
- ② Limiting range
- ③ Operating range
- ④ Example object: aligned plate 500 mm x 500 mm
- ⑤ Example object: pipe with 27 mm diameter

Recommended accessories

Other models and accessories → www.sick.com/UM18

	Brief description	Type	Part no.
Cloning modules			
	Tool for visualization, configuration and cloning, 3-digit LED display, supply voltage: DV 9 V ... 30 V	Connect+ adapter (CPA)	6037782
Deflector mirrors			
	90° sound deflection plate for UM18-1xxxx and UM18-2xxxx, stainless steel, for straight versions	USP-UM18	5323658
Mounting brackets and plates			
	Mounting plate for M18 sensors, steel, zinc coated, without mounting hardware	BEF-WG-M18	5321870

	Brief description	Type	Part no.
Plug connectors and cables			
	<ul style="list-style-type: none"> • Connection type head A: Female connector, M12, 5-pin, straight, A-coded • Connection type head B: Flying leads • Signal type: Sensor/actuator cable • Cable: 2 m, 5-wire, PVC • Description: Sensor/actuator cable, unshielded • Application: Zones with chemicals 	YF2A15-020VB5XLEAX	2096239

SICK AT A GLANCE

SICK is one of the leading manufacturers of intelligent sensors and sensor solutions for industrial applications. A unique range of products and services creates the perfect basis for controlling processes securely and efficiently, protecting individuals from accidents and preventing damage to the environment.

We have extensive experience in a wide range of industries and understand their processes and requirements. With intelligent sensors, we can deliver exactly what our customers need. In application centers in Europe, Asia and North America, system solutions are tested and optimized in accordance with customer specifications. All this makes us a reliable supplier and development partner.

Comprehensive services complete our offering: SICK LifeTime Services provide support throughout the machine life cycle and ensure safety and productivity.

For us, that is “Sensor Intelligence.”

WORLDWIDE PRESENCE:

Contacts and other locations –www.sick.com