

EOS2 1509 XS2

Order Code: 1320549

Body Detection Safety Light Curtain for Cascading Connection with Automatic/Manual Restart and EDM (Secondary Slave)



Safety level

Type 2 - PL c

Protected height (mm)

1510

Resolution (mm)

90

Max. range (m)

12

Restart

Built-in - User selectable automatic or manual

Functioning system

Emitter / Receiver

Master Slave Models

yes

Technical Description

Compact Safety Light Curtain: Type 2, SIL 1, SILCL 1, PL c, Cat. 2

Cross Section: 28 x 30 mm

No blind area on one side

Hardware configuration: no programming necessary, easy to install and replace

Connection and configuration through M12 connectors

Unshielded cables up to 100 m can be used to connect the Safety Light Curtain

What's in the Box: Emitter, Receiver and Standard Fastening Brackets

Features

Safety level	Type 2 - PL c
Protected height (mm)	1510
Resolution (mm)	90
Controlled height (mm)	1500
Max. range (m)	12
Restart	Built-in - User selectable automatic or manual
Functioning system	Emitter / Receiver
Master Slave Models	yes
Safety level (SIL / PL)	Type 2 - SIL 1 - SILCL 1 - PL c - Cat. 2
Operating temperature (°C)	- 30 ... 55
Response time (ms)	See technical manual
Number of beams	20
Max. length of the connection cables (m)	100 (50 between Master and Slave)
Signalling	LEDs for light curtain's status and diagnostics
Safety output type	2 fail-safe PNP (400 mA at 24 VDC) with protection against short circuit, overload and reverse polarity
Connections	M12 5-pole connectors
MTTFD (ISO13849) years	289,7
PFHD (IEC 61508)	3,64E-08
Safety outputs	2 OSSD PNP (400 mA at 24 VDC)
Safety functions	Integrated
Detection	Body

Protective enclosures None

Packaging dimensions HxLxW
(mm) 0 x 0 x 0

Product class C

Custom tariff 85365019

Electrical data

Power supply (VDC) 24 ± 20%

Mechanical data

Overall height (mm) 1586,5

Cross section dimensions (mm) 28 x 30

Degree of protection IP65 - IP67

Fastening Back slot with set of LE type brackets (included) or to the top and lower end with swivel brackets SFB E (optional)

Technical drawings

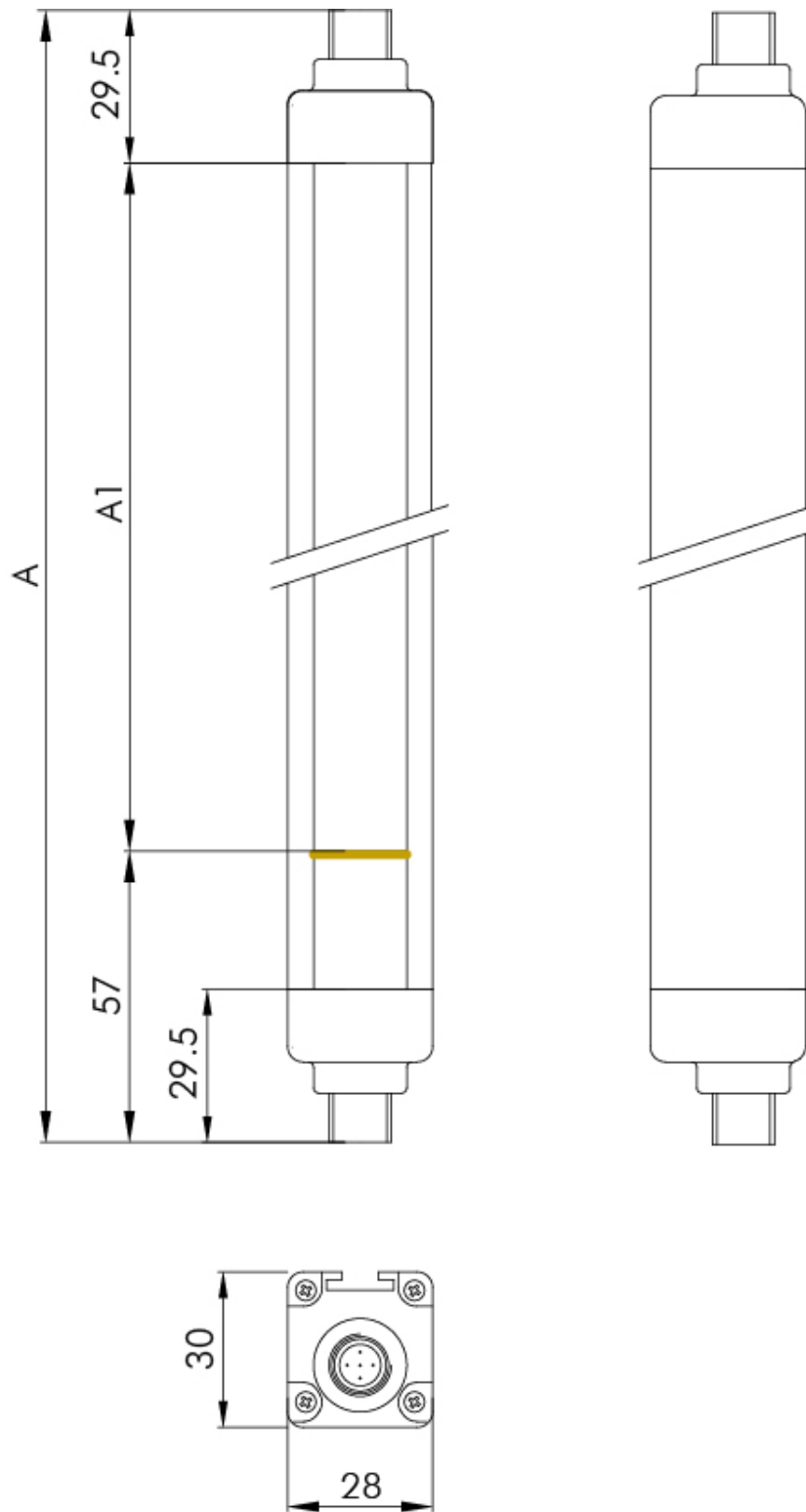

Certificates

