

EOS2 254 XM

Order Code: 1321210

Hand Detection Safety Light Curtain for Cascading Connection with Automatic/Manual Restart and EDM (Master)



Safety level

Type 2 - PL c

Protected height (mm)

260

Resolution (mm)

40

Max. range (m)

12

Restart

Built-in - User selectable automatic or manual

Functioning system

Emitter / Receiver

Master Slave Models

yes

Technical Description

Compact Safety Light Curtain: Type 2, SIL 1, SILCL 1, PL c, Cat. 2

Cross Section: 28 x 30 mm

No blind area on one side

Hardware configuration: no programming necessary, easy to install and replace

Connection and configuration through M12 connectors

Unshielded cables up to 100 m can be used to connect the Safety Light Curtain

What's in the Box: Emitter, Receiver and Standard Fastening Brackets

Features

Safety level	Type 2 - PL c
Protected height (mm)	260
Resolution (mm)	40
Controlled height (mm)	250
Max. range (m)	12
Restart	Built-in - User selectable automatic or manual
Functioning system	Emitter / Receiver
Master Slave Models	yes
Safety level (SIL / PL)	Type 2 - SIL 1 - SILCL 1 - PL c - Cat. 2
Operating temperature (°C)	- 30 ... 55
Response time (ms)	See technical manual
Number of beams	9
Max. length of the connection cables (m)	100 (50 between Master and Slave)
Signalling	LEDs for light curtain's status and diagnostics
Safety output type	2 fail-safe PNP (400 mA at 24 VDC) with protection against short circuit, overload and reverse polarity
Connections	M12 5-pole connector (emitter), M12 8-pole connector (receiver)
MTTFD (ISO13849) years	440,1
PFHD (IEC 61508)	2,29E-08
Safety outputs	2 OSSD PNP (400 mA at 24 VDC)
Safety functions	Integrated

Detection	Hand
Protective enclosures	None
Packaging dimensions HxLxW (mm)	145 x 350 x 200
Product class	C
Custom tariff	85365019

Electrical data

Power supply (VDC)	24 ± 20%
--------------------	----------

Mechanical data

Overall height (mm)	336,5
Cross section dimensions (mm)	28 x 30
Degree of protection	IP65 - IP67
Fastening	Back slot with set of LE type brackets (included) or to the top and lower end with swivel brackets SFB E (optional)
Gross weight (g)	1381,06

Technical drawings

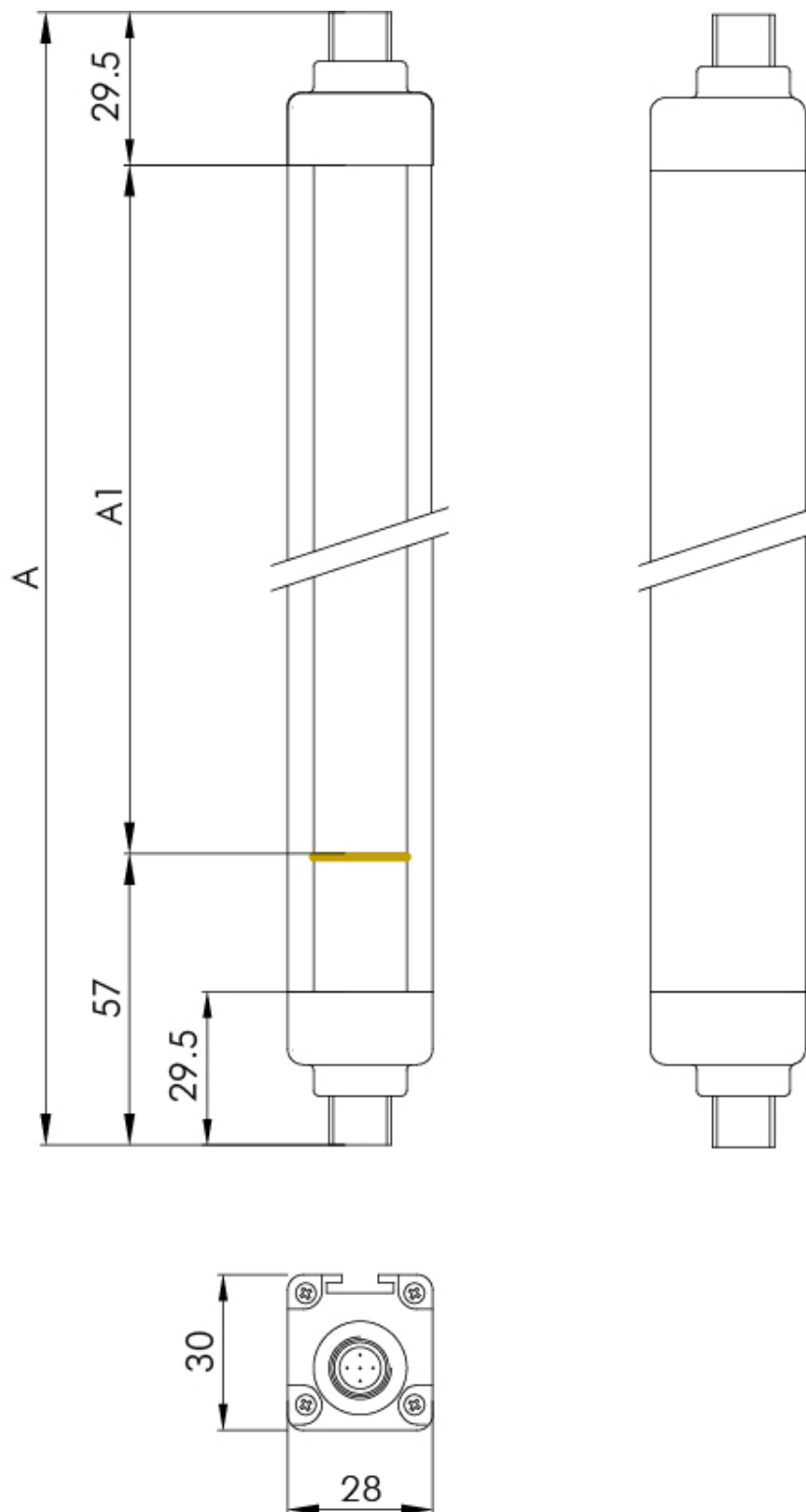

Certificates

