

## EOS2 754 XS2

Order Code: 1320344

Hand Detection Safety Light Curtain for Cascading Connection with Automatic/Manual Restart and EDM (Secondary Slave)



**Safety level**

Type 2 - PL c

**Protected height (mm)**

760

**Resolution (mm)**

40

**Max. range (m)**

12

**Restart**

Built-in - User selectable automatic or manual

**Functioning system**

Emitter / Receiver

**Master Slave Models**

yes

## Technical Description

Compact Safety Light Curtain: Type 2, SIL 1, SILCL 1, PL c, Cat. 2

Cross Section: 28 x 30 mm

No blind area on one side

Hardware configuration: no programming necessary, easy to install and replace

Connection and configuration through M12 connectors

Unshielded cables up to 100 m can be used to connect the Safety Light Curtain

What's in the Box: Emitter, Receiver and Standard Fastening Brackets

## Features

Safety level	Type 2 - PL c
Protected height (mm)	760
Resolution (mm)	40
Controlled height (mm)	750
Max. range (m)	12
Restart	Built-in - User selectable automatic or manual
Functioning system	Emitter / Receiver
Master Slave Models	yes
Safety level (SIL / PL)	Type 2 - SIL 1 - SILCL 1 - PL c - Cat. 2
Operating temperature (°C)	- 30 ... 55
Response time (ms)	See technical manual
Number of beams	26
Max. length of the connection cables (m)	100 (50 between Master and Slave)
Signalling	LEDs for light curtain's status and diagnostics
Safety output type	2 fail-safe PNP (400 mA at 24 VDC) with protection against short circuit, overload and reverse polarity
Connections	M12 5-pole connectors
MTTFD (ISO13849) years	287,4
PFHD (IEC 61508)	3,67E-08
Safety outputs	2 OSSD PNP (400 mA at 24 VDC)
Safety functions	Integrated
Detection	Hand

Protective enclosures	None
Packaging dimensions HxLxW (mm)	145 x 850 x 200
Product class	C
Custom tariff	85365019

## Electrical data

Power supply (VDC)	24 ± 20%
--------------------	----------

## Mechanical data

Overall height (mm)	836,5
Cross section dimensions (mm)	28 x 30
Degree of protection	IP65 - IP67
Fastening	Back slot with set of LE type brackets (included) or to the top and lower end with swivel brackets SFB E (optional)
Gross weight (g)	2548,06

Technical drawings

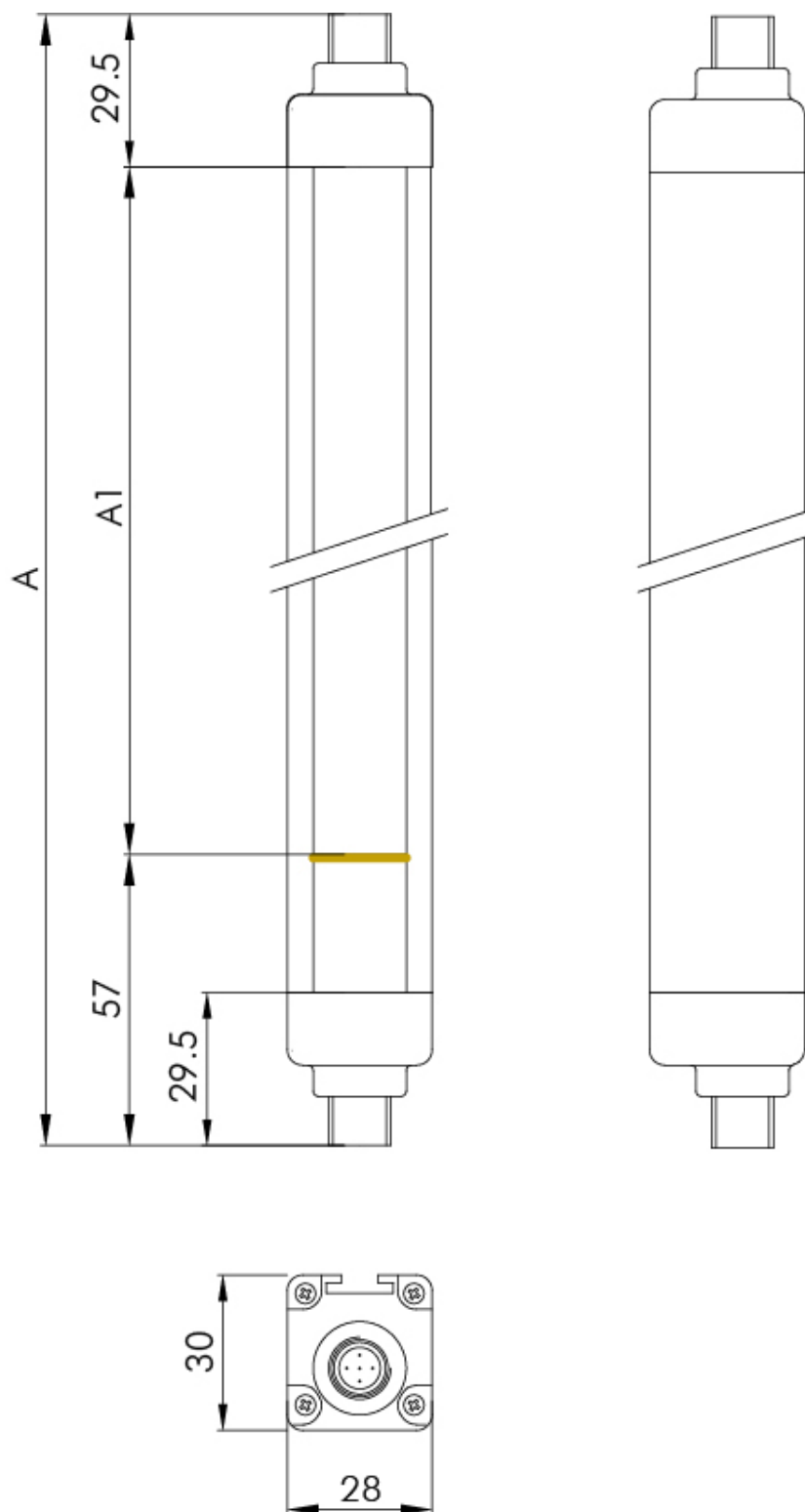

**Certificates**

