

EOS4 301 X WTF

Order Code: 1110031

Finger Detection Safety Light Curtain with Watertight Enclosure. IP69K/Ecolab Certified. Automatic/Manual Restart and EDM. Prewired with 10 m Lead Cable



Safety level

Type 4 - PL e

Protected height (mm)

310

Resolution (mm)

14

Max. range (m)

5

Restart

Built-in - User selectable automatic or manual

Functioning system

Emitter / Receiver

Technical Description

Type 4, SIL 3, SILCL 3, PL e, Cat. 4

Watertight enclosures allow Safety Light Curtains to be used in harsh working environments with exposure to water jets and steam

The use of inert and non-toxic components allow WTF and WTHF enclosures to be used in the Food & Beverage industry, where frequent wash down procedures are required

Integrated anti-condensation system

Hardware configuration: no programming necessary, easy to install and replace

What's in the Box: Emitter, Receiver, Standard Fastening Brackets, Pre-Wired Connection Cable

EOS4 301 X WTF

Features

Safety level	Type 4 - PL e
Protected height (mm)	310
Resolution (mm)	14
Controlled height (mm)	300
Max. range (m)	5
Restart	Built-in - User selectable automatic or manual
Functioning system	Emitter / Receiver
Safety level (SIL / PL)	Type 4 - SIL 3 - SILCL 3 - PL e - Cat. 4
Operating temperature (°C)	0 ... 55
Response time (ms)	4
Number of beams	30
Max. length of the connection cables (m)	100
Signalling	LEDs for light curtain's status and diagnostics
Safety output type	2 fail-safe PNP (400 mA at 24 VDC) with protection against short circuit, overload and reverse polarity
Connections	Cable output
MTTFD (ISO13849) years	100
PFHD (IEC 61508)	1,27E-08
Materials suitable for food applications	Yes
Light curtain technical data	Refer to EOS4 X models table
Safety outputs	2 OSSD PNP (400 mA at 24 VDC)

EOS4 301 X WTF

Safety functions	Integrated
Special versions	Food and beverage, Watertight enclosure
Detection	Finger
Protective enclosures	Food industry IP69K
Packaging dimensions HxLxW (mm)	145 x 610 x 200
Product class	C
Custom tariff	85365019

Electrical data

Power supply (VDC)	24 ± 20%
--------------------	----------

Mechanical data

Overall height (mm)	487
Degree of protection	IP69K
Fastening	Set of 4 ring brackets (included)
Diameter (mm)	56
Max. water pressure (bar)	80 . . . 100
Gross weight (g)	3775,7

Technical drawings

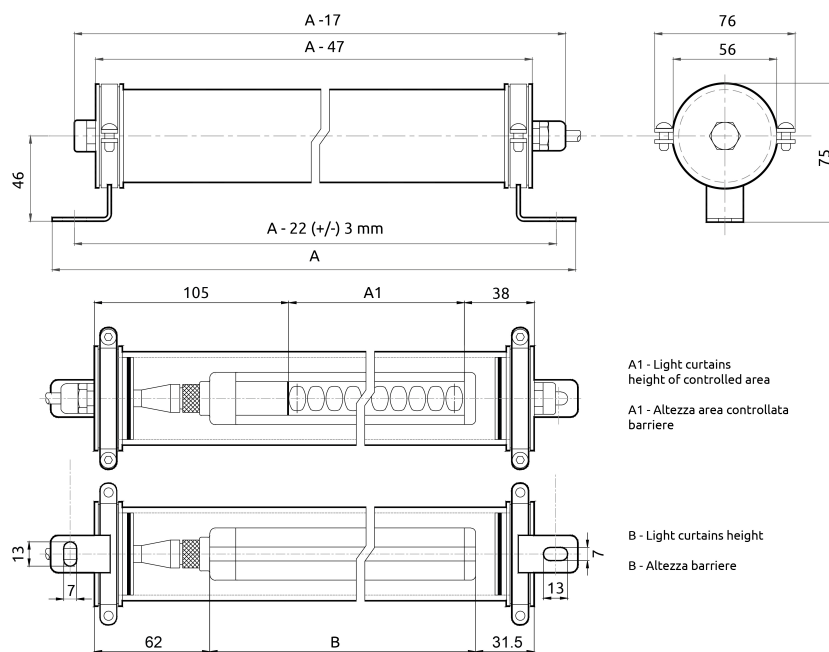

Certificates

