

EOS4 453 XH WTF

Order Code: 1110282

Hand Detection Safety Light Curtain with Watertight Enclosure. IP69K/Ecolab Certified. Automatic/Manual Restart and EDM. Extended Range. Prewired with 10 m Lead Cable



Safety level

Type 4 - PL e

Protected height (mm)

460

Resolution (mm)

30

Max. range (m)

17

Restart

Built-in - User selectable automatic or manual

Functioning system

Emitter / Receiver

Technical Description

Type 4, SIL 3, SILCL 3, PL e, Cat. 4

Watertight enclosures allow Safety Light Curtains to be used in harsh working environments with exposure to water jets and steam

The use of inert and non-toxic components allow WTF and WTHF enclosures to be used in the Food & Beverage industry, where frequent wash down procedures are required

Integrated anti-condensation system

Hardware configuration: no programming necessary, easy to install and replace

What's in the Box: Emitter, Receiver, Standard Fastening Brackets, Pre-Wired Connection Cable

EOS4 453 XH WTF

Features

Safety level	Type 4 - PL e
Protected height (mm)	460
Resolution (mm)	30
Controlled height (mm)	450
Max. range (m)	17
Restart	Built-in - User selectable automatic or manual
Functioning system	Emitter / Receiver
Safety level (SIL / PL)	Type 4 - SIL 3 - SILCL 3 - PL e - Cat. 4
Operating temperature (°C)	0 ... 55
Response time (ms)	5
Number of beams	23
Max. length of the connection cables (m)	100
Signalling	LEDs for light curtain's status and diagnostics
Safety output type	2 fail-safe PNP (400 mA at 24 VDC) with protection against short circuit, overload and reverse polarity
Connections	Cable output
MTTFD (ISO13849) years	100
PFHD (IEC 61508)	1,52E-08
Materials suitable for food applications	Yes
Light curtain technical data	Refer to EOS4 XH models table
Safety outputs	2 OSSD PNP (400 mA at 24 VDC)

EOS4 453 XH WTF

Safety functions	Integrated
Special versions	Food and beverage, Watertight enclosure
Detection	Hand
Protective enclosures	Food industry IP69K
Packaging dimensions HxLxW (mm)	145 x 760 x 200
Product class	C
Custom tariff	85365019

Electrical data

Power supply (VDC)	24 ± 20%
--------------------	----------

Mechanical data

Overall height (mm)	637
Degree of protection	IP69K
Fastening	Set of 4 ring brackets (included)
Diameter (mm)	56
Max. water pressure (bar)	80 . . . 100
Gross weight (g)	4303,2

Technical drawings

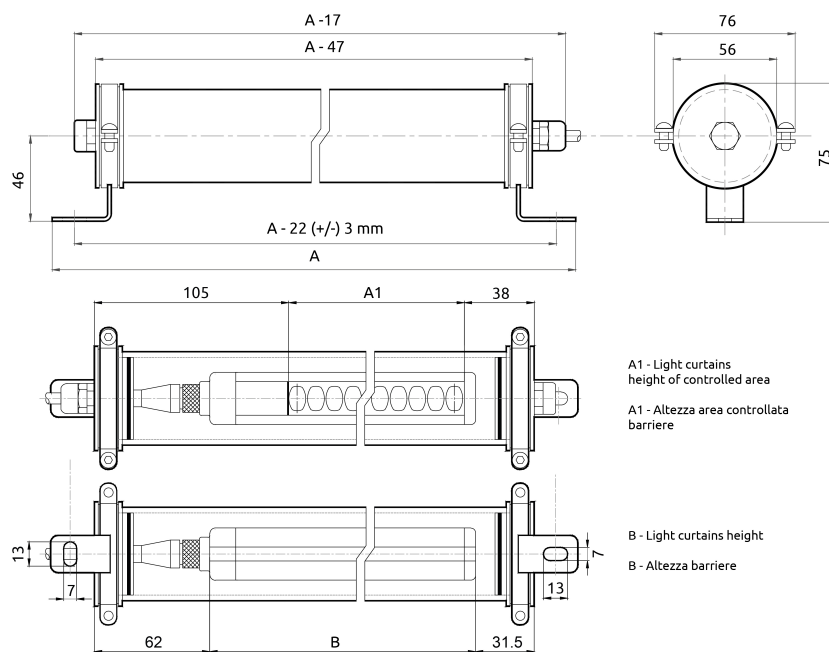

Certificates

