

## **EOS4 4B XH WTF**

Order Code: 1110672

Access Control Safety Light Curtain with Watertight Enclosure. IP69K/Ecolab Certified. Automatic/Manual Restart and EDM. Extended Range. Prewired with 10 m Lead Cable



**Safety level**

Type 4 - PL e

**Protected height (mm)**

910

**Resolution (mm)**

Multi-beams

**Max. range (m)**

17

**Restart**

Built-in - User selectable automatic or manual

**Functioning system**

Emitter / Receiver

## **Technical Description**

Type 4, SIL 3, SILCL 3, PL e, Cat. 4

Watertight enclosures allow Safety Light Curtains to be used in harsh working environments with exposure to water jets and steam

The use of inert and non-toxic components allow WTF and WTHF enclosures to be used in the Food & Beverage industry, where frequent wash down procedures are required

Integrated anti-condensation system

Hardware configuration: no programming necessary, easy to install and replace

What's in the Box: Emitter, Receiver, Standard Fastening Brackets, Pre-Wired Connection Cable

**EOS4 4B XH WTF**

## Features

Safety level	Type 4 - PL e
Protected height (mm)	910
Resolution (mm)	Multi-beams
Max. range (m)	17
Restart	Built-in - User selectable automatic or manual
Functioning system	Emitter / Receiver
Safety level (SIL / PL)	Type 4 - SIL 3 - SILCL 3 - PL e - Cat. 4
Operating temperature (°C)	0 ... 55
Response time (ms)	2,5
Number of beams	4
Max. length of the connection cables (m)	100
Signalling	LEDs for light curtain's status and diagnostics
Safety output type	2 fail-safe PNP (400 mA at 24 VDC) with protection against short circuit, overload and reverse polarity
MTTFD (ISO13849) years	100
PFHD (IEC 61508)	1,08E-08
Materials suitable for food applications	Yes
Light curtain technical data	Refer to EOS4 XH models table
Safety outputs	2 OSSD PNP (400 mA at 24 VDC)
Safety functions	Integrated
Special versions	Food and beverage, Watertight enclosure

## EOS4 4B XH WTF

Detection	Access control
Protective enclosures	Food industry IP69K
Packaging dimensions HxLxW (mm)	145 x 1300 x 200
Product class	C
Custom tariff	85365019

## Electrical data

Power supply (VDC)	24 ± 20%
--------------------	----------

## Mechanical data

Overall height (mm)	1177
Degree of protection	IP69K
Fastening	Set of 4 ring brackets (included)
Max. water pressure (bar)	80 . . . 100
Gross weight (g)	6081,6

Technical drawings

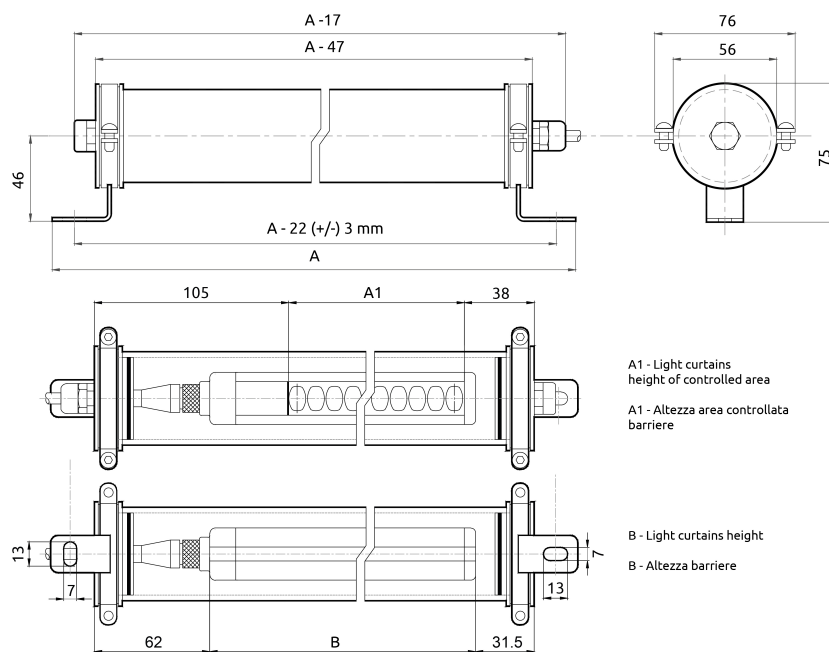

**Certificates**

